

### Features

- LO 2 TO 18 GHz
- RF 1 TO 18 GHz
- IF 0.03 TO 5 GHz
- LO DRIVE: +13 dBm (NOMINAL)
- WIDE BANDWIDTH

### Description

M83 is a triple balanced mixer, designed for use in military, commercial and test equipment applications. The design utilizes Schottky ring quad diodes and broadband soft dielectric baluns to attain excellent performance. The use of high temperature solder assembly processes used internally makes it ideal for use in manual, semi-automated assembly. Environmental screening available to MIL-STD-883, MIL-STD-202 or MIL-DTL-28837, consult factory.

### Product Image

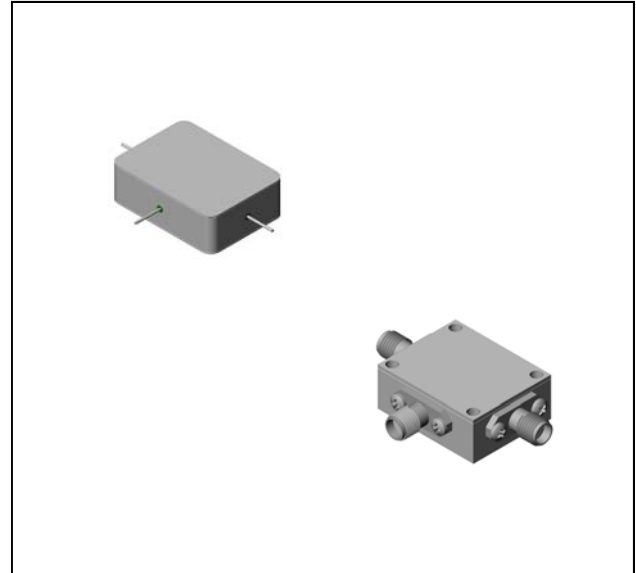

### Ordering Information

Part Number	Package
M83	Minpac
M83C	SMA Connectorized

### Electrical Specifications: $Z_0 = 50\Omega$ $Lo = +13$ dBm (Downconverter Application only)

Parameter	Test Conditions	Units	Typical	Guaranteed	
				+25°C	-54° to +85°C
SSB Conversion Loss (max) & SSB Noise Figure (max)	fR = 5 to 13 GHz, fL = 5 to 13 GHz, fl = 0.03 to 2 GHz fR = 2 to 16 GHz, fL = 2 to 18 GHz, fl = 0.03 to 4 GHz fR = 1 to 18 GHz, fL = 2 to 18 GHz, fl = 0.03 to 5 GHz	dB	6.5	8.0	8.5
			7.5	9.0	9.5
			8.5	10.0	10.5
Isolation, L to R (min)	fL = 2 to 3 GHz fL = 3 to 18 GHz	dB	20	16	14
			30	18	16
Isolation, L to I (min)	fL = 2 to 18 GHz	dB	30	20	18
1 dB Conversion Comp.	fL = +13 dBm	dBm	+6		
Input IP3	fR1 = 6 GHz at -3 dBm, fR2 = 3.01 GHz at -3 dBm, fL = 8 GHz at +13 dBm fR1 = 15 GHz at -3 dBm, fR2 = 15.01 GHz at -3 dBm, fL = 18 GHz at +13 dBm	dBm	+18		
			+19		

### Typical Performance Curves

Conversion Loss vs. LO Drive Power

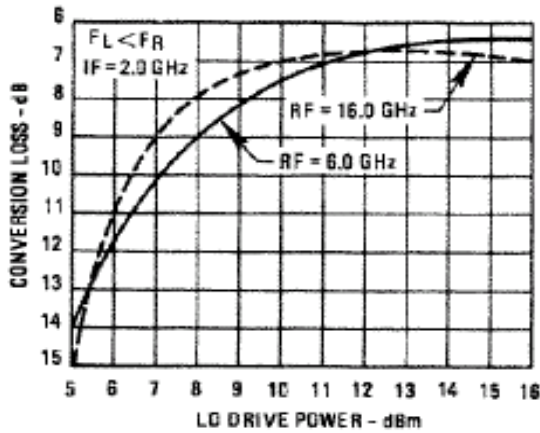

Conversion Loss

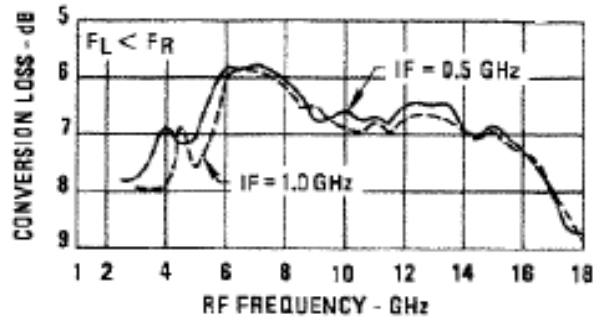

Conversion Loss

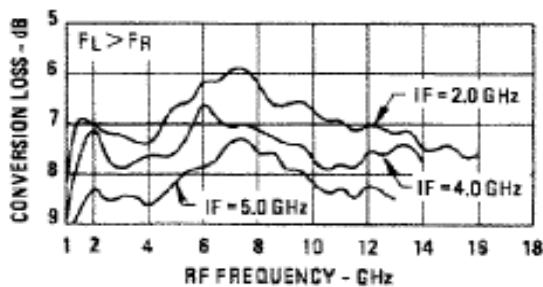
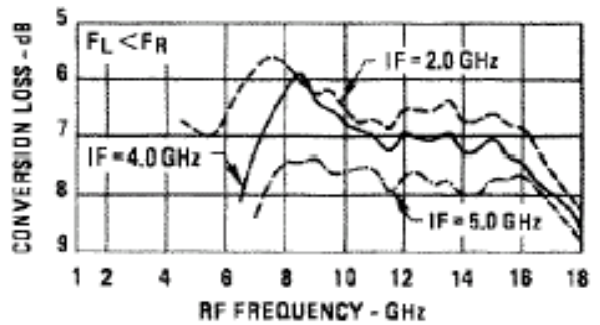
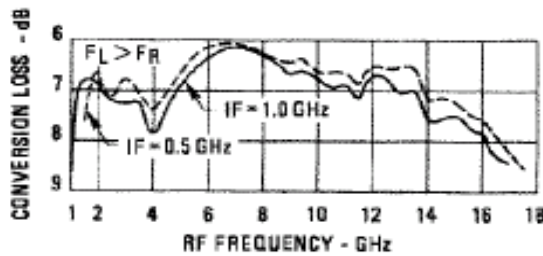

Isolation

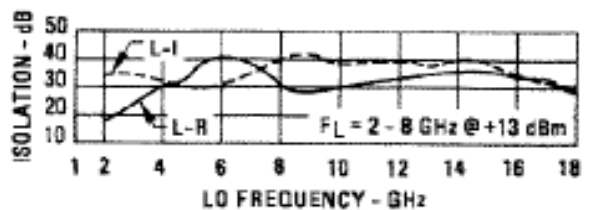

### Absolute Maximum Ratings

Parameter	Absolute Maximum
Operating Temperature	-54°C to +100°C
Storage Temperature	-65°C to +100°C
Peak Input Power	+26 dBm max @ +25°C +23 dBm max @ +100°C
Peak Input Current	100 mA DC

### Outline Drawing: Minpac \*

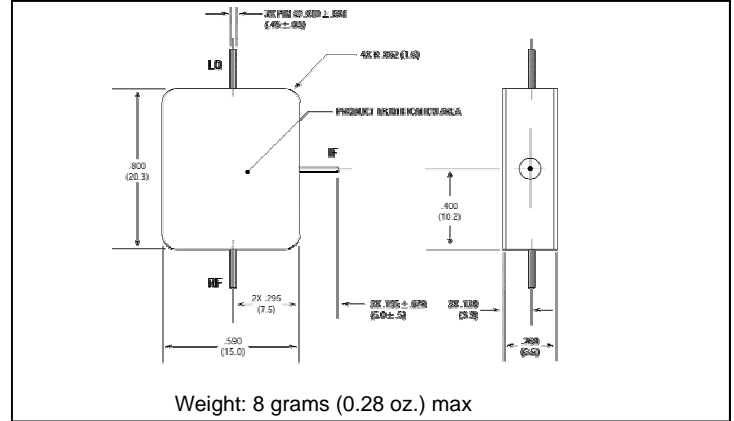

### Outline Drawing: SMA Connectorized \*

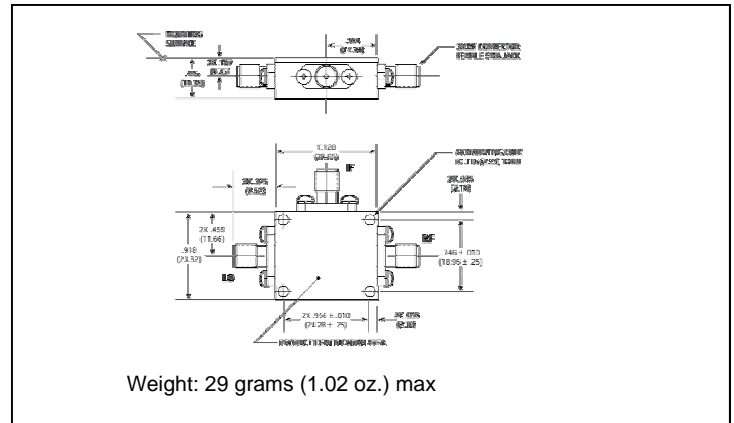

### R-Port VSWR

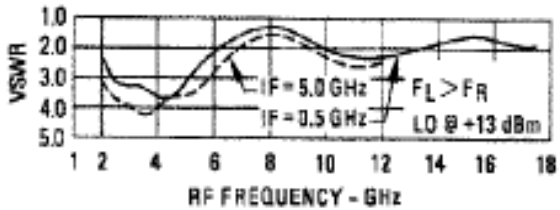
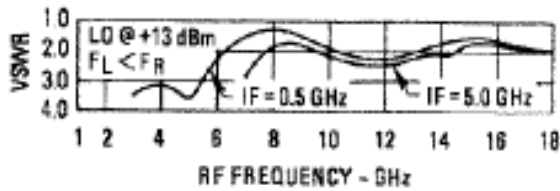

### I-Port VSWR

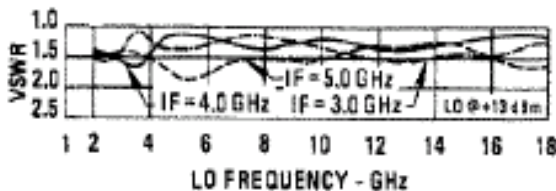
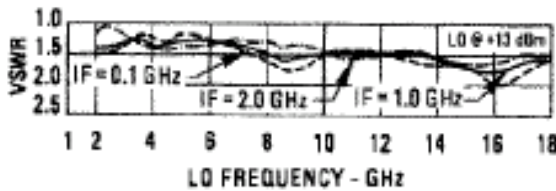

### L-Port VSWR

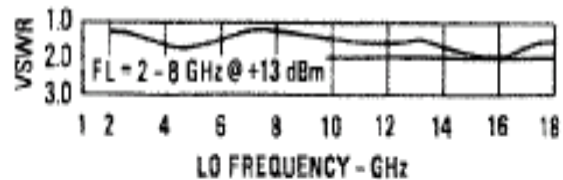

\* Dimensions are inches (millimeters) ±0.015 (0.38) unless otherwise specified.