

856879

782/751 MHz Duplexer

Applications

- For Band 13 LTE applications
- LTE B13 handset, data cards, mobile routers

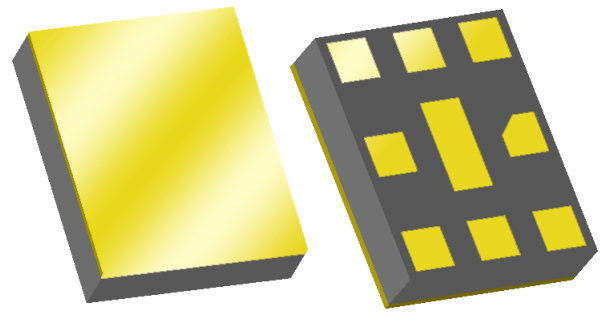

Product Features

- High Rejection in Band 14
- Usable bandwidth 10 MHz
- High Tx-Rx Isolation
- Low loss (or High attenuation)
- Superior Amplitude / Phase Balance
- Single-ended- Balanced Rx operation
- Ceramic chip-scale Hermetic Package (CSP)
- Small Size: 2.5 x 2.00 x 0.56 mm
- Hermetic **RoHS** compliant, **Pb-free**

General Description

The 856879 is a high-performance Temperature Compensated Surface Acoustic Wave (TC SAW) duplexer designed to meet the strict LTE requirements for use in Band 13.

856879 is specifically designed to meet the high performance expectations of insertion loss, isolation and BC14 rejection in LTE systems operating in B13 applications under all operating condition. The use of TC SAW technology guarantees these specifications up to the extended +90C operating condition.

The 856879 uses common packaging techniques to achieve the industry standard 2.5 x 2.0 mm footprint. The duplexer exhibits excellent power handling capabilities.

Functional Block Diagram

TopView

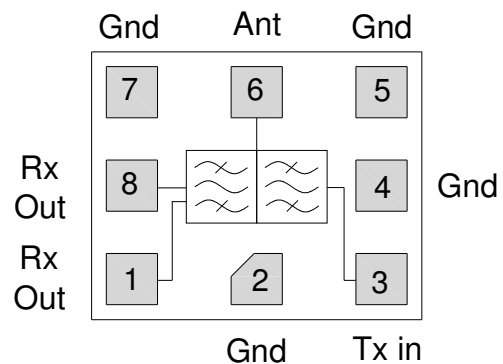

Pin Configuration

Pin #	Balanced	Description
1, 8		Rx Output
3		Tx Input
6		Antenna/Phasing Inductor
2, 4, 5, 7, 9		Ground

Ordering Information

Part No.	Description
856879	Packaged Part
856879-EVB	Evaluation Board

Standard T/R size = 10,000 units/reel.

Specifications

Tx - Electrical Specifications ⁽¹⁾

 Specified Temperature Range: ⁽²⁾ -30 to +90 °C

Parameter ⁽³⁾	Conditions	Min	Typical ⁽⁴⁾	Max	Units
Center Frequency		-	782	-	MHz
Maximum Insertion Loss	777 – 787 MHz	-	2.2	2.5	dB
Amplitude/Passband Variation ⁽⁵⁾	777 – 787 MHz	-	0.75	1.2	dB p-p
Rejection/Attenuation ⁽⁶⁾	10 – 716 MHz	32	37	-	dB
	716 – 728 MHz	36	39	-	dB
	728 – 746 MHz	35	41	-	dB
	746 – 756 MHz	47	51	-	dB
	758 – 767 MHz	37	43	-	dB
	767 – 768 MHz	30	36	-	dB
	768 – 769 MHz	15	25	-	dB
	769 – 770 MHz	6	13	-	dB
	770 – 771 MHz	4	7	-	dB
	771 – 772 MHz	2	5	-	dB
	869 – 894 MHz	35	38	-	dB
	1554 – 1565 MHz	41	45	-	dB
	1565 – 1585 MHz	40	46	-	dB
	1597 – 1607 MHz	40	45	-	dB
	1805 – 1880 MHz	40	47	-	dB
	1930 – 1990 MHz	40	46	-	dB
2110 – 2170 MHz	40	46	-	dB	
2331 – 2361 MHz	38	53	-	dB	
2400 – 2484 MHz	38	50	-	dB	
3108 – 3148 MHz	35	45	-	dB	
Return Loss at Tx	777 – 787 MHz	10	19	-	dB
Return Loss at Antenna	777 – 787 MHz	10	15	-	dB
Power Handling (Power at Tx Port)		-	-	29	dBm
Tx Impedance (single-ended) ⁽⁷⁾		-	50	-	Ω
Antenna Impedance (single-ended) ⁽⁷⁾		-	50	-	Ω
Antenna Impedance (single-ended) ⁽⁷⁾		-	50	-	Ω

Tx – Rx Specification

Tx to Rx Isolation	777 – 787 MHz (Differential)	55	62	-	dB
	777 – 787 MHz (Common Mode Rejection)	60	65	-	dB
	746 – 749 MHz	50	55	-	dB
	749 – 752 MHz	50	57	-	dB
	752 – 756 MHz	53	58	-	dB
	1552 – 1574 MHz	60	74	-	dB
	2328 – 2361 MHz	60	70	-	dB
	3104 – 3148 MHz	50	60	-	dB

Notes:

- All specifications are based on the TriQuint schematic for the main reference design shown on page 7
- In production, devices will be tested at room temperature to a guardbanded specification to ensure electrical compliance over temp.
- Electrical margin has been built into the design to account for the variations due to temperature drift and manufacturing tolerances
- Typical values are based on average measurements at room temperature
- Over a sliding 5 MHz window, in-band
- Relative to zero dB
- This is the optimum impedance in order to achieve the performance shown

Specifications

Rx - Electrical Specifications ⁽¹⁾

Specified Temperature Range: ⁽²⁾ -30 to +90 °C

Parameter ⁽³⁾	Conditions	Min	Typical ⁽⁴⁾	Max	Units
Center Frequency		-	751	-	MHz
Maximum Insertion Loss	746 – 756 MHz	-	1.85	2.5	dB
Amplitude/Passband Variation ⁽⁵⁾	746 – 756 MHz	-	0.4	1.1	dB p-p
Rejection/Attenuation ⁽⁶⁾	650 – 729 MHz	27	31	-	dB
	729 – 736 MHz	27	30	-	dB
	777 – 787 MHz	55	60	-	dB
	793 – 805 MHz	33	39	-	dB
	805 – 3200 MHz	22	27	-	dB
	3200 – 4200 MHz	30	35	-	dB
	4200 – 6000 MHz	13	27	-	dB
Return Loss at Rx	746 – 756 MHz	10	15	-	dB
Return Loss at Antenna	746 – 756 MHz	10	17	-	dB
Output Phase Balance	746 – 756 MHz	-5	-	+5	degree
Output Amplitude Balance	746 – 756 MHz	-1.0	-	1.0	dB
IMR2 ^{(7) (a,b)}		-	-110	-106	dBm
IMR3 ^{(7) (c,d)}		-	-120	-109	dBm
Rx Impedance (balanced) ⁽⁸⁾		-	100	-	Ω
Antenna Impedance (single-ended) ⁽⁸⁾		-	50	-	Ω

Notes:

- All specifications are based on the TriQuint schematic for the main reference design shown on page 7
- In production, devices will be tested at room temperature to a guardbanded specification to ensure electrical compliance over temp
- Electrical margin has been built into the design to account for the variations due to temperature drift and manufacturing tolerances
- Typical values are based on average measurements at room temperature
- Over a sliding 5 MHz window, in-band
- Relative to zero dB
- All power levels are referenced to the antenna port. Two CW tones are applied at frequencies f1 and f2, and the resultant intermodulation product in the Rx band is measured. The first tone is applied to the Tx port, in the range f1 = 777 to 787 MHz, at +21.5 dBm (referenced to the antenna port). The second tone is -15 dBm, applied to the antenna port at f2, with the following four cases:
 - f2 = 31 MHz
 - f2 = 2 * f1 - 31 MHz
 - f2 = f1 + 31 MHz
 - f2 = 3 * f1 - 31 MHz
The intermodulation product is measured at f1 - 31 MHz.
- This is the optimum impedance in order to achieve the performance shown

856879

782/751 MHz Duplexer

Tx - Typical Performance (at room temperature)

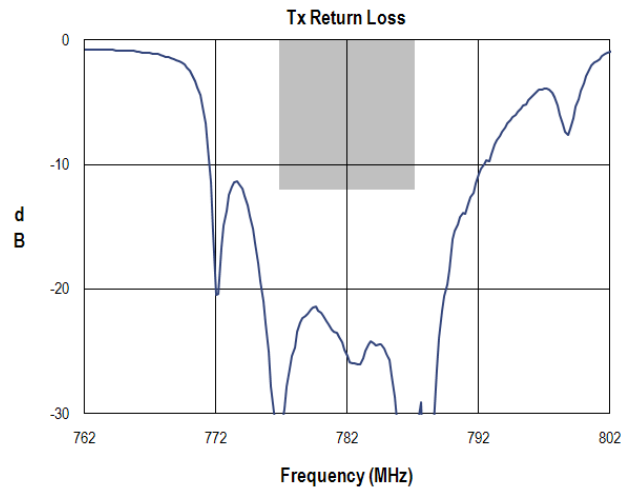
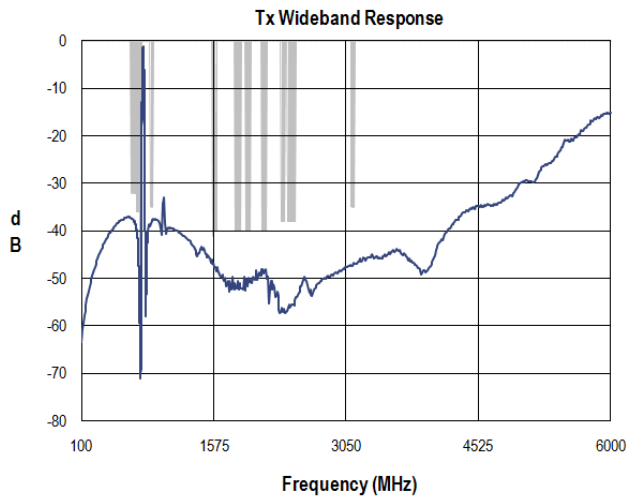
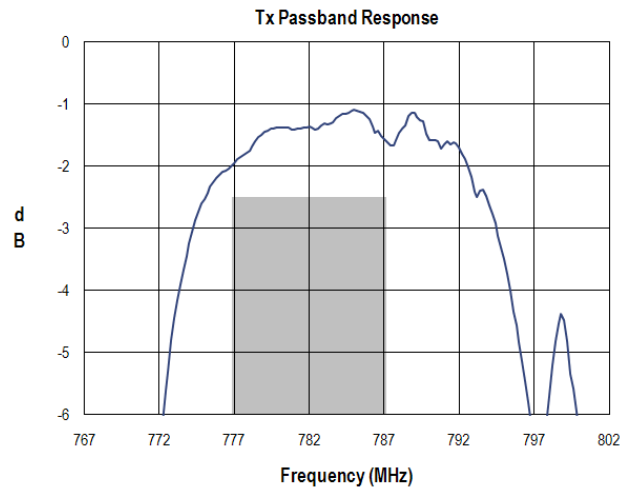
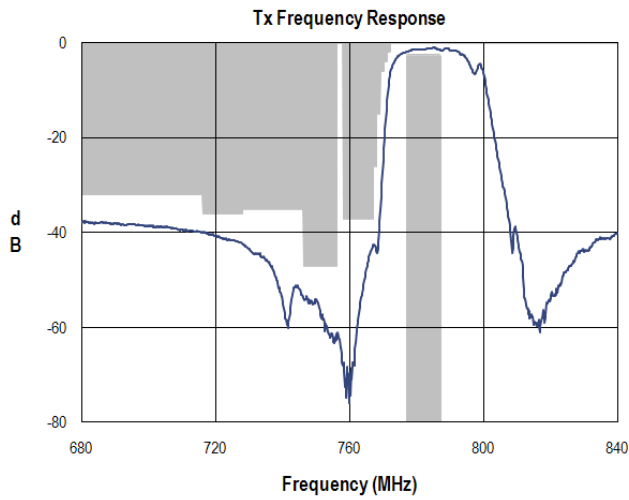

Tx Path - Ant Port Impedance

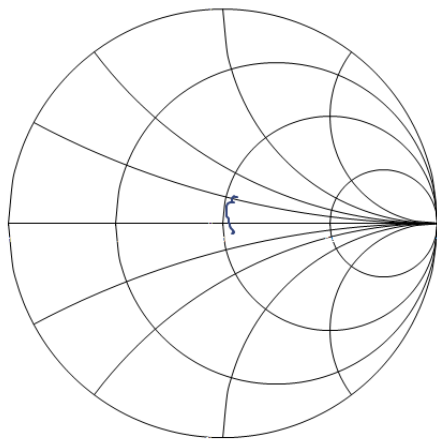

Tx Port Impedance

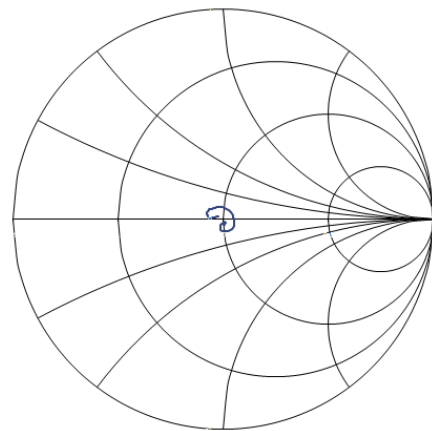

856879

782/751 MHz Duplexer

Rx - Typical Performance (at room temperature)

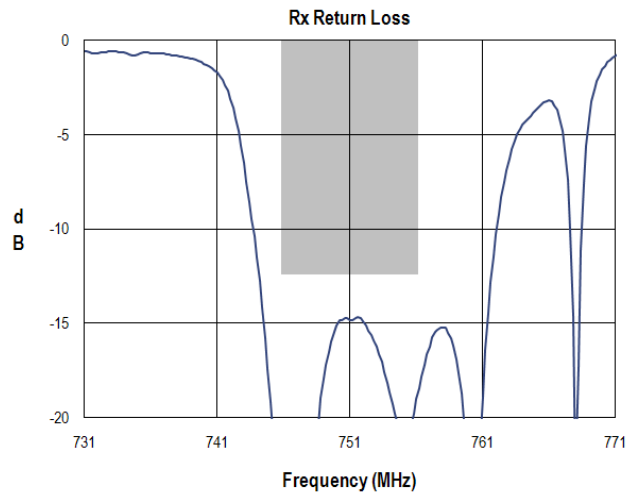
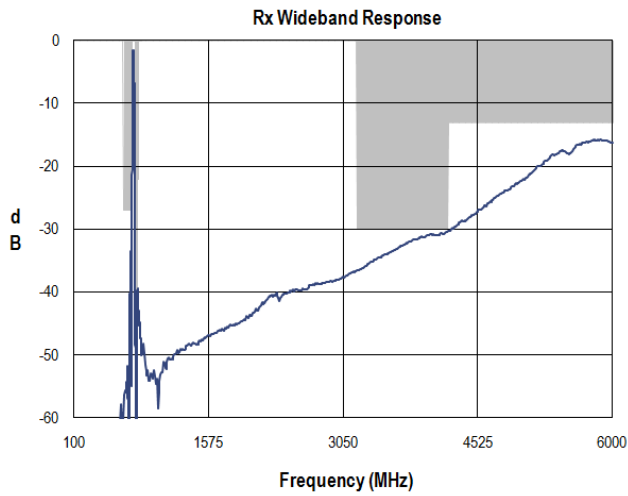
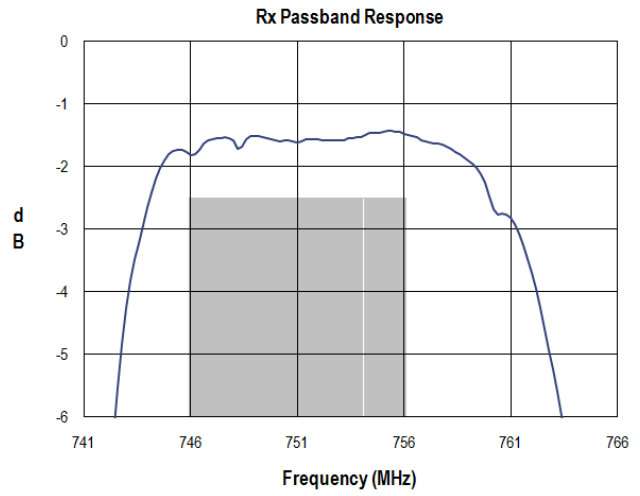
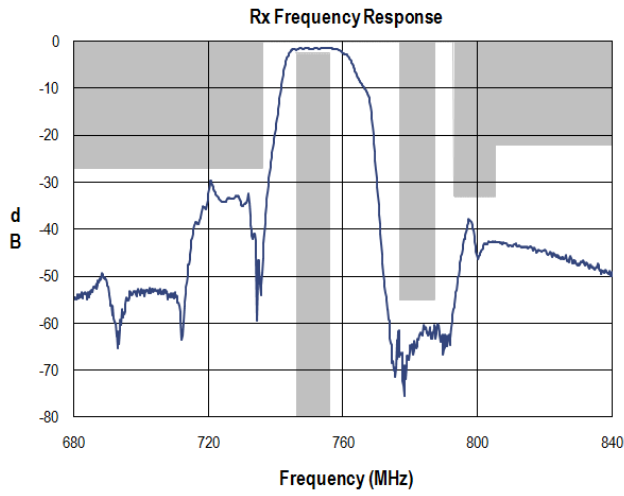

Rx Path - Ant Port Impedance

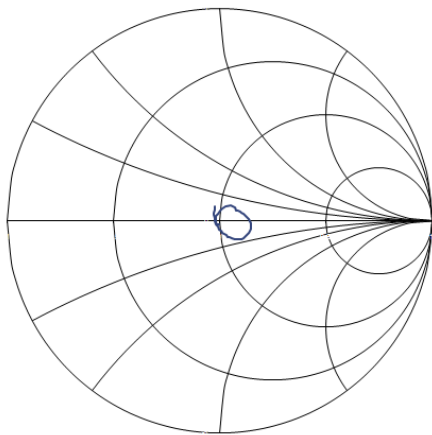

Rx Port Impedance

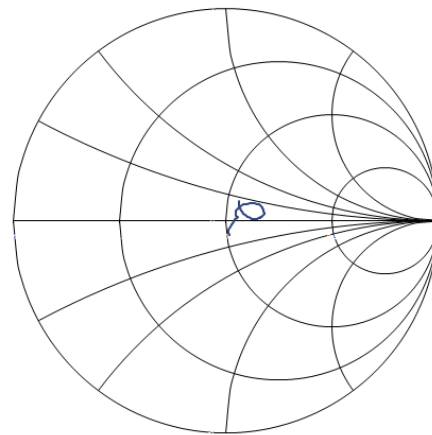

856879

782/751 MHz Duplexer

Tx - Rx Isolation - Typical Performance (at room temperature)

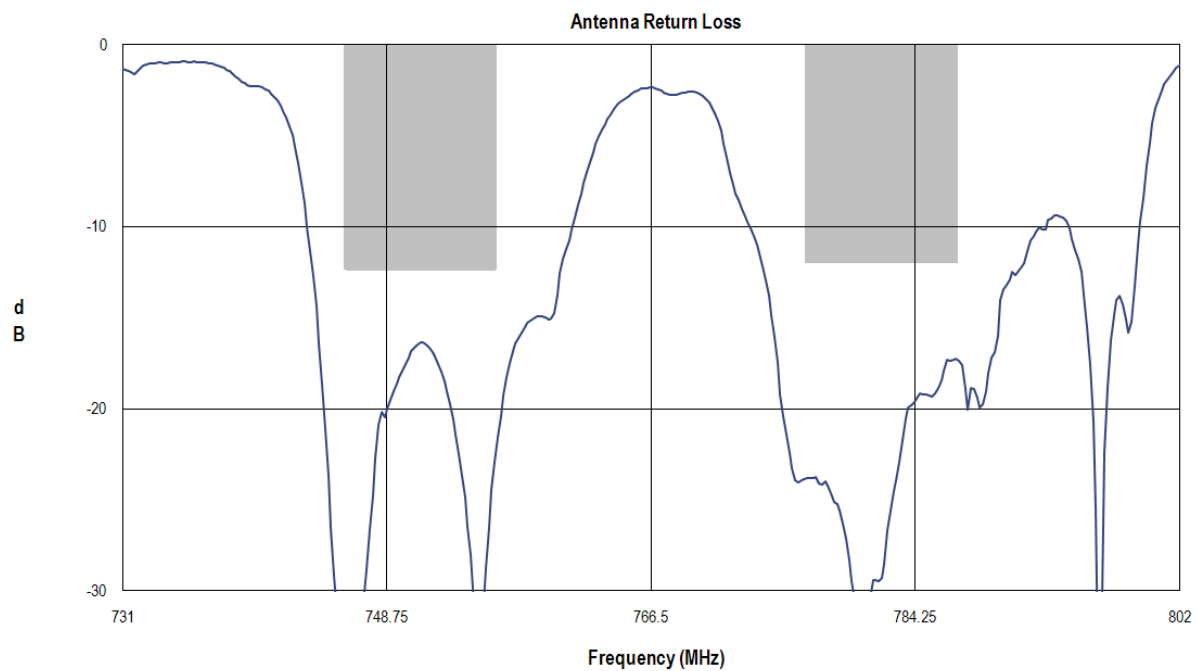
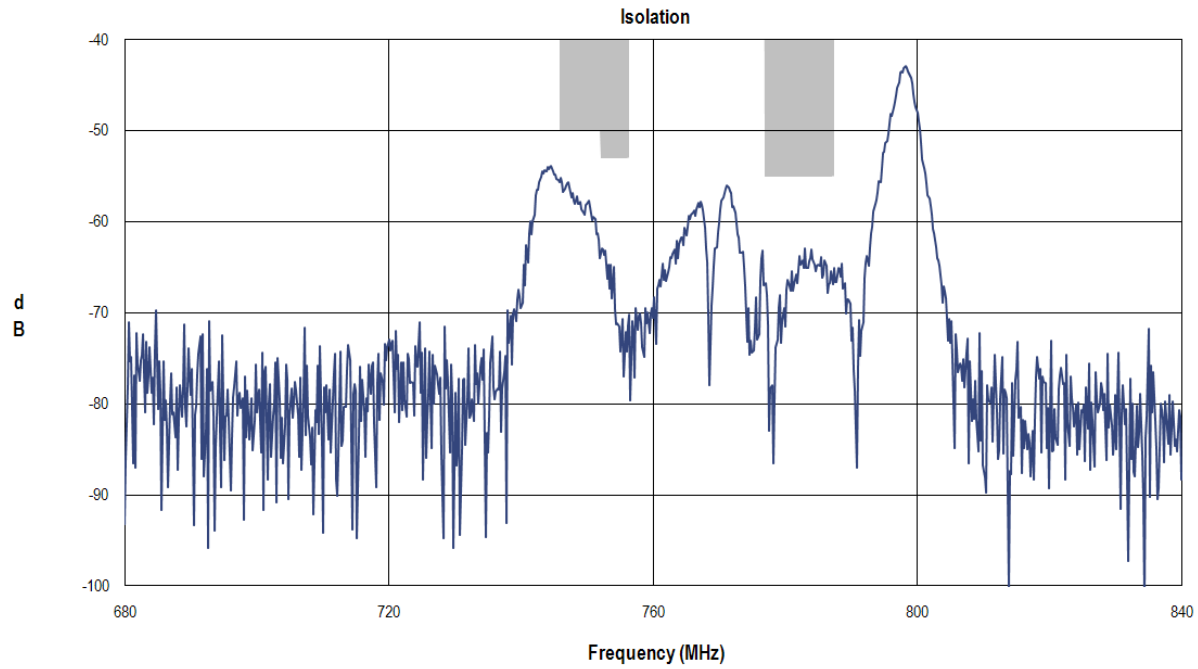

Reference Design – Ant - 50 SE In, Tx - 50 SE Out , Rx - 100 Bal Out

Schematic

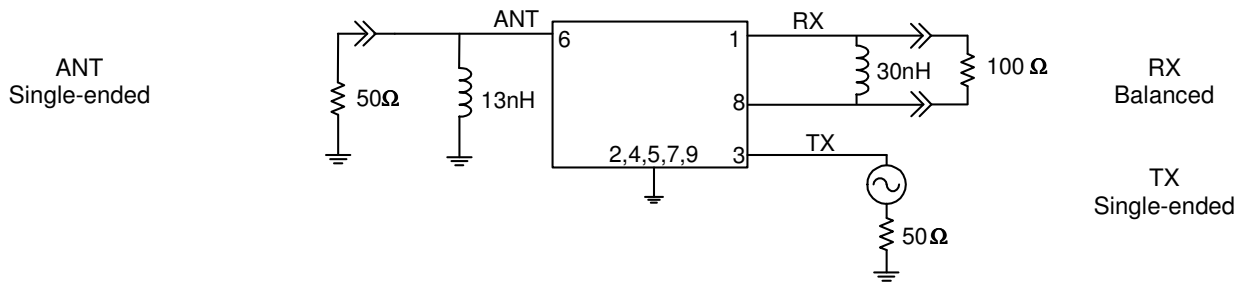

Notes:

1. Actual matching values may vary due to PCB layout and parasitic
2. If the DC level on any RF port is greater than 3V, it is recommended to add external DC block as needed. If not, no additional external components are required

PC Board

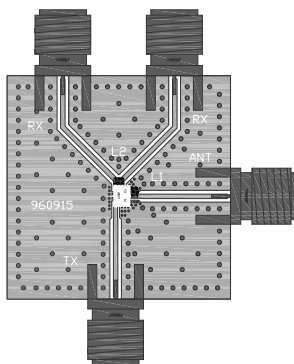

Notes:

- 3-layer board - top, middle & bottom layer: 1 oz copper
- Substrates: .031" thick FR4 dielectric.
- Finish plating: Nickel: 3-8μm thick, Gold: .03-.2μm thick
- Hole plating: Copper min .0008μm thick

Mounting Configuration

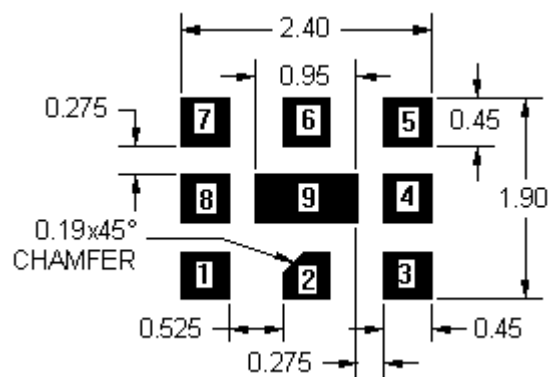

Notes:

1. Top view of the duplexer.
2. All dimensions are in millimeters.
3. This footprint represents a recommendation only.

Absolute Maximum Ratings

Parameter	Rating*
Operating Temperature	-30 to +90 °C
Storage Temperature	-30 to +90 °C

* Operation of this device outside the parameter ranges given above may cause permanent damage.

Bill of Material

Reference Desg.	Value	Description	Manufacturer	Part Number
L1_Ant	13 nH	Coil Wire-wound, 0603, y%	MuRata	LQW15AN13NH00
L2_Rx	30 nH	Coil Wire-wound, 0603, y%	MuRata	LQW15AN30NG00
SMA	N/A	SMA connector	Radiall USA Inc.	9602-1111-018
PCB	N/A	3-layer	Multiple	

856879

782/751 MHz Duplexer

Mechanical Information

Package Information, Dimensions and Marking

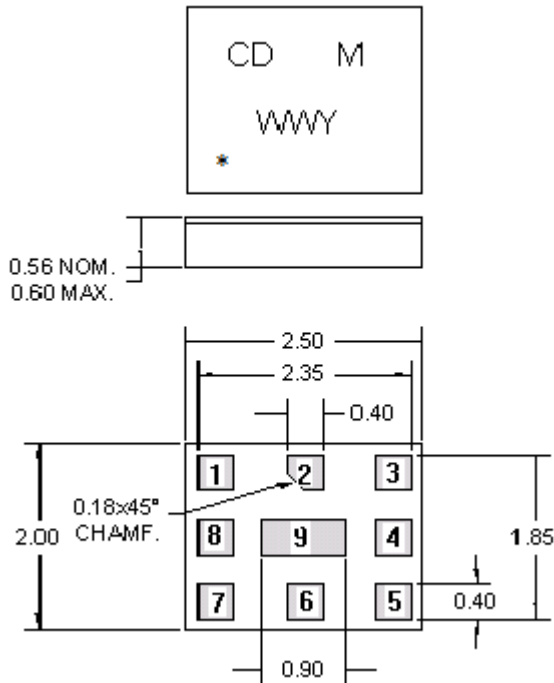

Package Style: CSP-10KT
Dimensions: 2.5 x 2.00 x 0.56 mm

Body: Al_2O_3 ceramic
Lid: Kovar or Alloy 42, Au over Ni plated
Terminations: Au plating 0.5 - 1.0 μ m, over a 2-6 μ m Ni plating

All dimensions shown are nominal in millimeters
All tolerances are ± 0.15 mm except overall length and width ± 0.10 mm

The date code consists of:
WW = 2 digit week,
Y = last digit of year,
M = manufacturing site code

Tape and Reel Information

Standard T/R size = 1,000 units/reel. All dimensions are in millimeters

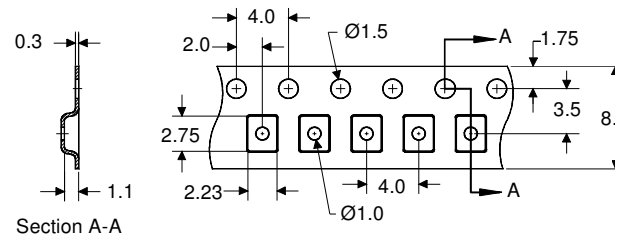
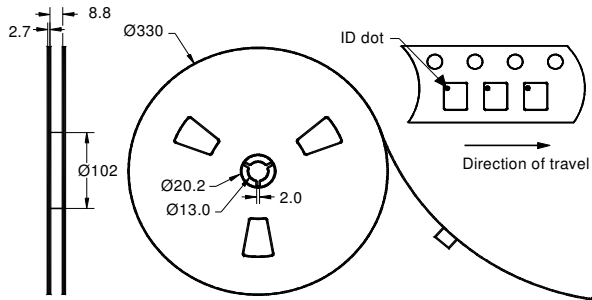

Product Compliance Information

ESD Information



Caution! ESD-Sensitive Device

ESD Rating: Class 0

Value: Passes $\leq 150V$ min.

Test: Human Body Model (HBM)

Standard: JEDEC Standard JESD22-A114

ESD Rating: Class A

Value: Passes $\leq 150V$ min.

Test: Machine Model (MM)

Standard: JEDEC Standard JESD22-A115

MSL Rating

Devices are Hermetic, therefore MSL is not applicable

Solderability

Compatible with the latest version of J-STD-020, lead free solder, 260°C

Refer to **Soldering Profile** for recommended guidelines.

This part is compliant with EU 2002/95/EC RoHS directive (Restrictions on the Use of Certain Hazardous Substances in Electrical and Electronic Equipment).

This product also has the following attributes:

- Halogen Free (Chlorine, Bromine)
- Antimony Free
- TBBP-A (C₁₅H₁₂Br₄O₂) Free
- PFOS Free
- SVHC Free

Contact Information

For the latest specifications, additional product information, worldwide sales and distribution locations, and information about TriQuint:

Web: www.triquint.com
Email: info-sales@tqs.com

Tel: +1.407.886.8860
Fax: +1.407.886.7061

Important Notice

The information contained herein is believed to be reliable. TriQuint makes no warranties regarding the information contained herein. TriQuint assumes no responsibility or liability whatsoever for any of the information contained herein. TriQuint assumes no responsibility or liability whatsoever for the use of the information contained herein. The information contained herein is provided "AS IS, WHERE IS" and with all faults, and the entire risk associated with such information is entirely with the user. All information contained herein is subject to change without notice. Customers should obtain and verify the latest relevant information before placing orders for TriQuint products. The information contained herein or any use of such information does not grant, explicitly or implicitly, to any party any patent rights, licenses, or any other intellectual property rights, whether with regard to such information itself or anything described by such information.

TriQuint products are not warranted or authorized for use as critical components in medical, life-saving, or life-sustaining applications, or other applications where a failure would reasonably be expected to cause severe personal injury or death.