

# 20.0-38.0 GHz GaAs MMIC Low Noise Amplifier, 3x3mm QFN



February 2008 - Rev 21-Feb-08

XL1010-QT  
RoHS

## Features

- ✕ 17.0 dB Small Signal Gain
- ✕ 3.0 dB Noise Figure
- ✕ Single, Positive Bias Supply
- ✕ 3x3mm QFN Package
- ✕ 100% RF Tested



## General Description

Mimix Broadband's three stage 20.0-38.0 GHz GaAs MMIC low noise amplifier has a small signal gain of 17.0 dB with a noise figure of 3.0 dB. The device comes in a RoHS compliant, 3x3mm QFN package and requires only a single positive bias supply. The device uses Mimix Broadband's 0.15  $\mu\text{m}$  GaAs PHEMT device model technology, and is based upon electron beam lithography to ensure high repeatability and uniformity. The device is well suited to multiple receiver applications which require broadband performance with simple bias requirements and the ease of volume manufacturing with 3x3mm QFN packaging.

## Absolute Maximum Ratings

Supply Voltage (Vd)	+7.0 VDC
Supply Current (Id1,2,3)	70 mA
Input Power (Pin)	+12.0 dBm
Storage Temperature (Tstg)	-65 to +165 °C
Operating Temperature (Ta)	-55 to MTTF Graph <sup>1</sup>
Channel Temperature (Tch)	MTTF Graph <sup>1</sup>

(1) Channel temperature affects a device's MTTF. It is recommended to keep channel temperature as low as possible for maximum life.

## Electrical Characteristics (Ambient Temperature T = 25 °C)

Parameter	Units	Min.	Typ.	Max.
Frequency Range (f)	GHz	20.0	-	38.0
Input Return Loss (S11)	dB	-	12.0	-
Output Return Loss (S22)	dB	-	15.0	-
Small Signal Gain (S21)	dB	-	17.0	-
Gain Flatness ( $\Delta S21$ )	dB	-	+/-2.0	-
Reverse Isolation (S12)	dB	-	45.0	-
Noise Figure (NF)	dB	-	3.0	-
Output Power for 1dB Compression (P1dB)	dBm	-	TBD	-
Drain Bias Voltage (Vd)	VDC	3.0	4.0	5.0
Supply Current (Id)	mA	-	45	60

# 20.0-38.0 GHz GaAs MMIC Low Noise Amplifier, 3x3mm QFN



February 2008 - Rev 21-Feb-08

LI1010-QT  
RoHS

## Low Noise Amplifier Measurements

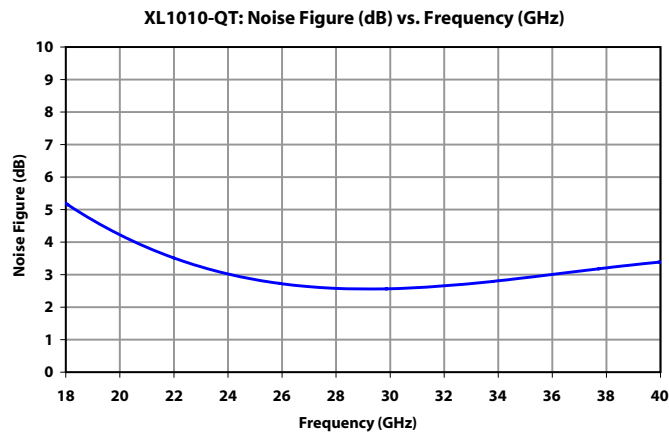
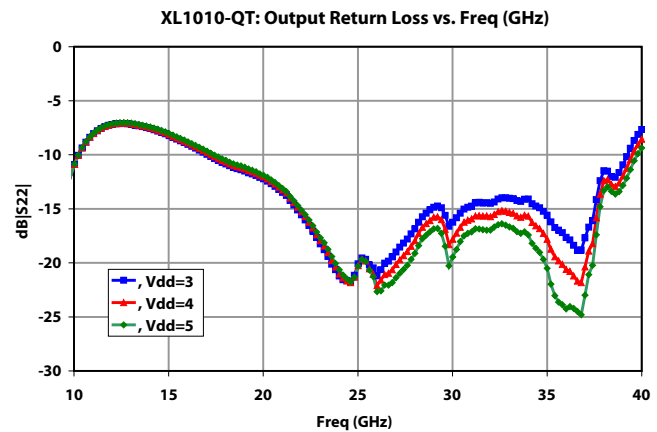
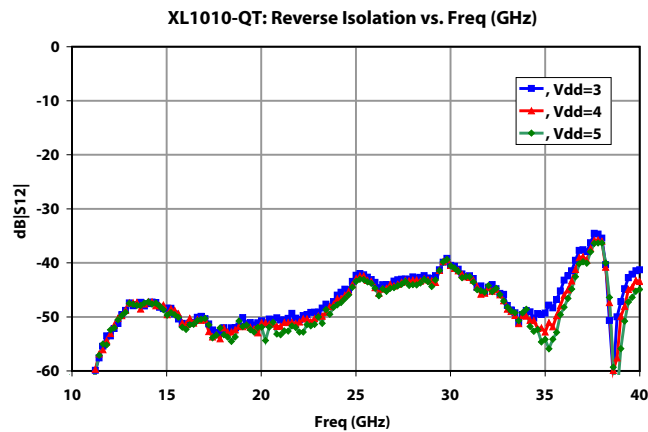
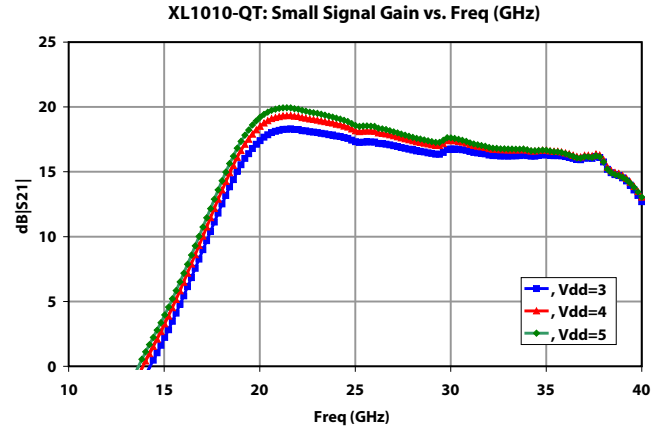
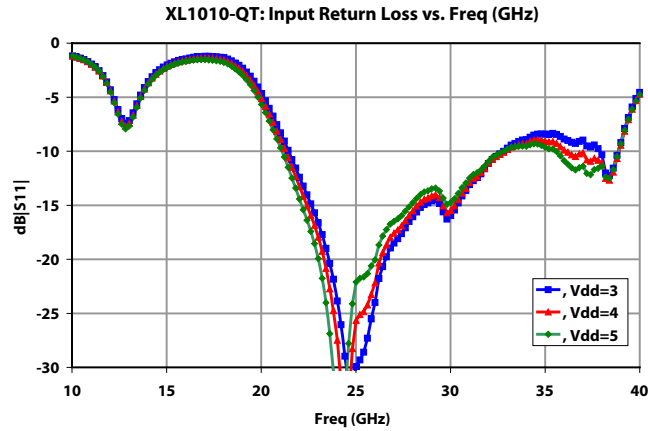

# 20.0-38.0 GHz GaAs MMIC Low Noise Amplifier, 3x3mm QFN

February 2008 - Rev 21-Feb-08

## Package Dimensions/Layout

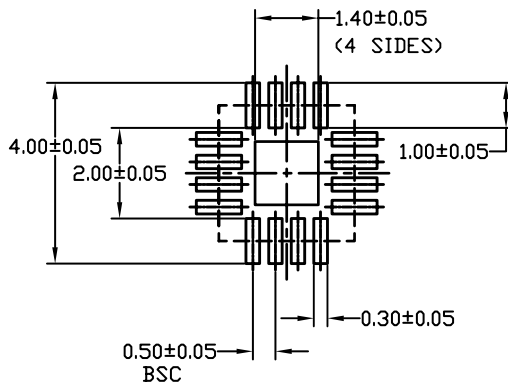
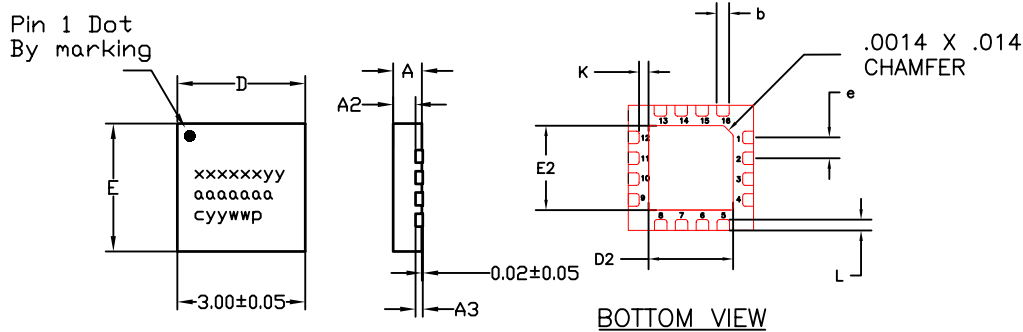

	MIN	TYP	MAX
A	0.80	0.90	1.00
A3	0.20 REF		
A2	0.00	0.65	1.00
b	0.20	0.25	0.30
K	0.20	-	-
D	3.00 BSC		
E	3.00 BSC		
e	0.50		
D2	1.50	1.65	1.80
E2	1.50	1.65	1.80
L	0.16	0.26	0.36

## Functional Block Diagram/Board Layout

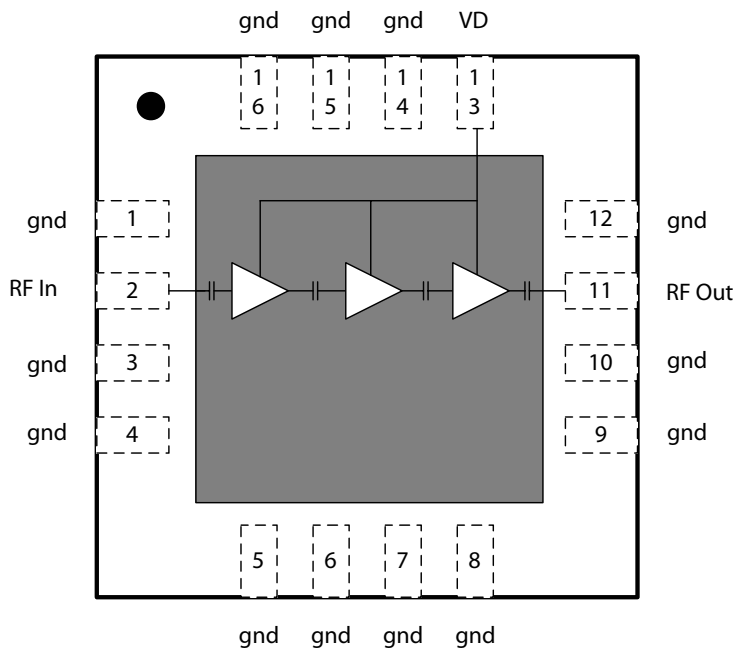

## Pin Designations

Pin Number	Pin Name	Pin Function	Nominal Value
1	GND	Ground	
2	RF In	RF Input	
3-10	GND	Ground	
11	RF Out	RF Output	
12	GND	Ground	
13	VD	Drain Bias	4V, 45 mA
14-16	GND	Ground	

# 20.0-38.0 GHz GaAs MMIC Low Noise Amplifier, 3x3mm QFN

February 2008 - Rev 21-Feb-08

**App Note [1] Biasing** - The device is operated with a single, positive bias supply. The device performance is insensitive to changes in bias condition; however, gain and power handling can be slightly improved with higher bias conditions without significantly affecting the noise figure performance. Typical biasing conditions within the specified performance ranges are  $V_d=3V, 35mA$ ,  $V_d=4V, 45mA$ ,  $V_d=5V, 55mA$ .

## PCB Board Layout

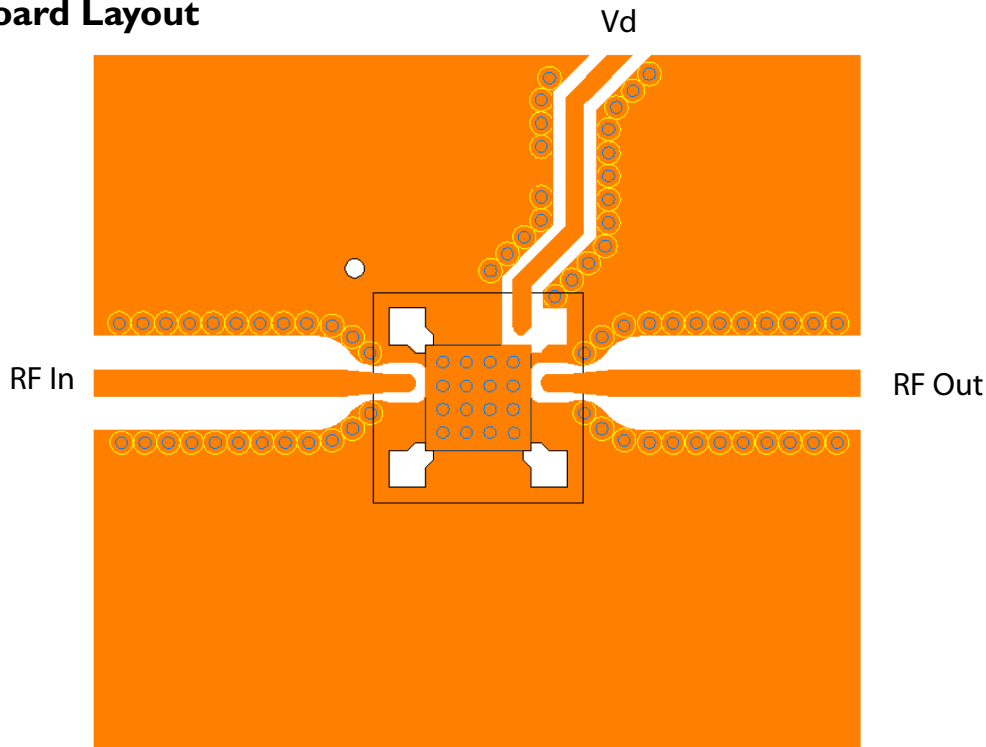

## MTTF Tables (TBD)

These numbers were calculated based on accelerated life test information and thermal model analysis received from the fabricating foundry.

Backplate Temperature	Channel Temperature	Rth	MTTF Hours	FITs
55 deg Celsius	Deg Celsius	C/W	E+	E+
75 deg Celsius	Deg Celsius	C/W	E+	E+
95 deg Celsius	Deg Celsius	C/W	E+	E+

**Bias Conditions:**  $V_d=3V, 35mA$ ,  $V_d=4V, 45mA$ ,  $V_d=5V, 55mA$

# 20.0-38.0 GHz GaAs MMIC Low Noise Amplifier, 3x3mm QFN

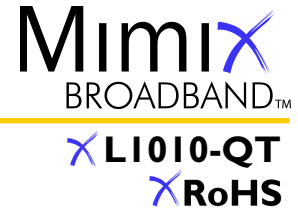

February 2008 - Rev 21-Feb-08

## Handling and Assembly Information

**CAUTION!** - Mimix Broadband MMIC Products contain gallium arsenide (GaAs) which can be hazardous to the human body and the environment. For safety, observe the following procedures:

- Do not ingest.
- Do not alter the form of this product into a gas, powder, or liquid through burning, crushing, or chemical processing as these by-products are dangerous to the human body if inhaled, ingested, or swallowed.
- Observe government laws and company regulations when discarding this product. This product must be discarded in accordance with methods specified by applicable hazardous waste procedures.

**Life Support Policy** - Mimix Broadband's products are not authorized for use as critical components in life support devices or systems without the express written approval of the President and General Counsel of Mimix Broadband. As used herein: (1) Life support devices or systems are devices or systems which, (a) are intended for surgical implant into the body, or (b) support or sustain life, and whose failure to perform when properly used in accordance with instructions for use provided in the labeling, can be reasonably expected to result in a significant injury to the user. (2) A critical component is any component of a life support device or system whose failure to perform can be reasonably expected to cause the failure of the life support device or system, or to affect its safety or effectiveness.

**Package Attachment** - This packaged product from Mimix Broadband is provided as a rugged surface mount package compatible with high volume solder installation. Vacuum tools or other suitable pick and place equipment may be used to pick and place this part. Care should be taken to ensure that there are no voids or gaps in the solder connection so that good RF, DC and ground connections are maintained. Voids or gaps can eventually lead not only to RF performance degradation, but reduced reliability and life of the product due to thermal stress.

### Typical Reflow Profiles

Reflow Profile	SnPb	Pb Free
Ramp Up Rate	3-4 °C/sec	3-4 °C/sec
Activation Time and Temperature	60-120 sec @ 140-160 °C	60-180 sec @ 170-200 °C
Time Above Melting Point	60-150 sec	60-150 sec
Max Peak Temperature	240 °C	265 °C
Time Within 5 °C of Peak	10-20 sec	10-20 sec
Ramp Down Rate	4-6 °C/sec	4-6 °C/sec

### Factory Automation and Identification

Mimix Designator	Package Type	Number of leads offered	W Tape Width	P <sub>1</sub> Component Pitch	P <sub>0</sub> Hole Pitch	Reel Diameter	Units per Reel
-QT	QFN (3x3mm)	16	12mm	8mm	4mm	329mm (13in)	2000

Component Orientation: Parts are to be oriented with the PIN 1 closest to the tape's round sprocket holes on the tape's trailing edge.

Note: Tape and Reel packaging is ordered with a -000T suffix. Package is available in 500 unit reels through designated sales channels. Minimum order quantities should be discussed with your local sales representative.

**Mimix Lead-Free RoHS Compliant Program** - Mimix has an active program in place to meet customer and governmental requirements for eliminating lead (Pb) and other environmentally hazardous materials from our products. All Mimix RoHS compliant components are form, fit and functional replacements for their non-RoHS equivalents. Lead plating of our RoHS compliant parts is 100% matte tin (Sn) over copper alloy and is backwards compatible with current standard SnPb low-temperature reflow processes as well as higher temperature (260°C reflow) "Pb Free" processes.

## Ordering Information

### Part Number for Ordering

XL1010-QT-0G00  
XL1010-QT-0G0T  
XL1010-QT-EV1

### Description

Matte Tin plated RoHS compliant 3x3 16L QFN surface mount package in bulk quantity  
Matte Tin plated RoHS compliant 3x3 16L QFN surface mount package in tape and reel  
XL1010-QT evaluation board



Proper ESD procedures should be followed when handling this device.

Mimix Broadband, Inc., 10795 Rockley Rd., Houston, Texas 77099  
Tel: 281.988.4600 Fax: 281.988.4615 mimixbroadband.com

Page 5 of 5

Characteristic Data and Specifications are subject to change without notice. ©2008 Mimix Broadband, Inc.  
Export of this item may require appropriate export licensing from the U.S. Government. In purchasing these parts, U.S. Domestic customers accept their obligation to be compliant with U.S. Export Laws.