

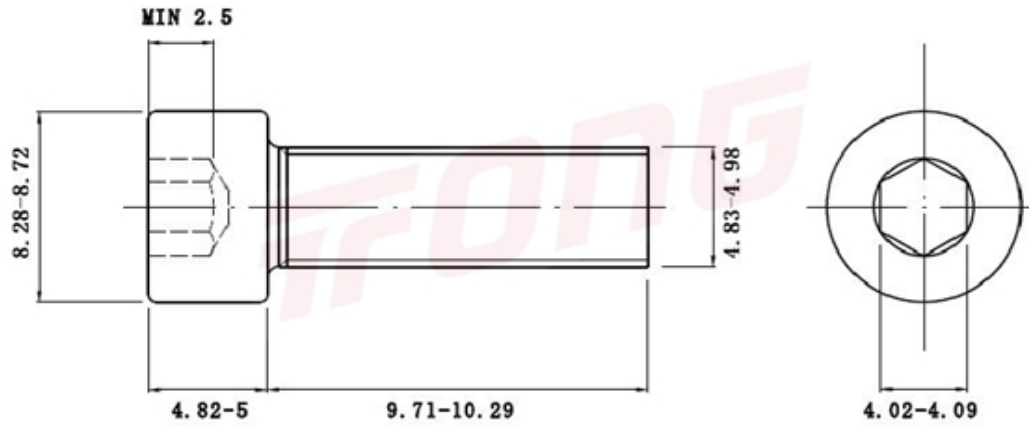

项目号 384



*图纸仅供参考，请以实物为准

材质	304
标准	DIN912
规格	M5-0.8 X 10
项目号	384
品名	内六角螺丝(滚花)



项目号 384

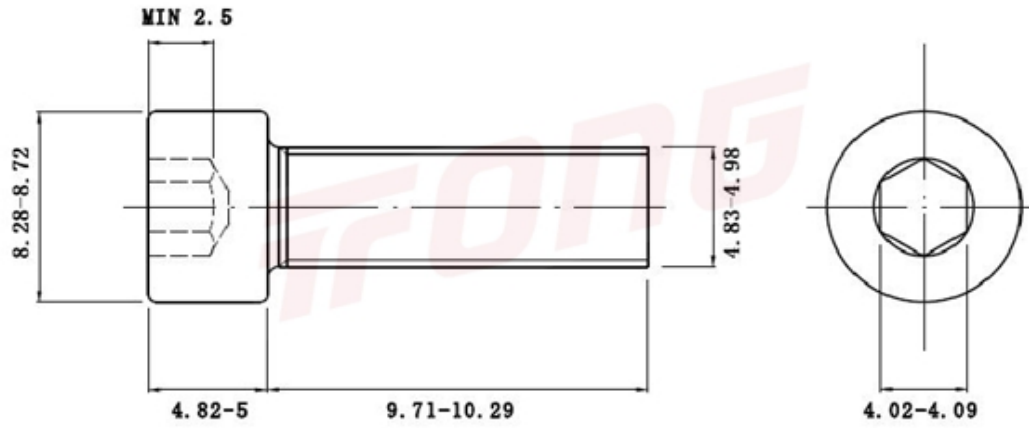

*图纸仅供参考，请以实物为准

材质	304
标准	DIN912
规格	M5-0.8 X 10
项目号	384
品名	内六角螺丝(滚花)