

SENSITIVE SCRs

DESCRIPTION

The X0202/A SCR series is suitable for all applications where the available gate current is limited, such as ground fault circuit interruptors, overvoltage crowbar protection in low power supplies, capacitive ignition circuit,.....

FEATURES:

- * $I_{T(RMS)}$: 1.25A
- * V_{DRM}/V_{RRM} : 600/800V

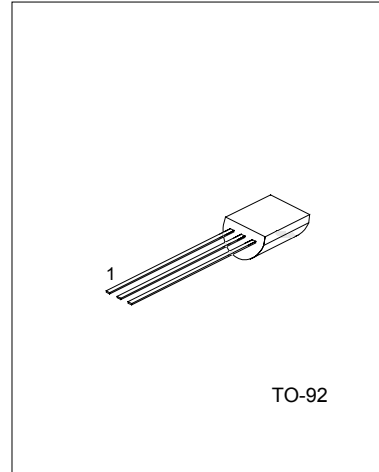

1:CATHODE 2:GATE 3:ANODE

ABSOLUTE MAXIMUM RATINGS (unless otherwise specified)

PARAMETERS	SYMBOL	RATINGS	UNIT
Peak Repetitive Forward and Reverse Blocking Voltage ($T_j=110^{\circ}C$, $R_{GK}=1k\Omega$)	V_{DRM} , V_{RRM}	600	V
X0202 X0202A		800	
RMS On-State Current 180°C conduction angle ($T_I=55^{\circ}C$)	$I_{T(RMS)}$	1.25	A
Average On-State Current 180°C conduction angle ($T_I=55^{\circ}C$)	$I_{T(AV)}$	0.8	A
Non Repetitive Surge Peak on-state Current ($t_p=8.3ms$ $T_j=25^{\circ}C$)	I_{TSM}	25	A
Non Repetitive Surge Peak on-state Current ($t_p=10ms$ $T_j=25^{\circ}C$)	I_{TSM}	22.5	A
I t Value for fusing ($t_p=10ms$ $T_j=25^{\circ}C$)	I t	2.5	A ² S
Critical Rate Of Rise Of On-state Current $I_G=2*I_{GT}$, $t_r \leq 100ns$, $f=60Hz$, $T_j=125^{\circ}C$	dI/dt	50	A/ μs
Peak Gate Current ($p=20\mu s$ $T_j=125^{\circ}C$)	I_{GM}	1.2	A
Average Gate Power Dissipation ($T_j=125^{\circ}C$)	$P_{G(AV)}$	0.2	W
Storage Junction Temperature Range	T_{stg}	-40~150	°C
Operating Junction Temperature Range	T_j	-40~125	°C

ELECTRICAL CHARACTERISTICS (T_j=25°C, unless otherwise specified)

PARAMETER	SYMBOL	TEST CONDITIONS	MIN	TYP	MAX	UNIT
Peak Forward or Reverse Blocking Current T _j =25°C T _j =125°C	I _{DRM} , I _{RRM}	V _{DRM} =V _{RRM} , R _{GK} =1k Ω			5 500	μ A μ A
Peak Forward On-State Voltage	V _{TM}	I _{TM} = 2.5A, t _p =380μs			1.45	V
Gate Trigger Current	I _{GT}	V _D =12V, R _L =140 Ω			200	μ A
Gate Trigger Voltage	V _{GT}	V _D =12V, R _L =140 Ω			0.8	V
Gate Non-Trigger Voltage	V _{GD}	V _D =V _{DRM} , R _L =3.3k Ω, R _{GK} =1k Ω, (T _j =125°C)	0.1			V
Holding Current	I _H	I _T =50mA, R _{GK} =1k Ω			5	mA
Latch Current	I _L	I _G =1mA, R _{GK} =1k Ω			6	mA
Critical Rate of Rise of Off-State Voltage	dv/dt	V _D =67%V _{DRM} , R _{GK} =1k Ω, (T _j =110°C)	10			V/μs
Peak Reversed Gate Voltage	V _{RG}	I _{RG} =10μ A	8			V
Threshold Voltage	V _{TO}	(T _j =125°C)			0.9	V
Dynamic Resistance	R _d	(T _j =125°C)			200	m Ω

THERMAL CHARACTERISTICS

SYMBOL	PARAMETER	VALUE	UNIT
R _{th(j-l)}	Junction to leads	60	°C/W
R _{th(j-a)}	Junction to ambient	150	°C/W

TYPICAL CHARACTERISTICS CURVE

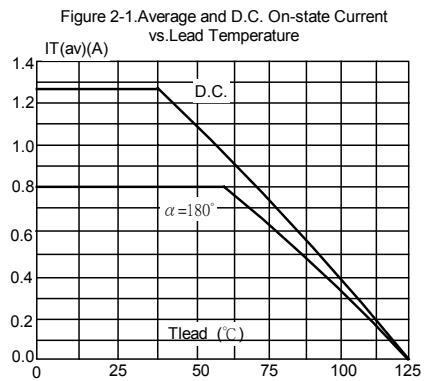
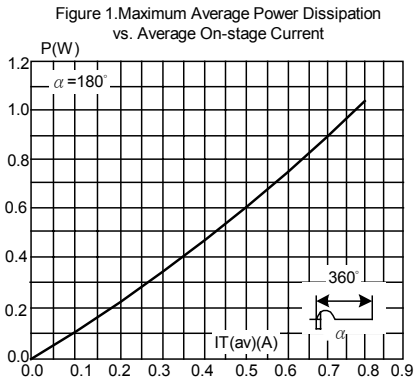

Figure 2-2. Average and D.C. On-state Current vs. Ambient Temperature (Device Mounted On FR4 with Recommended Pad Layout)

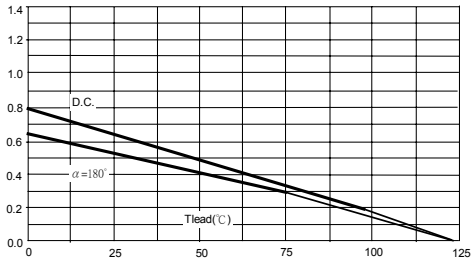

Figure 3. Relative Variation of Thermal Impedance Junction to Ambient vs. Pulse Duration

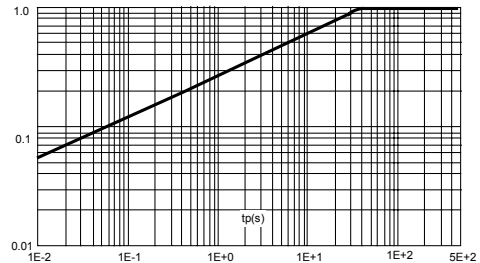

Figure 4. Relative Variation of Gate Trigger Current, Holding Current and Latching Current Versus Junction Temperature (typical values).

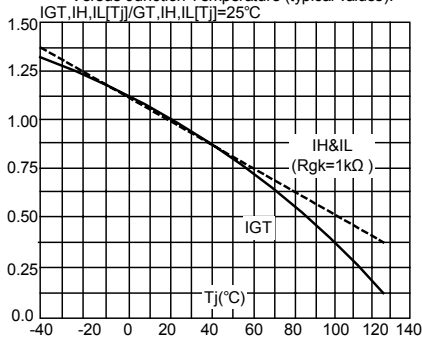

Figure 5. Relative Variation of Holding Current vs. Gate-cathode Resistance (typical values).

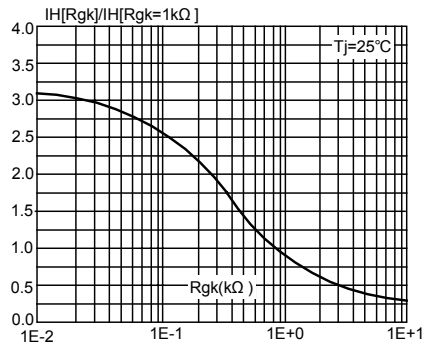

Figure 6. Relative Variation of dV/dt immunity vs. Gate-Cathode Resistance (typical values).

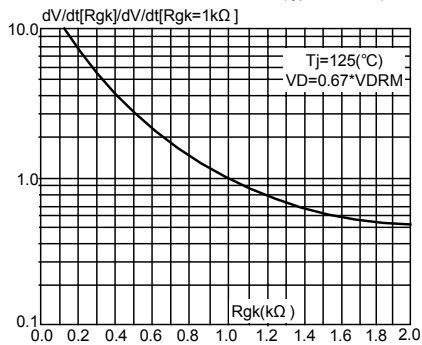

Figure 7. Relative Variation of dV/dt Immunity vs. Gate-cathode Capacitance (typical values).

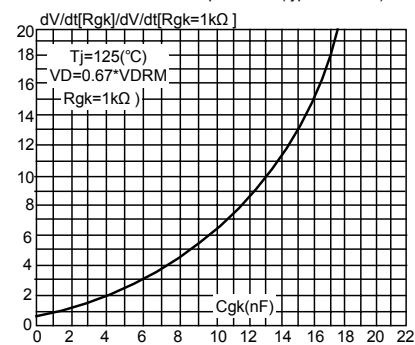

Figure 8. Surge Peak On-state Current vs. Number of Cycles.

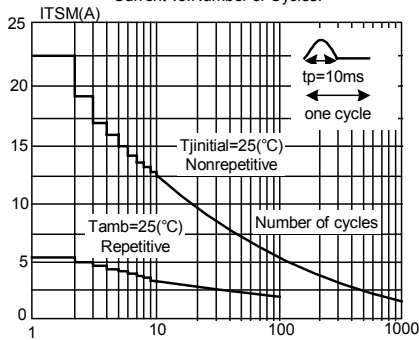

Figure 9. Non-repetitive Surge Peak on-state Current for a Sinusoidal pulse with width $t_p < 10\text{ms}$, and Corresponding Value of I^2t

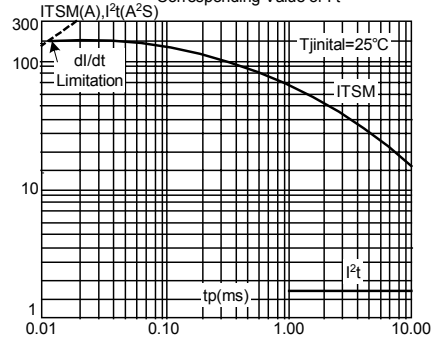
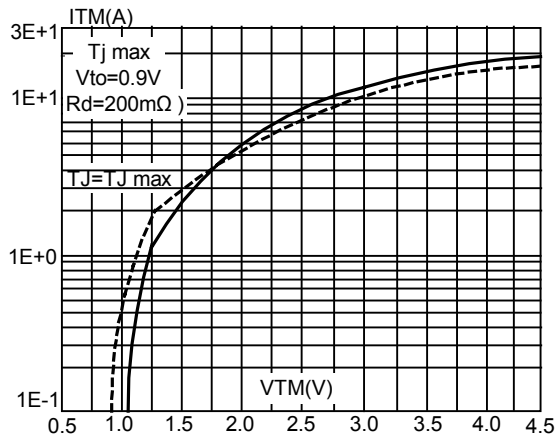

Figure 10. On-state Characteristics (maximum values)



UTC assumes no responsibility for equipment failures that result from using products at values that exceed, even momentarily, rated values (such as maximum ratings, operating condition ranges, or other parameters) listed in products specifications of any and all UTC products described or contained herein. UTC products are not designed for use in life support appliances, devices or systems where malfunction of these products can be reasonably expected to result in personal injury. Reproduction in whole or in part is prohibited without the prior written consent of the copyright owner. The information presented in this document does not form part of any quotation or contract, is believed to be accurate and reliable and may be changed without notice.