

# Ceramic Balun RF Transformer

50Ω 700 to 2700 MHz 1:1 Ratio

## TCW1-2700+



Generic photo used for illustration purposes only

CASE STYLE: JC0603C

**+RoHS Compliant**

The +Suffix identifies RoHS Compliance. See our web site for RoHS Compliance methodologies and qualifications



Available Tape and Reel  
at no extra cost

Reel Size	Devices/Reel
7"	20, 50, 100, 200, 500, 1000, 4000

### Features

- wideband, 700 to 2700 MHz
- miniature size 0603 (1.6x0.8mm)
- LTCC construction
- low cost
- aqueous washable

### Applications

- WLAN
- A/D conversion
- WiFi
- transmitters and receivers
- cellular

### Electrical Specifications at 25°C

Parameter	Frequency (MHz)	Min.	Typ.	Max.	Unit
Impedance Ratio			1		
Frequency Range		700		2700	MHz
Insertion Loss <sup>1</sup>	700 - 2700		1.4	2.0	dB
Amplitude Unbalance	700 - 2700		1	2	dB
Phase Unbalance <sup>2</sup>	700 - 2700		12	15	Degree

1. Reference Demo Board TB-912+
2. Relative to 180°

### Maximum Ratings

Parameter	Ratings
Operating Temperature	-55°C to 100°C
Storage Temperature	-55°C to 100°C
RF Power	0.5W

Permanent damage may occur if any of these limits are exceeded.

### Pad Connections

Function	Pin Number
PRIMARY DOT	1
GND or DC feed + RF	2
SECONDARY DOT	3
SECONDARY	4
NO CONNECTION	6
GND	5

### Configuration R

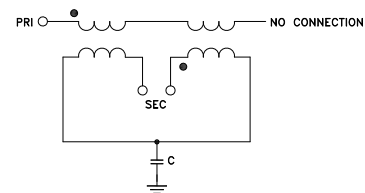

# TCW1-2700+

## Outline Drawing

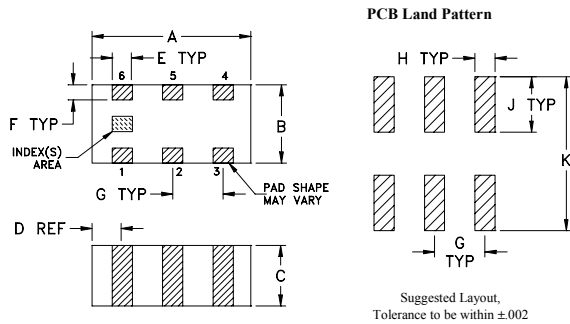

## Outline Dimensions (inch/mm)

A	B	C	D	E	F	
.063	.031	.024	.012	.008	.006	
1.60	0.79	0.61	0.30	0.20	0.15	
G	H	J	K		wt	
.020	.010	.022	.053		grams	
0.51	0.25	0.56	1.35		0.005	

## Demo Board MCL P/N: TB-912+ Suggested PCB Layout (PL-574)

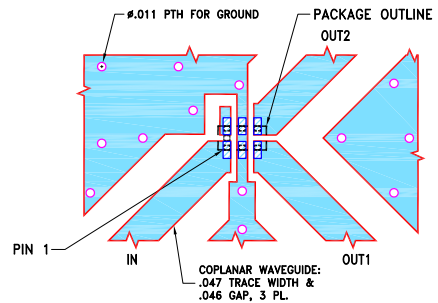

### NOTES:

- TRACE WIDTH & GAP PARAMETERS ARE SHOWN FOR ROGERS RO4350B WITH DIELECTRIC THICKNESS .020±.0015. COPPER: 1/2 OZ. EACH SIDE. FOR OTHER MATERIALS TRACE WIDTH & GAP MAY NEED TO BE MODIFIED.
- BOTTOM SIDE OF THE PCB IS CONTINUOUS GROUND PLANE.

- DENOTES PCB COPPER LAYOUT WITH SMOBC (SOLDER MASK OVER BARE COPPER).
- DENOTES COPPER LAND PATTERN FREE OF SOLDER MASK.

## Typical Performance Data<sup>3</sup>

Frequency (MHz)	Insertion Loss (dB)	Input R. Loss (dB)	Amplitude Unbalance (dB)	Phase Unbalance (Deg.)
700.0	4.18	12.59	0.82	5.51
800.0	4.06	15.22	0.77	5.31
1000.0	3.97	19.14	0.62	4.81
1200.0	4.02	16.74	0.43	4.02
1400.0	4.14	13.18	0.23	2.95
1600.0	4.30	10.79	0.07	1.65
1800.0	4.45	9.44	0.04	0.14
2100.0	4.53	9.01	0.01	2.41
2400.0	4.40	10.75	0.37	5.22
2700.0	4.27	16.86	1.10	8.15

3. Measured with Agilent N5242A network analyzer using impedance conversion and port extension.

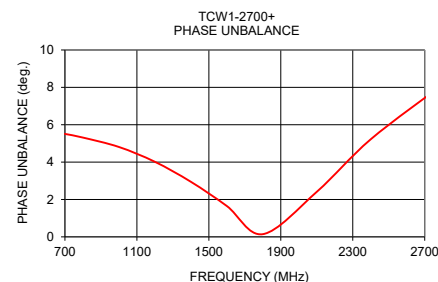
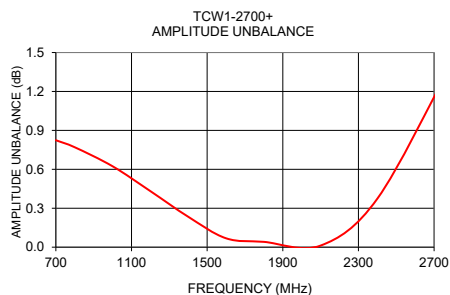
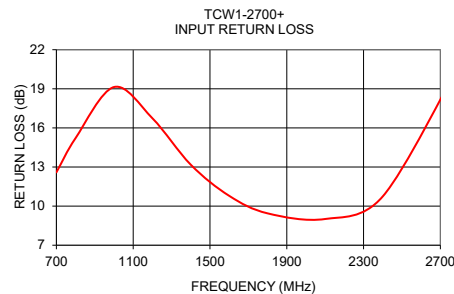
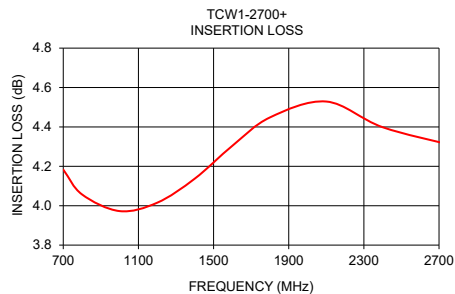

### Additional Notes

- Performance and quality attributes and conditions not expressly stated in this specification document are intended to be excluded and do not form a part of this specification document.
- Electrical specifications and performance data contained in this specification document are based on Mini-Circuits' applicable established test performance criteria and measurement instructions.
- The parts covered by this specification document are subject to Mini-Circuits standard limited warranty and terms and conditions (collectively, "Standard Terms"); Purchasers of this part are entitled to the rights and benefits contained therein. For a full statement of the Standard Terms and the exclusive rights and remedies thereunder, please visit Mini-Circuits' website at [www.minicircuits.com/MCLStore/terms.jsp](http://www.minicircuits.com/MCLStore/terms.jsp)



## Typical Performance Data

FREQUENCY (MHz)	AVERAGE INSERTION LOSS (dB)	INPUT RETURN LOSS (dB)	AMPLITUDE UNBALANCE (dB)	PHASE UNBALANCE (deg.)
500	1.90	7.41	0.86	5.76
550	1.62	8.70	0.86	5.70
600	1.42	9.97	0.85	5.63
650	1.29	11.29	0.85	5.57
700	1.18	12.59	0.82	5.51
750	1.11	13.93	0.80	5.44
800	1.06	15.22	0.77	5.31
850	1.02	16.48	0.74	5.22
900	0.99	17.68	0.70	5.09
950	0.98	18.62	0.66	4.99
1000	0.97	19.14	0.62	4.81
1050	0.97	19.04	0.57	4.65
1100	0.98	18.51	0.53	4.46
1150	0.99	17.69	0.48	4.23
1200	1.02	16.74	0.43	4.02
1250	1.04	15.76	0.38	3.77
1300	1.07	14.83	0.33	3.52
1350	1.10	13.95	0.29	3.25
1400	1.14	13.18	0.23	2.95
1450	1.18	12.46	0.19	2.64
1500	1.22	11.84	0.14	2.31
1550	1.26	11.27	0.10	2.00
1600	1.30	10.79	0.07	1.65
1650	1.34	10.37	0.03	1.27
1700	1.38	10.01	0.00	0.92
1750	1.42	9.69	0.02	0.53
1800	1.45	9.44	0.04	0.14
1850	1.48	9.24	0.04	0.27
1900	1.50	9.10	0.05	0.69
1950	1.52	9.01	0.05	1.10
2000	1.53	8.95	0.04	1.53
2050	1.53	8.98	0.02	1.96
2100	1.53	9.01	0.01	2.41
2150	1.52	9.16	0.05	2.87
2200	1.51	9.31	0.09	3.31
2250	1.48	9.58	0.15	3.79
2300	1.46	9.86	0.22	4.26
2350	1.43	10.27	0.29	4.76
2400	1.40	10.75	0.37	5.22
2450	1.37	11.34	0.47	5.72
2500	1.34	12.07	0.58	6.22
2550	1.31	12.91	0.70	6.68
2600	1.29	13.98	0.81	7.19
2650	1.28	15.20	0.96	7.67
2700	1.27	16.86	1.10	8.15
2750	1.28	18.66	1.26	8.61
2800	1.30	20.92	1.43	9.12
2850	1.33	22.76	1.61	9.59
2900	1.39	23.08	1.82	10.06
2950	1.45	21.50	2.01	10.54
3000	1.55	19.26	2.24	11.03

## Typical Performance Data

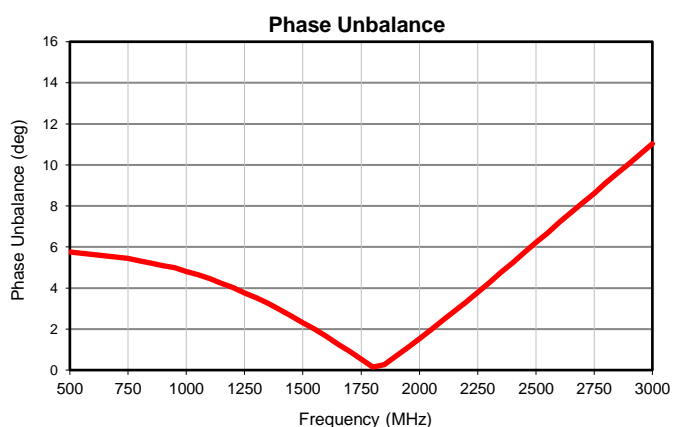
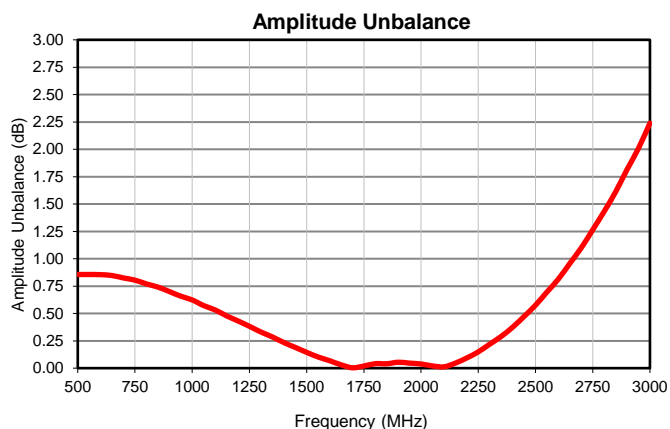
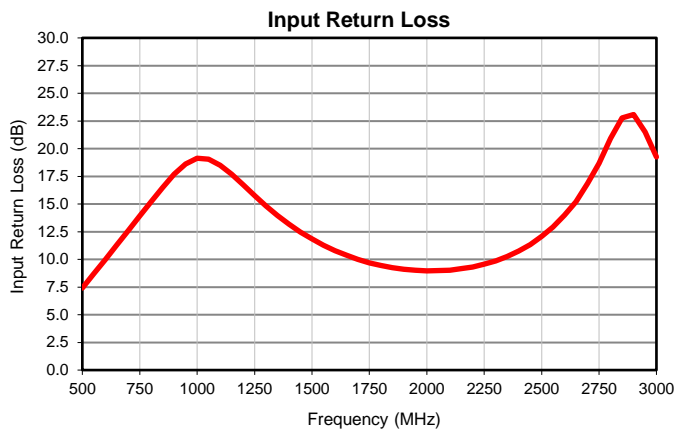
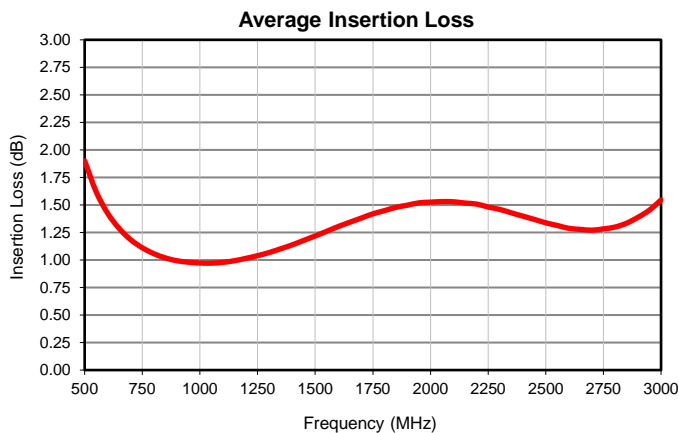

## Outline Dimensions

JC0603C

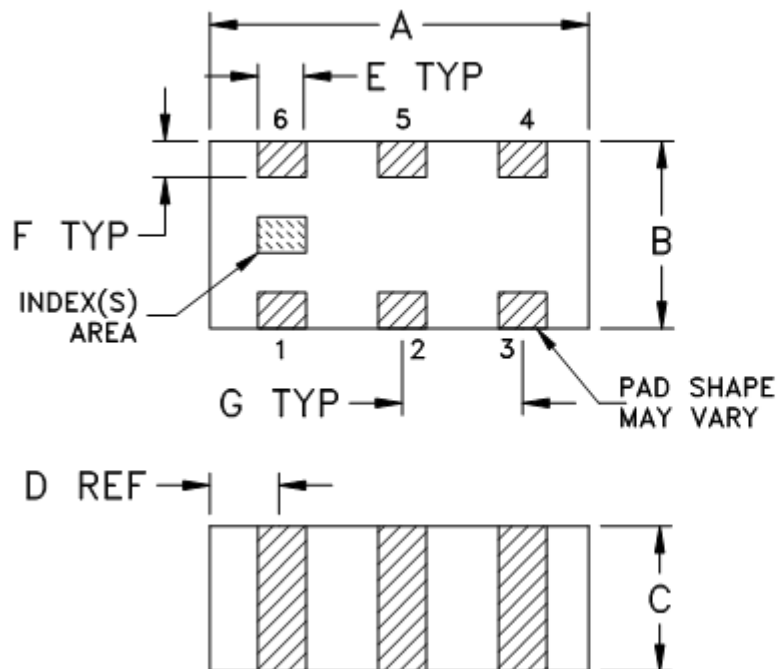

## PCB Land Pattern

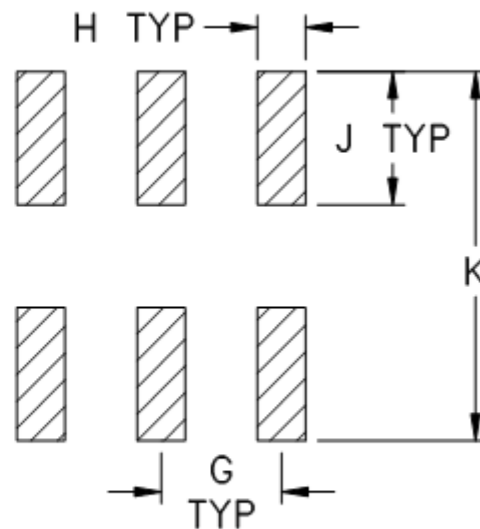

Suggested Layout,  
Tolerance to be within  $\pm .002$

CASE #	A	B	C	D	E	F	G	H	J	K	WT. GRAM
JC0603C	.063 (1.60)	.031 (0.80)	.024 (0.60)	.012 (0.30)	.008 (0.20)	.006 (0.15)	.020 (0.50)	.010 (0.25)	.022 (0.55)	0.053 (1.35)	.005

Dimensions are in inches (mm). Tolerances: 2 Pl.  $\pm .01$ ; 3 Pl.  $\pm .005$

### Notes:

1. Open style, ceramic base.
2. Termination finish:  
For RoHS Case Styles: Tin plate over Nickel plate. All models, (+) suffix.



P.O. Box 350166, Brooklyn, New York 11235-0003 (718) 934-4500 Fax (718) 332-4661 For detailed performance specs & shopping online see Mini-Circuits web site



The Design Engineers Search Engine Provides ACTUAL Data Instantly From MINI-CIRCUITS At: [www.minicircuits.com](http://www.minicircuits.com)

RF/IF MICROWAVE COMPONENTS

# Tape & Reel Packaging TR-F114

## DEVICE ORIENTATION IN T&R

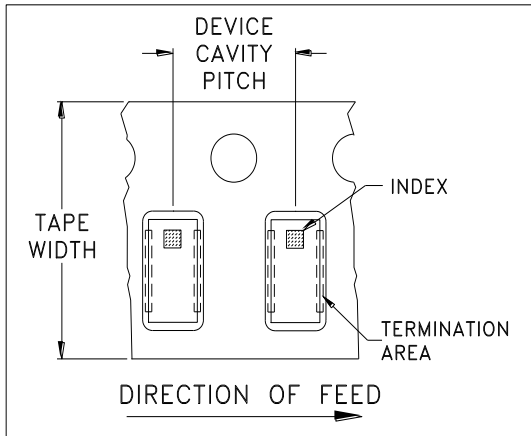

ILLUSTRATION 1

Applicable Case Styles	
GE0805C	JC0603C
GE0805C-1	JC0603C-4
GE0805C-1AP	JC0603C-6
GE0805C-7	
GE0805C-9	
GE0805C-10	
GE0805C-11	
GE0805C-12	

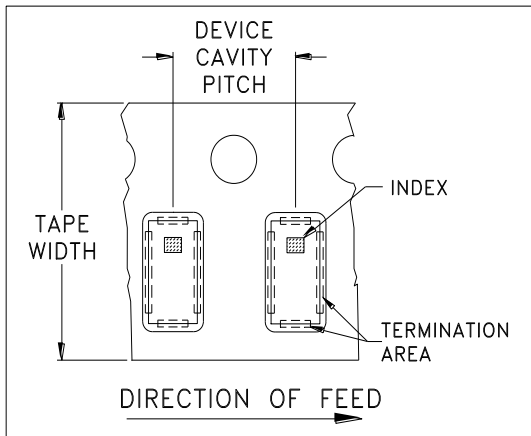

ILLUSTRATION 2

Applicable Case Styles	
GE0805C-2	JC0603C-1
GE0805C-3	JC0603C-2
GE0805C-4	JC0603C-3
GE0805C-5	JC0603C-5
GE0805C-6	JC0603C-7
GE0805C-8	JV1210C-1

Tape Width, mm	Device Cavity Pitch, mm	Reel Size, inches	Devices per Reel	
8	4	7	Small quantity standards (see note)	20
				50
				100
				200
				500
			Standard	1000
			Standard	4000

Note: Please Consult individual model data sheet to determine device per reel availability.

Mini-Circuits carrier tape materials provide protection from ESD (Electro-Static Discharge) during handling and transportation. Tapes are static dissipative and comply with industry standards EIA-481/EIA-541.

Go to: [www.minicircuits.com/pages/pdfs/tape.pdf](http://www.minicircuits.com/pages/pdfs/tape.pdf)



INTERNET <http://www.minicircuits.com>

P.O. Box 350166, Brooklyn, New York 11235-0003 (718) 934-4500 Fax (718) 332-4661

Distribution Centers NORTH AMERICA 800-654-7949 • 417-335-5935 • Fax 417-335-5945 • EUROPE 44-1252-832600 • Fax 44-1252-837010

Mini-Circuits ISO 9001 & ISO 14001 Certified

THIRD ANGLE PROJECTION

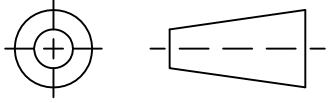

REVISIONS

REV	ECN No.	DESCRIPTION	DATE	DR	AUTH
OR	M166452	NEW RELEASE	02/22/18	ITG	BK

SUGGESTED MOUNTING CONFIGURATION  
FOR JC0603C CASE STYLE, "06TR01" PIN CODE

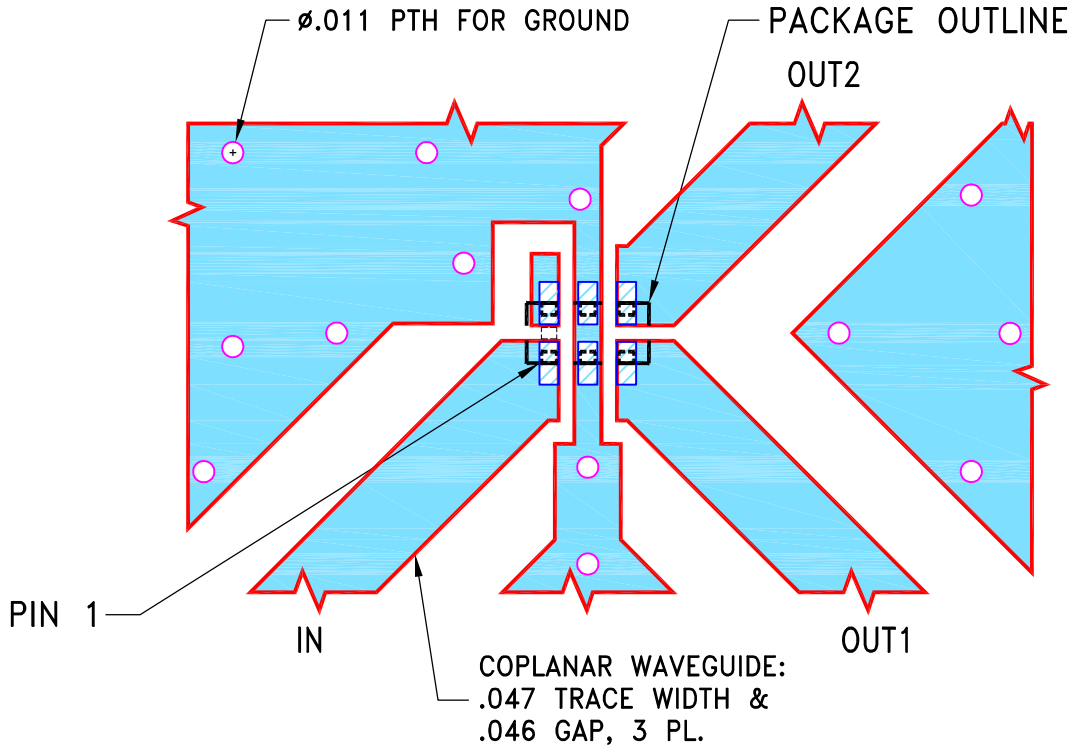

NOTES:

1. TRACE WIDTH & GAP PARAMETERS ARE SHOWN FOR ROGERS R04350B WITH DIELECTRIC THICKNESS  $.020 \pm .0015$ . COPPER: 1/2 OZ. EACH SIDE. FOR OTHER MATERIALS TRACE WIDTH & GAP MAY NEED TO BE MODIFIED.
2. BOTTOM SIDE OF THE PCB IS CONTINUOUS GROUND PLANE.

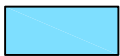

DENOTES PCB COPPER LAYOUT WITH SMOBC (SOLDER MASK OVER BARE COPPER).

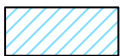

DENOTES COPPER LAND PATTERN FREE OF SOLDER MASK.

UNLESS OTHERWISE SPECIFIED	INITIALS	DATE
DIMENSIONS ARE IN INCHES	DRAWN ITG	02/20/18
TOLERANCES ON:	CHECKED GF	02/21/18
2 PL DECIMALS ±	APPROVED BK	02/22/18
3 PL DECIMALS ± .005		
ANGLES ±		
FRACTIONS ±		



**Mini-Circuits®**

13 Neptune Avenue  
 Brooklyn NY 11235

PL, 06TR01, JC0603C, TB-912+

Mini-Circuits®  
 THIS DOCUMENT AND ITS CONTENTS ARE THE PROPERTY OF MINI-CIRCUITS. EXCEPT FOR USE EXPRESSLY GRANTED, IN WRITING, TO ITS VENDORS, VENDEE AND THE UNITED STATES GOVERNMENT, MINI-CIRCUITS RESERVES ALL PROPRIETARY DESIGN, USE, MANUFACTURING AND REPRODUCTION RIGHTS THERETO. THESE CONTENTS SHALL NOT BE USED, DUPLICATED OR DISCLOSED TO ANY OUTSIDE PARTY, IN WHOLE OR IN PART, WITHOUT WRITTEN PERMISSION OF MINI-CIRCUITS.

SIZE	CODE IDENT	DRAWING NO:	REV:
A	15542	98-PL-574	OR
FILE:	98PL574	SCALE: 10:1	SHEET: 1 OF 1

# Evaluation Board and Circuit

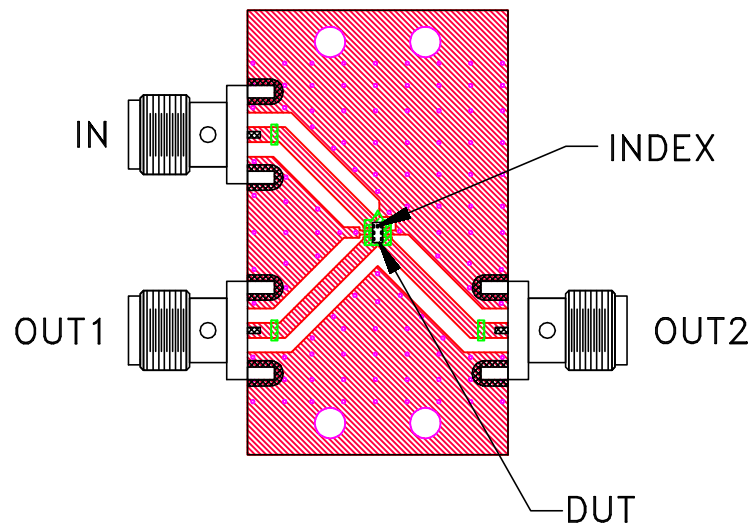

TB-912+

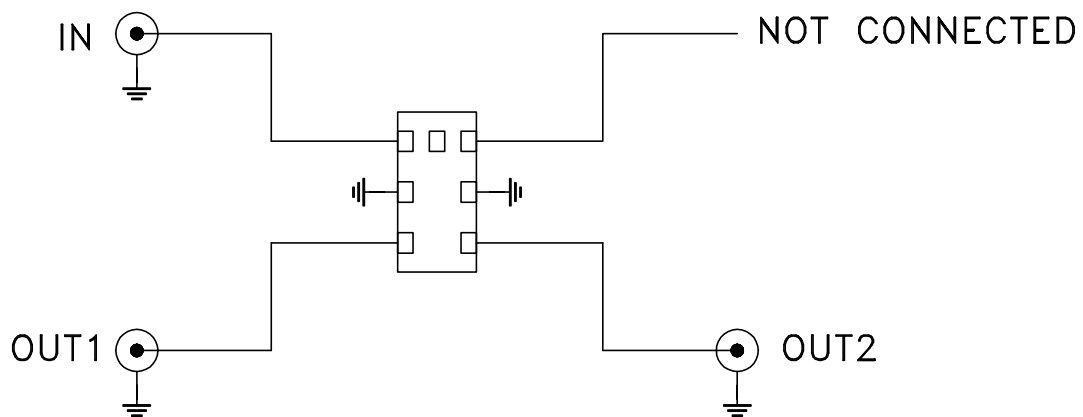

Schematic Diagram

## Notes:

1. 50 Ohm SMA Female connectors.
2. PCB Material: R04350 or equivalent,  
Dielectric Constant=3.5,  
Thickness=.020 inch.

 **Mini-Circuits®**



All Mini-Circuits products are manufactured under exacting quality assurance and control standards, and are capable of meeting published specifications after being subjected to any or all of the following physical and environmental test.

Specification	Test/Inspection Condition	Reference/Spec
Operating Temperature	-55° to 100°C Ambient Environment	Individual Model Data Sheet
Storage Temperature	-55° to 100° C Ambient Environment	Individual Model Data Sheet
Humidity	90 to 95% RH, 240 hours, 50°C	MIL-STD-202, Method 103, Condition A, Except 50°C and end-point electrical test done within 12 hours
Solder Reflow Heat	Sn-Pb Eutetic Process: 225°C peak Pb-Free Process 245° - 250°C peak	J-STD-020, Table 4-1, 4-2 and 5-2, Figure 5-1
Solderability	10X Magnification	J-STD-002, Para 4.2.5, Test S, 95% Coverage
Vibration (High Frequency)	20g peak, 10-2000 Hz, 12 times in each of three perpendicular directions (total 36)	MIL-STD-202, Method 204, Condition D
Mechanical Shock	50g, 11 ms, 1/2-sine, 18 shocks: 3 each direction, each of 3 axes	MIL-STD-202, Method 213, Condition A