

Introducing IDC SSL Connector

The IDC SSL connector series are insulation displacement (IDC) SMT and thru-hole wire-to-board connectors designed for quick, tool-less termination of discrete wires onto LED printed circuit boards. These connectors use Tyco Electronics proven insulation displacement technology to provide a robust, stable electrical and mechanical power connection to single or multiple printed circuit boards in solid state lighting and non-lighting applications.

KEY FEATURES

- Available in 1, 2, 3 and 4 positions
- SMT and thru-hole
- Closed end and feed thru
- 18-24 AWG stranded and solid wire
- Dual IDC slots for redundancy
- Wire placement “viewing” window
- Wire gauge color coded
- Tool-less termination

APPLICATIONS

- LED lighting controls
- General illumination LED fixtures
- Connecting strings of pcb LED light modules
- Non-lighting wire-to-board applications

LIGHTING APPLICATIONS



Channel/Sign



Emergency

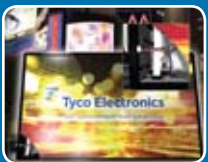

Digital Signage



Architectural



Street & Stadium



Indoor



Office



Commercial Refrigeration

ELECTRICAL

Operating Current : 8 AMPS (18 AWG only)

Maximum Operating Voltage : 250 VAC / 250 VDC

Dielectric Withstanding Voltage : 1500VAC

MECHANICAL

Operating Temperature : -40°C to 105°C

Wire Retention : 5 lbs. minimum

MATERIALS

Housings : 94 V0 rated high temperature resistant thermoplastic

Contacts : Tin over nickel plated copper alloy

STANDARDS AND SPECIFICATIONS

UL 1977

Design Objectives : 108-2404

Application Specification : 114-13266

Tape and Reel Packaging per EIA-481



PRODUCT DIMENSIONS

Closed End IDC SSL Connectors (SMT)

| PART NUMBER | POSITION | WIRE SIZE | DIM "D" | COLOR |
|-------------|----------|-----------|--------------|--------|
| 2106003-1 | 1 | 18 AWG | 5.70 [.224] | YELLOW |
| 2106003-2 | 2 | 18 AWG | 9.70 [.382] | YELLOW |
| 2106003-3 | 3 | 18 AWG | 13.70 [.539] | YELLOW |
| 2106003-4 | 4 | 18 AWG | 17.70 [.697] | YELLOW |
| 1-2106003-1 | 1 | 20 AWG | 5.70 [.224] | BLUE |
| 1-2106003-2 | 2 | 20 AWG | 9.70 [.382] | BLUE |
| 1-2106003-3 | 3 | 20 AWG | 13.70 [.539] | BLUE |
| 1-2106003-4 | 4 | 20 AWG | 17.70 [.697] | BLUE |
| 2-2106003-1 | 1 | 22 AWG | 5.70 [.224] | GREEN |
| 2-2106003-2 | 2 | 22 AWG | 9.70 [.382] | GREEN |
| 2-2106003-3 | 3 | 22 AWG | 13.70 [.539] | GREEN |
| 2-2106003-4 | 4 | 22 AWG | 17.70 [.697] | GREEN |
| 3-2106003-1 | 1 | 24 AWG | 5.70 [.224] | RED |
| 3-2106003-2 | 2 | 24 AWG | 9.70 [.382] | RED |
| 3-2106003-3 | 3 | 24 AWG | 13.70 [.539] | RED |
| 3-2106003-4 | 4 | 24 AWG | 17.70 [.697] | RED |

Closed End

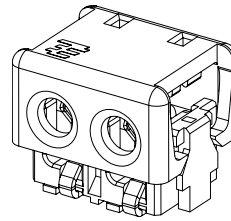

Feed Thru

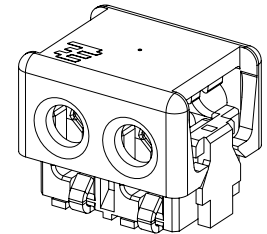

Product Dimensions

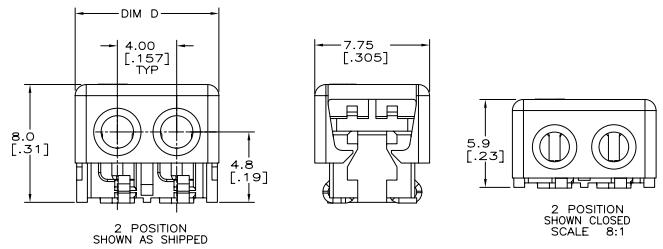

Feed Thru IDC SSL Connectors (SMT)

| PART NUMBER | POSITION | WIRE SIZE | DIM "D" | COLOR |
|-------------|----------|-----------|--------------|--------|
| 2106431-1 | 1 | 18 AWG | 5.70 [.224] | YELLOW |
| 2106431-2 | 2 | 18 AWG | 9.70 [.382] | YELLOW |
| 2106431-3 | 3 | 18 AWG | 13.70 [.539] | YELLOW |
| 2106431-4 | 4 | 18 AWG | 17.70 [.697] | YELLOW |
| 1-2106431-1 | 1 | 20 AWG | 5.70 [.224] | BLUE |
| 1-2106431-2 | 2 | 20 AWG | 9.70 [.382] | BLUE |
| 1-2106431-3 | 3 | 20 AWG | 13.70 [.539] | BLUE |
| 1-2106431-4 | 4 | 20 AWG | 17.70 [.697] | BLUE |
| 2-2106431-1 | 1 | 22 AWG | 5.70 [.224] | GREEN |
| 2-2106431-2 | 2 | 22 AWG | 9.70 [.382] | GREEN |
| 2-2106431-3 | 3 | 22 AWG | 13.70 [.539] | GREEN |
| 2-2106431-4 | 4 | 22 AWG | 17.70 [.697] | GREEN |
| 3-2106431-1 | 1 | 24 AWG | 5.70 [.224] | RED |
| 3-2106431-2 | 2 | 24 AWG | 9.70 [.382] | RED |
| 3-2106431-3 | 3 | 24 AWG | 13.70 [.539] | RED |
| 3-2106431-4 | 4 | 24 AWG | 17.70 [.697] | RED |

Recommended PCB Layout

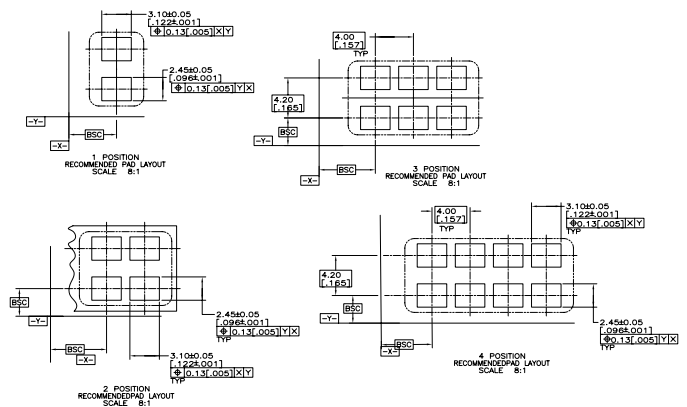

PRODUCT DIMENSIONS cont.

Closed End IDC SSL Connectors (Thru-Hole)

| PART NUMBER | POSITION | WIRE SIZE | DIM "D" | COLOR |
|-------------|----------|-----------|--------------|--------|
| 2106489-1 | 1 | 18 AWG | 5.70 [.224] | YELLOW |
| 2106489-2 | 2 | 18 AWG | 9.70 [.382] | YELLOW |
| 2106489-3 | 3 | 18 AWG | 13.70 [.539] | YELLOW |
| 2106489-4 | 4 | 18 AWG | 17.70 [.697] | YELLOW |
| 1-2106489-1 | 1 | 20 AWG | 5.70 [.224] | BLUE |
| 1-2106489-2 | 2 | 20 AWG | 9.70 [.382] | BLUE |
| 1-2106489-3 | 3 | 20 AWG | 13.70 [.539] | BLUE |
| 1-2106489-4 | 4 | 20 AWG | 17.70 [.697] | BLUE |
| 2-2106489-1 | 1 | 22 AWG | 5.70 [.224] | GREEN |
| 2-2106489-2 | 2 | 22 AWG | 9.70 [.382] | GREEN |
| 2-2106489-3 | 3 | 22 AWG | 13.70 [.539] | GREEN |
| 2-2106489-4 | 4 | 22 AWG | 17.70 [.697] | GREEN |
| 3-2106489-1 | 1 | 24 AWG | 5.70 [.224] | RED |
| 3-2106489-2 | 2 | 24 AWG | 9.70 [.382] | RED |
| 3-2106489-3 | 3 | 24 AWG | 13.70 [.539] | RED |
| 3-2106489-4 | 4 | 24 AWG | 17.70 [.697] | RED |

Closed End

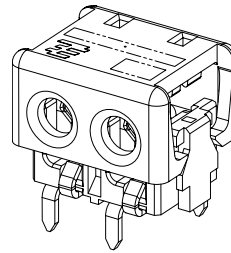

Feed Thru

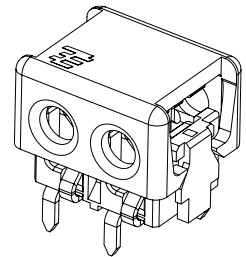

Product Dimensions

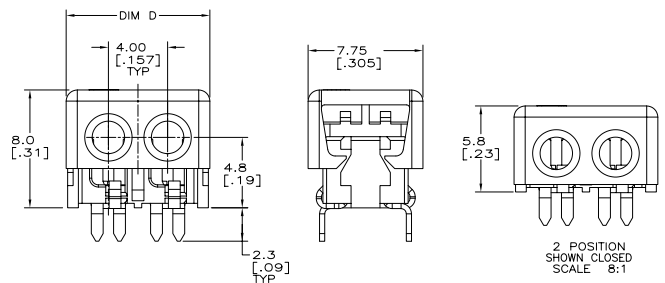

Feed Thru IDC SSL Connectors (Thru-Hole)

| PART NUMBER | POSITION | WIRE SIZE | DIM "D" | COLOR |
|-------------|----------|-----------|--------------|--------|
| 2106751-1 | 1 | 18 AWG | 5.70 [.224] | YELLOW |
| 2106751-2 | 2 | 18 AWG | 9.70 [.382] | YELLOW |
| 2106751-3 | 3 | 18 AWG | 13.70 [.539] | YELLOW |
| 2106751-4 | 4 | 18 AWG | 17.70 [.697] | YELLOW |
| 1-2106751-1 | 1 | 20 AWG | 5.70 [.224] | BLUE |
| 1-2106751-2 | 2 | 20 AWG | 9.70 [.382] | BLUE |
| 1-2106751-3 | 3 | 20 AWG | 13.70 [.539] | BLUE |
| 1-2106751-4 | 4 | 20 AWG | 17.70 [.697] | BLUE |
| 2-2106751-1 | 1 | 22 AWG | 5.70 [.224] | GREEN |
| 2-2106751-2 | 2 | 22 AWG | 9.70 [.382] | GREEN |
| 2-2106751-3 | 3 | 22 AWG | 13.70 [.539] | GREEN |
| 2-2106751-4 | 4 | 22 AWG | 17.70 [.697] | GREEN |
| 3-2106751-1 | 1 | 24 AWG | 5.70 [.224] | RED |
| 3-2106751-2 | 2 | 24 AWG | 9.70 [.382] | RED |
| 3-2106751-3 | 3 | 24 AWG | 13.70 [.539] | RED |
| 3-2106751-4 | 4 | 24 AWG | 17.70 [.697] | RED |

Recommended PCB Layout

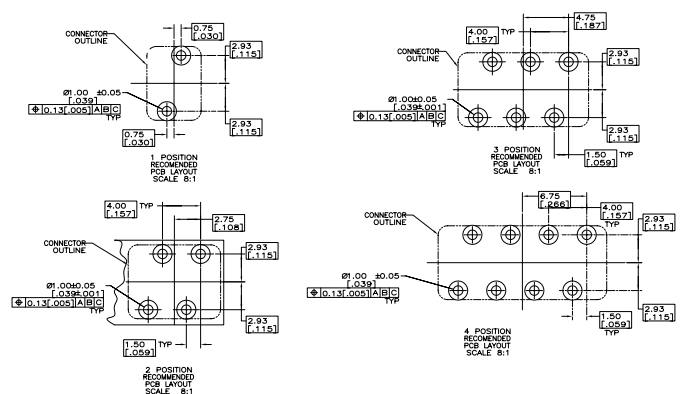

IDC SSL Connector



TERMINATION SEQUENCE

As shipped

(staged configurations)

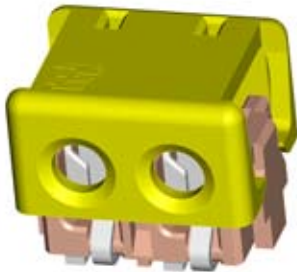

Insert unstripped wire

(solid or stranded)



Fully inserted wire

(wire retained and visible through "viewing" window)



Tool-less terminated wire

(closed configuration)



Questions to ask at design in

What wire gauge and insulation type will you be using?

The connectors accept 18-24 AWG stranded and solid wire (separate part numbers per wire size and connector type) with varying maximum insulation outside diameters per wire gauge.

What should be the design criteria for choosing either the closed end or feed thru versions of the connectors?

Closed end connectors should be chosen when attaching power leads to a single printed circuit board. However, in applications that require bringing power to multiple printed circuit boards, feed thru connectors provide a more flexible solution.

Is your manufacturing process automated?

The connectors are manufactured in high temperature plastic material and tape and reel packaged for high speed SMT reflow or thru-hole wave solder processing.

What application tooling options are available?

The pre-assembled connector cover serves two purposes: One, it positions and retains the wire in the pre-stage position. Two, it serves as a wire stuffer for tool-less termination while providing strain relief to the terminated wire. Customers should provide simple "flat rock" tooling to fully seat the cover to complete the termination process.

What mechanical and electrical testing has the connectors been subjected to that validates their long term performance?

The TE Product Specification 108-2404 provides a summary of the test groups, sequences and results that the product was subjected in to during product qualification testing.

What applications dictate the use of either surface mount or thru hole connectors?

The SMT connectors will be used in the majority of the LED applications on aluminum clad printed circuit boards. However, for non-lighting applications that require bringing wire leads to FR4 printed circuit boards mounted with thru hole components, customers will find the thru-hole connectors more advantageous.

What special retention mechanisms are available to help ensure PCB stability?

The Thru-hole connectors have two off-set legs per terminal and the SMT connectors have solder tabs to help ensure printed circuit board stability.

FOR MORE INFORMATION : www.tycoelectronics.com/lighting

Technical Support

| | |
|---------------------------|--|
| Internet: | www.tycoelectronics.com/help |
| USA: | +1 (800) 522-6752 |
| Canada: | +1 (905) 470-4425 |
| Mexico & Central America: | +52(0) 55-1106-0814 |
| South America: | +55 (0) 11-2103-6000 |
| Germany: | +49 (0) 6251-133-1999 |
| UK: | +44 (0) 800-267666 |
| France: | +33 (0) 1-3420-8686 |
| Netherlands: | +31 (0) 73-6246-999 |
| China: | +86 (0) 400-820-6015 |

Part numbers in this brochure are RoHS Compliant*, unless marked otherwise.

*as defined www.tycoelectronics.com/leadfree

Tyco Electronics Corporation

Harrisburg, PA

tycoelectronics.com

© 2010 Tyco Electronics Corporation All Rights Reserved.

5-1773455-1 3M FP 02/2010

TE (logo) and Tyco Electronics are trademarks of the Tyco Electronics group of companies and its licensors.

Other products, logos, and Company names mentioned herein may be trademarks of their respective owners.

While Tyco Electronics has made every reasonable effort to ensure the accuracy of the information in this catalog, Tyco Electronics does not guarantee that it is error-free, nor does Tyco Electronics make any other representation, warranty or guarantee that the information is accurate, correct, reliable or current. Tyco Electronics reserves the right to make any adjustments to the information contained herein at any time without notice. Tyco Electronics expressly disclaims all implied warranties regarding the information contained herein, including, but not limited to, any implied warranties of merchantability or fitness for a particular purpose. The dimensions in this catalog are for reference purposes only and are subject to change without notice. Specifications are subject to change without notice. Consult Tyco Electronics for the latest dimensions and design specifications.