

3400⇒3402/3405/3410



Basic Part Number	Shoulder Height V	Length S	Length L
3402-0	.052	.138	.115
3401-0	.100	.136	.115
3405-0	.169	.146	.115
3400-0	.461	.145	.115
3410-0	.934	.136	.124

34XX-0-00-XX-00-00-03-0
Press-fit in .057 mounting hole

3411

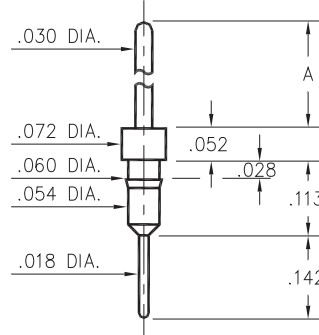

Basic Part Number	Pin Length A
3411-0	.417
3411-1	.217

3411-X-00-XX-00-00-03-0
Press-fit in .057 mounting hole

0600



0600-0-05-XX-00-00-01-0
Solder mount in .052 mounting hole

0290



0290-0-00-XX-00-00-03-0
Press-fit in .057 mounting hole

7007

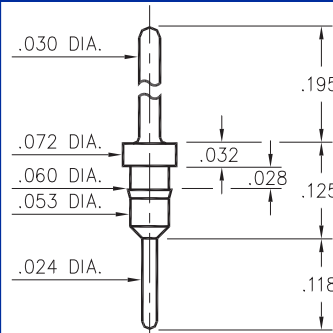

7007-0-00-XX-00-00-03-0
Press-fit in .057 mounting hole

5016

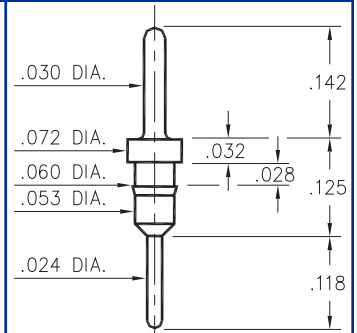

5016-0-00-XX-00-00-03-0
Press-fit in .057 mounting hole

5005



5005-0-00-XX-00-00-03-0
Press-fit in .057 mounting hole

5107

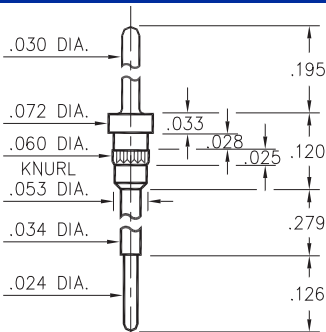

5107-0-00-XX-00-00-03-0
Press-fit in .057 mounting hole

8919

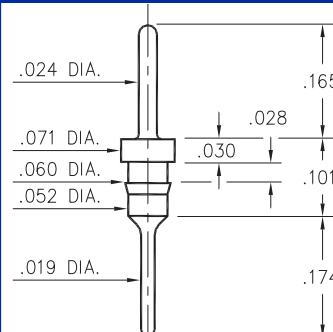

8919-0-00-XX-00-00-03-0
Press-fit in .057 mounting hole

3077

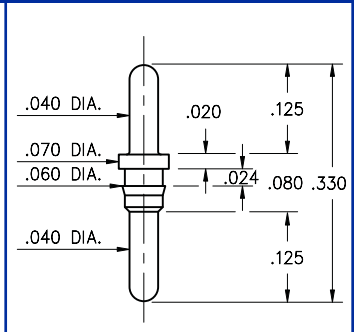

3077-0-00-XX-00-00-03-0
Press-fit in .057 mounting hole

SPECIFICATIONS

PIN MATERIAL:
Brass Alloy 360, 1/2 Hard
(Except where noted)

DIMENSION IN INCHES
TOLERANCES ON:
LENGTHS: ±.005
DIAMETERS: ±.002
ANGLES: ± 2°

ORDER CODE: XXXX - X - 0X - XX - 00 - 00 - XX - 0

BASIC PART #

SPECIFY PIN FINISH:

- 01 200µ" TIN/LEAD OVER NICKEL
- ◇ 80 200µ" TIN OVER NICKEL (RoHS)
- ◇ 15 10µ" GOLD OVER NICKEL (RoHS)
- ◇ 21 20µ" GOLD OVER NICKEL (RoHS)
- ◇ 34 50µ" GOLD OVER NICKEL (RoHS)

