



BC846-BC850

NPN SILICON TRANSISTOR

SWITCHING AND AMPLIFIER APPLICATION

FEATURES

- * Suitable for automatic insertion in thick and thin-film circuits.
- * Complement to BC856 ... BC860

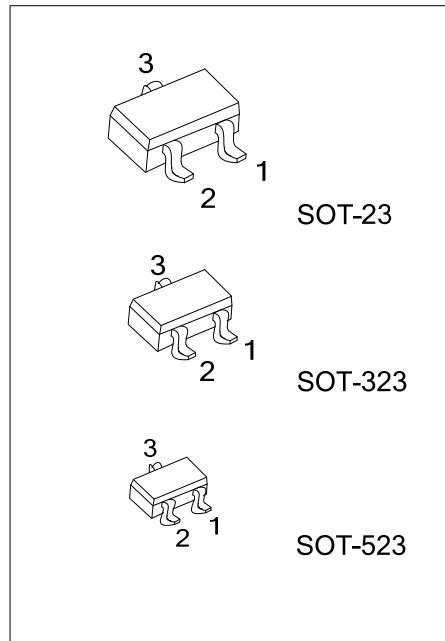

ORDERING INFORMATION

Ordering Number		Package	Pin Assignment			Packing
Lead Free	Halogen Free		1	2	3	
BC846L-x-AE3-R	BC846G-x-AE3-R	SOT-23	E	B	C	Tape Reel
BC847L-x-AE3-R	BC847G-x-AE3-R	SOT-23	E	B	C	Tape Reel
BC848L-x-AE3-R	BC848G-x-AE3-R	SOT-23	E	B	C	Tape Reel
BC849L-x-AE3-R	BC849G-x-AE3-R	SOT-23	E	B	C	Tape Reel
BC850L-x-AE3-R	BC850G-x-AE3-R	SOT-23	E	B	C	Tape Reel
BC846L-x-AL3-R	BC846G-x-AL3-R	SOT-323	E	B	C	Tape Reel
BC847L-x-AL3-R	BC847G-x-AL3-R	SOT-323	E	B	C	Tape Reel
BC848L-x-AL3-R	BC848G-x-AL3-R	SOT-323	E	B	C	Tape Reel
BC849L-x-AL3-R	BC849G-x-AL3-R	SOT-323	E	B	C	Tape Reel
BC850L-x-AL3-R	BC850G-x-AL3-R	SOT-323	E	B	C	Tape Reel
BC846L-x-AN3-R	BC846G-x-AN3-R	SOT-523	E	B	C	Tape Reel
BC847L-x-AN3-R	BC847G-x-AN3-R	SOT-523	E	B	C	Tape Reel
BC848L-x-AN3-R	BC848G-x-AN3-R	SOT-523	E	B	C	Tape Reel
BC849L-x-AN3-R	BC849G-x-AN3-R	SOT-523	E	B	C	Tape Reel
BC850L-x-AN3-R	BC850G-x-AN3-R	SOT-523	E	B	C	Tape Reel

<p>BC846L-x-AE3-R</p> <p>(1) Packing Type (2) Package Type (3) Rank (4) Lead Free</p>	<p>(1) R: Tape Reel (2) AE3: SOT-23, AL3: SOT-323, AN3: SOT-523 (3) x: refer to Classification of h_{FE} (4) G: Halogen Free, L: Lead Free</p>
---	---

BC846-BC850

NPN SILICON TRANSISTOR

MARKING

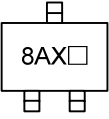
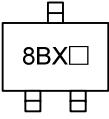
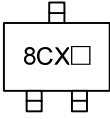
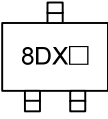
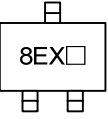
BC846	BC847	BC848	BC849	BC850
				

X: Rank Code, refer to Classification of h_{FE}

□: L: Lead Free, G: Halogen Free

BC846-BC850

NPN SILICON TRANSISTOR

■ ABSOLUTE MAXIMUM RATING ($T_A=25^{\circ}\text{C}$, unless otherwise specified)

PARAMETER		SYMBOL	VALUE	UNIT
Collector-Base Voltage	BC846	V_{CBO}	80	V
	BC847 / BC850		50	V
	BC848 / BC849		30	V
Collector-Emitter Voltage	BC846	V_{CEO}	65	V
	BC847 / BC850		45	V
	BC848 / BC849		30	V
Emitter-Base Voltage	BC846 / BC847	V_{EBO}	6	V
	BC848 / BC849 / BC850		5	V
Collector Current (DC)		I_C	100	mA
Collector Dissipation	SOT-23	P_D	310	mW
	SOT-323		200	mW
	SOT-523		150	mW
Junction Temperature		T_J	+150	$^{\circ}\text{C}$
Storage Temperature		T_{STG}	-40 ~ +150	$^{\circ}\text{C}$

Note: Absolute maximum ratings are those values beyond which the device could be permanently damaged.

Absolute maximum ratings are stress ratings only and functional device operation is not implied.

■ ELECTRICAL CHARACTERISTICS ($T_A=25^{\circ}\text{C}$, unless otherwise specified)

PARAMETER		SYMBOL	TEST CONDITIONS	MIN	TYP	MAX	UNIT
Collector Cut-Off Current		I_{CBO}	$V_{CB}=30\text{V}, I_E=0$			15	nA
DC Current Gain		h_{FE}	$V_{CE}=5.0\text{V}, I_C=2.0\text{mA}$	110		800	
Collector-Emitter Saturation Voltage	$V_{CE(SAT)}$		$I_C=10\text{mA}, I_B=0.5\text{mA}$		90	250	mV
			$I_C=100\text{mA}, I_B=5.0\text{mA}$		200	600	mV
Collector-Base Saturation Voltage	$V_{BE(SAT)}$		$I_C=10\text{mA}, I_B=0.5\text{mA}$		700		mV
			$I_C=100\text{mA}, I_B=5.0\text{mA}$		900		mV
Base-Emitter On Voltage	$V_{BE(ON)}$		$V_{CE}=5.0\text{V}, I_C=2.0\text{mA}$	580	660	700	mV
			$V_{CE}=5.0\text{V}, I_C=10\text{mA}$			720	mV
Current Gain Bandwidth Product		f_T	$V_{CE}=5.0\text{V}, I_C=10\text{mA}, f=100\text{MHz}$		300		MHz
Output Capacitance		C_{OB}	$V_{CB}=10\text{V}, I_E=0, f=1.0\text{MHz}$		3.5	6	pF
Input Capacitance		C_{IB}	$V_{EB}=0.5\text{V}, I_C=0, f=1.0\text{MHz}$		9		pF
Noise Figure		NF	$V_{CE}=5\text{V}, I_C=200\mu\text{A},$ $f=1\text{KHz}, R_G=2\text{K}\Omega$		2	10	dB
					1.2	4	dB
					1.4	4	dB
					1.4	3	dB

■ CLASSIFICATION OF h_{FE}

RANK	A	B	C
RANGE	110-220	200-450	420-800

TYPICAL CHARACTERISTICS

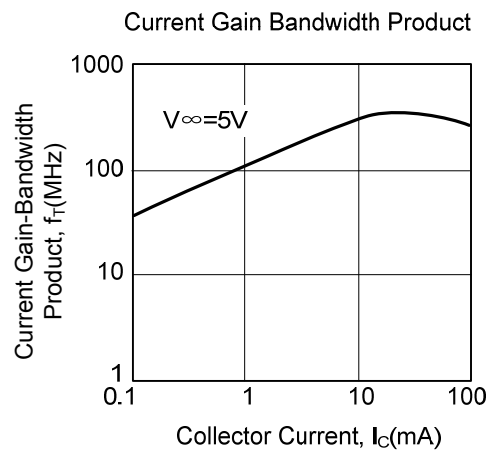
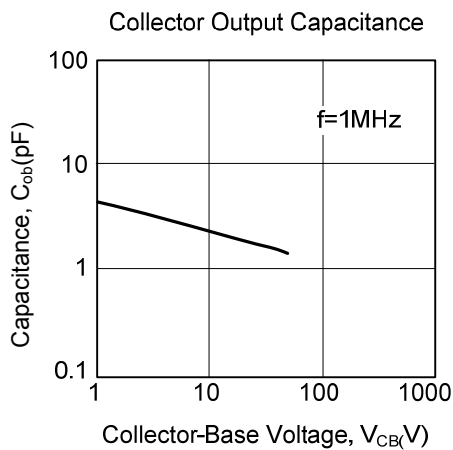
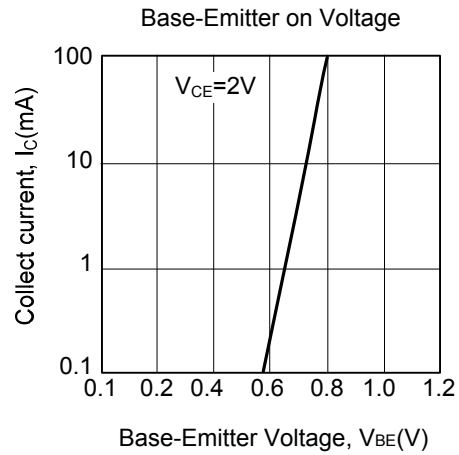
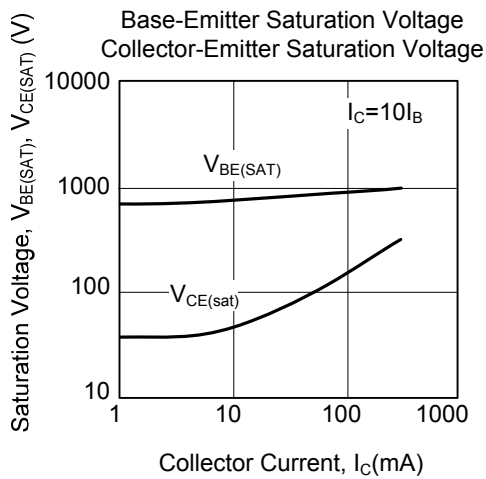
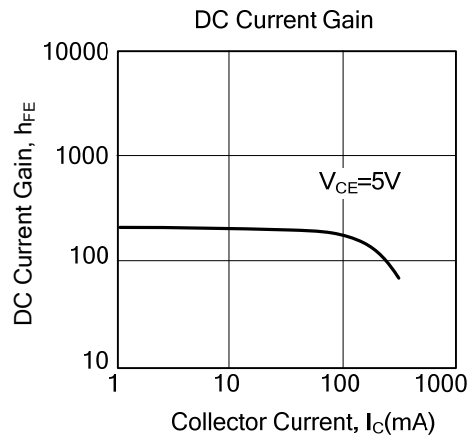
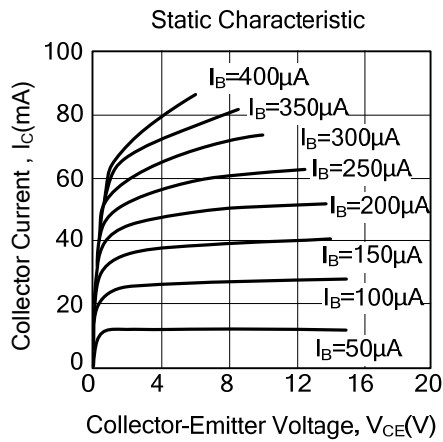

UTC assumes no responsibility for equipment failures that result from using products at values that exceed, even momentarily, rated values (such as maximum ratings, operating condition ranges, or other parameters) listed in products specifications of any and all UTC products described or contained herein. UTC products are not designed for use in life support appliances, devices or systems where malfunction of these products can be reasonably expected to result in personal injury. Reproduction in whole or in part is prohibited without the prior written consent of the copyright owner. The information presented in this document does not form part of any quotation or contract, is believed to be accurate and reliable and may be changed without notice.