

Coiltronics MPI5451 Series

High current, low profile power inductors



Applications

- Handheld/mobile devices
- Portable media players
- MP3 Players
- Battery operated devices
- Notebook/netbook
- Tablets/smartbooks
- LCD Displays
- LED Drivers

Environmental data

- Storage temperature range (Component): -40°C to +125°C
- Operating temperature range: -40°C to +125°C (ambient + self-temperature rise)
- Solder reflow temperature: J-STD-020D compliant

Product description

- Halogen free, lead free, RoHS compliant
- 125°C maximum total temperature operation
- 5.74 x 5.43 footprint surface mount package with either 1.2 or 2.0mm heights
- Magnetically shielded, low EMI
- Rugged construction
- Inductance range from 0.33µH to 15µH
- Current range from 1.1 to 11.5 amps

Packaging

- Supplied in tape and reel packaging on a 13" diameter reel



Discontinued, Effective February 1, 2016 or until inventory is depleted. No recommendation available replacement available



The Coiltronics brand of magnetics (formerly of the Bussmann Division of Cooper Industries) is now part of Eaton's Electrical Group, Electronics Division.

Coiltronics is now part of Eaton
Same great products plus even more.

Product specifications

Part Number ⁵	OCL ¹ (μH) $\pm 20\%$	I_{rms}^2 (Amps)	I_{sat}^3 (Amps)	DCR ($\text{m}\Omega$) @ 25°C $\pm 20\%$	K-Factor ⁴
R1 - 1.2mm height					
MPI5451R1-R33-R	0.33	6.5	11.5	13	1244
MPI5451R1-R47-R	0.47	6.1	10.9	18	995
MPI5451R1-1R0-R	1.0	4.2	7.2	30	622
MPI5451R1-1R5-R	1.5	3.4	6.1	48	498
MPI5451R1-2R2-R	2.2 $\pm 15\%$	2.6	4.8	70	452
MPI5451R1-3R3-R	3.3 $\pm 15\%$	2.3	3.8	95	355
MPI5451R1-4R7-R	4.7 $\pm 15\%$	2.1	3.5	120	293
MPI5451R1-5R6-R	5.6 $\pm 15\%$	1.9	3.1	145	249
MPI5451R1-6R8-R	6.8 $\pm 15\%$	1.7	2.8	175	237
MPI5451R1-100-R	10.0 $\pm 15\%$	1.3	2.5	290	199
MPI5451R1-150-R	15.0 $\pm 15\%$	1.1	2.2	400	155
R3 - 2.0mm height					
MPI5451R3-R47-R	0.47	6.0	9.0	8.8	1244
MPI5451R3-R68-R	0.68	5.9	8.0	9.5	995
MPI5451R3-1R0-R	1.0	5.1	6.6	14	711
MPI5451R3-1R5-R	1.5	5.0	5.8	16	553
MPI5451R3-2R2-R	2.2	4.1	5.0	24	452
MPI5451R3-3R3-R	3.3	3.7	4.2	33	383
MPI5451R3-4R7-R	4.7	3.0	3.8	50	293
MPI5451R3-6R8-R	6.8	2.6	3.0	70	249
MPI5451R3-100-R	10.0	2.1	2.4	110	207

- Open Circuit Inductance (OCL) Test Parameters: 100kHz, 0.1V_{rms}, 0.0Adc, 25°C
- I_{rms} : DC current for an approximate temperature rise of 40°C without core loss. Derating is necessary for AC currents. PCB layout, trace thickness and width, air-flow, and proximity of other heat generating components will affect the temperature rise. It is recommended that the temperature of the part not exceed 125°C under worst case operating conditions verified in the end application.
- I_{sat} : Peak current for approximately 20% rolloff at +25°C

- K-factor: Used to determine B_{pp} for core loss (see graph). $B_{\text{pp}} = K * L * \Delta I$. B_{pp} : (Gauss), K: (K-factor from table), L: (Inductance in μH), ΔI (Peak to peak ripple current in Amps).
- Part Number Definition: MPI5451Rx-yyy-R
 - MPI5451Rx = Product code and size
 - yyy= Inductance value in μH , R = decimal point, if no R is present then third character = number of zeros
 - "R" suffix = RoHS compliant

Dimensions - mm

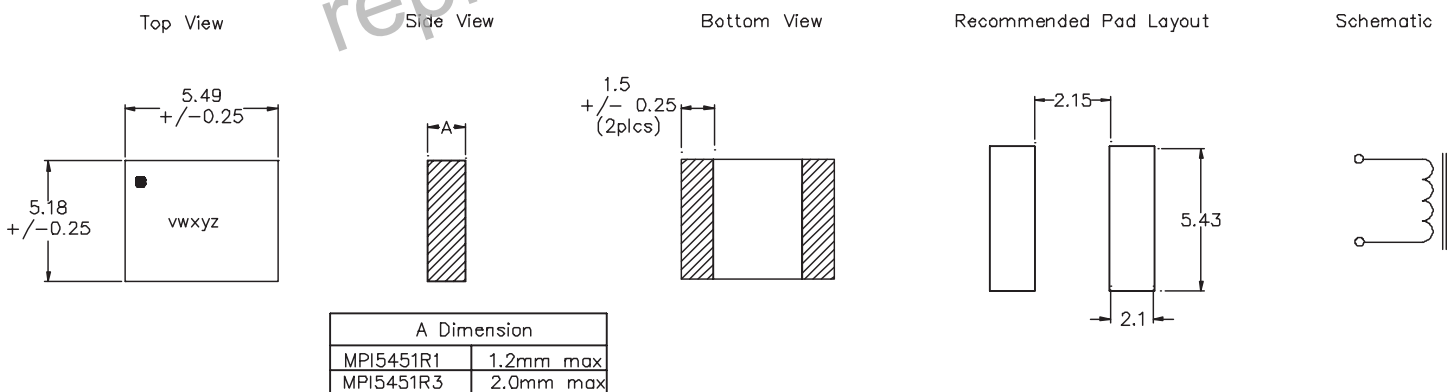

Part Marking : wxyz
 v = height: 1 = R1 (1.2mm), 3 = R3 (2.0mm)
 w = inductance value per the "Part Marking Designator" letter code in table above
 x = Bi-weekly date code
 y = Last digit of year manufactured
 z = Revision level

Packaging information - mm

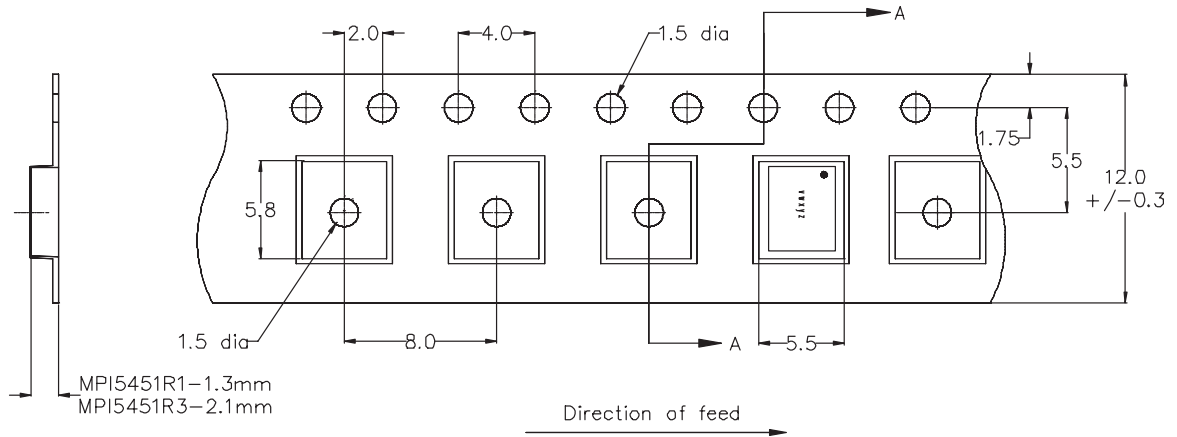

Section A-A

Supplied in tape and reel packaging.
MPI5451R1 4000 parts per 13" diameter reel
MPI5451R3 3000 parts per 13" diameter reel

Core loss

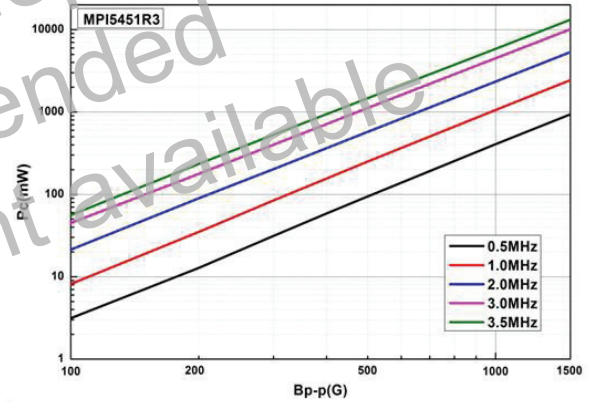
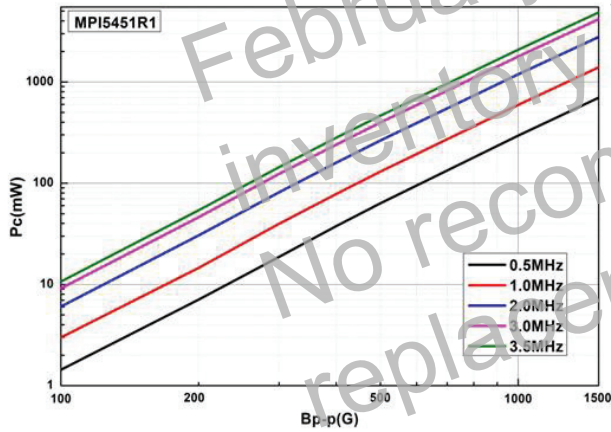

Discontinued, Effective February 1, 2016 or until inventory is depleted. No recommendation for replacement available.

Inductance characteristics / temperature rise

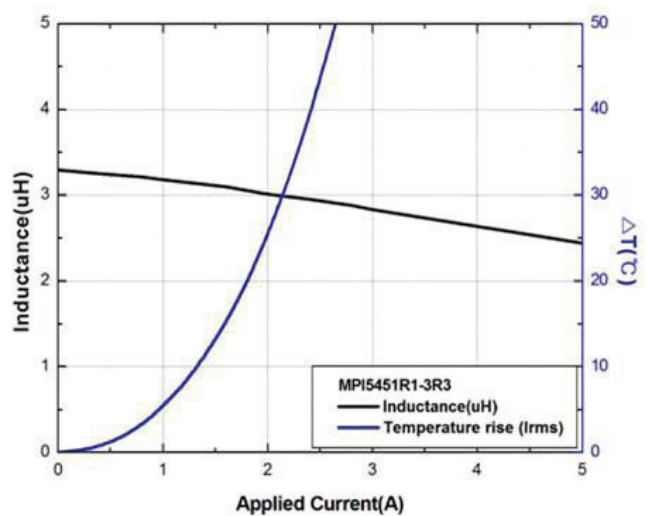
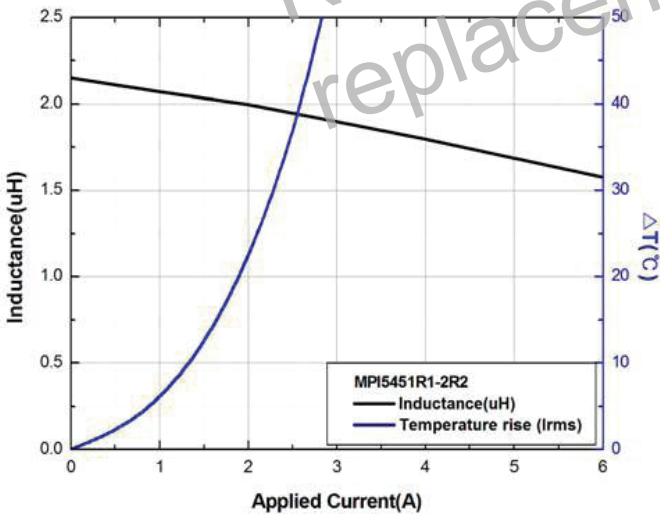
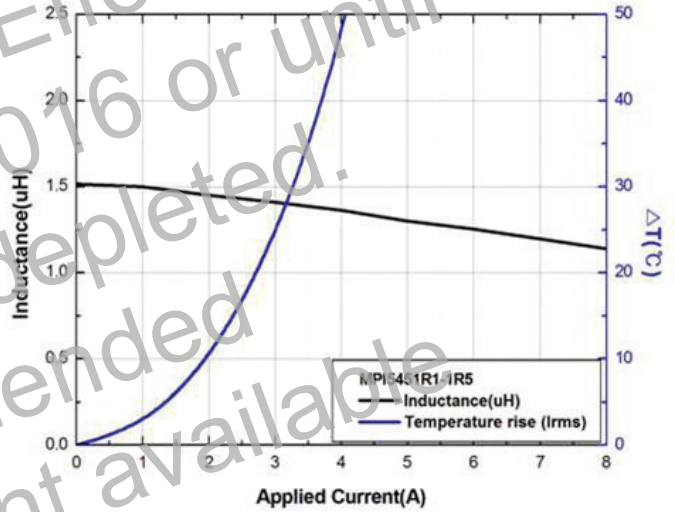
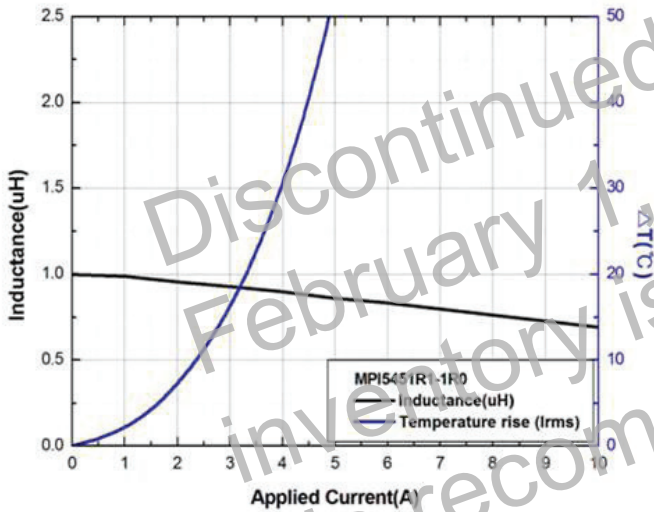
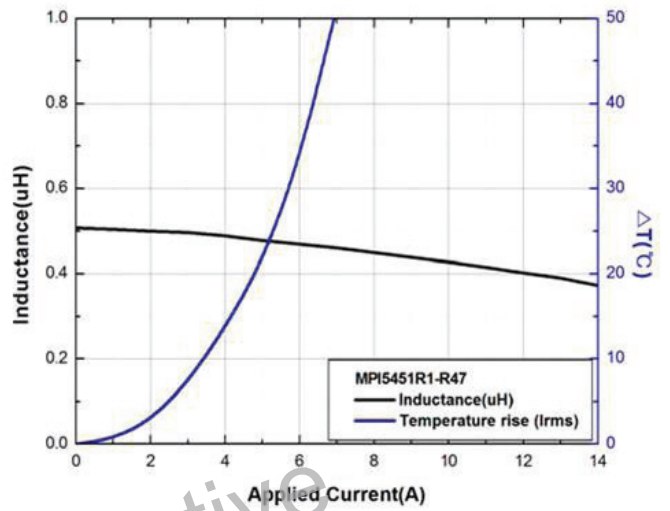
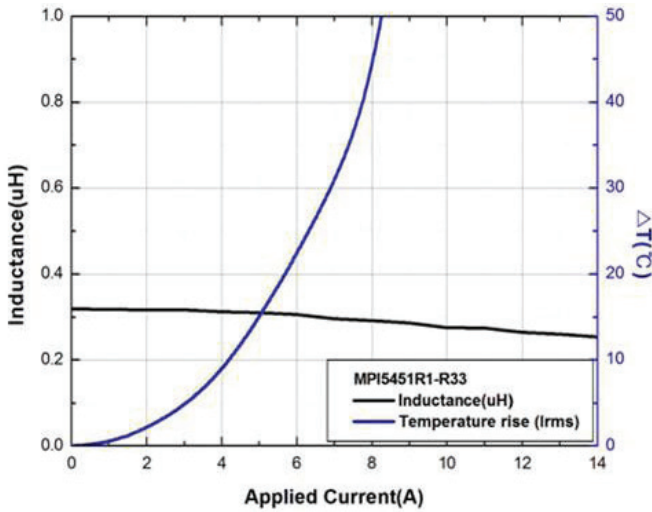

Inductance characteristics / temperature rise

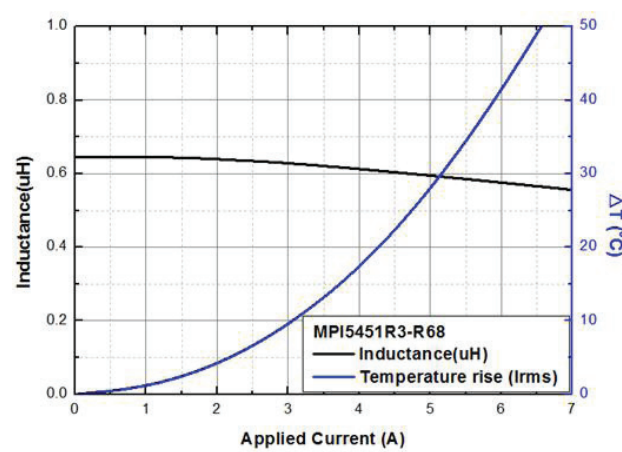
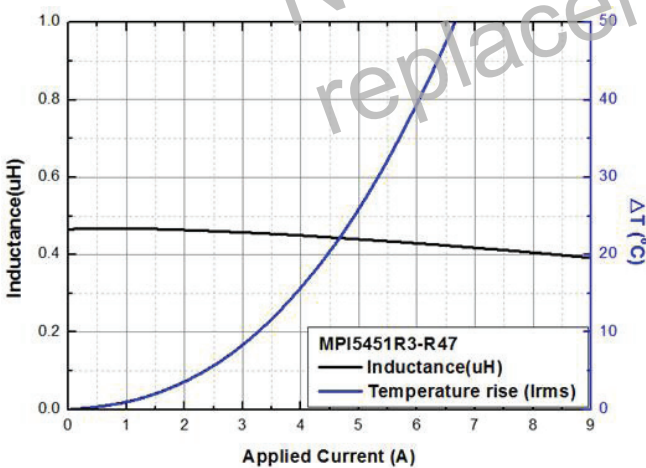
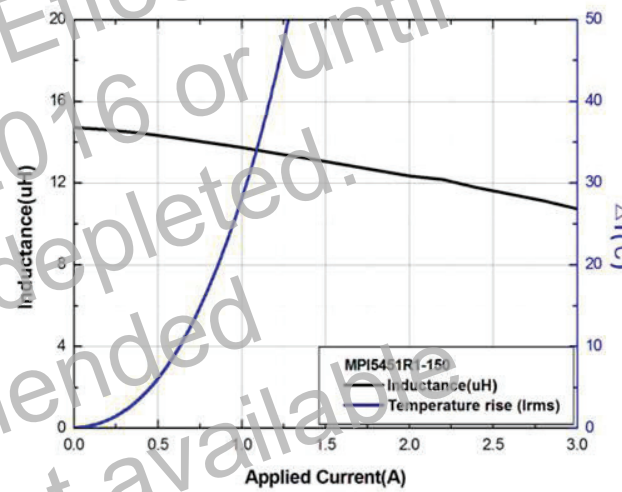
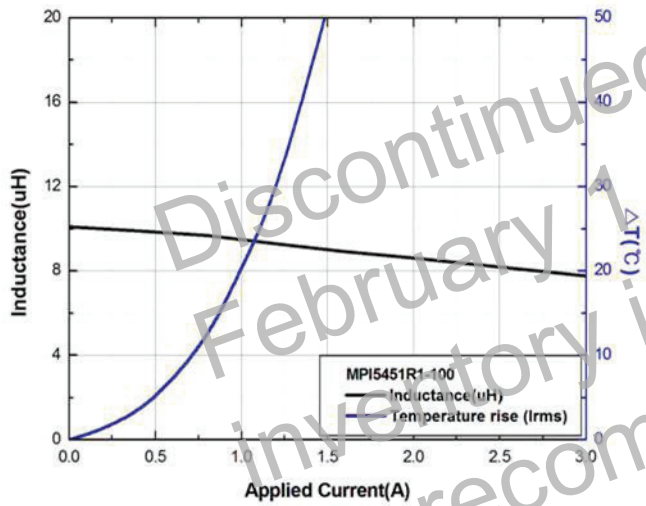
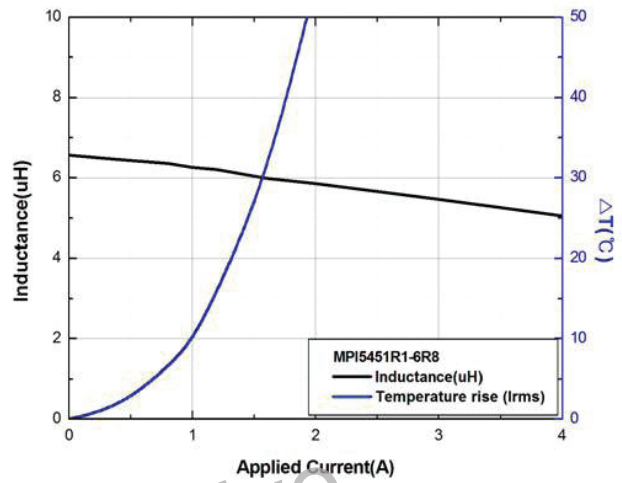
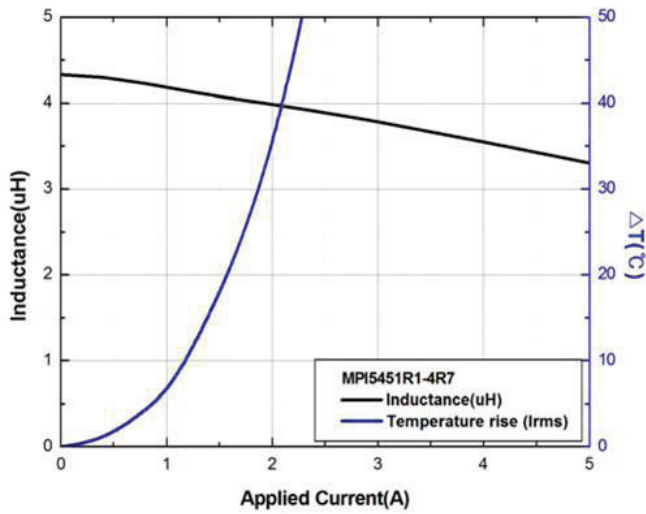

Inductance characteristics / temperature rise

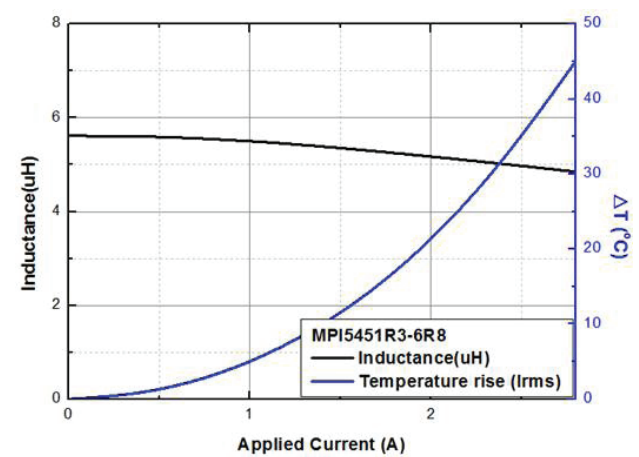
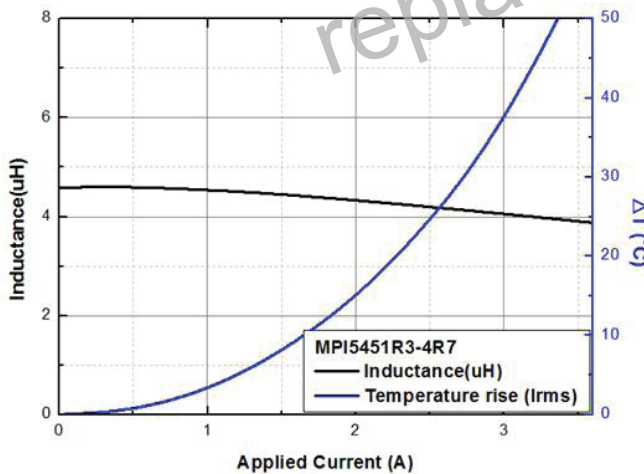
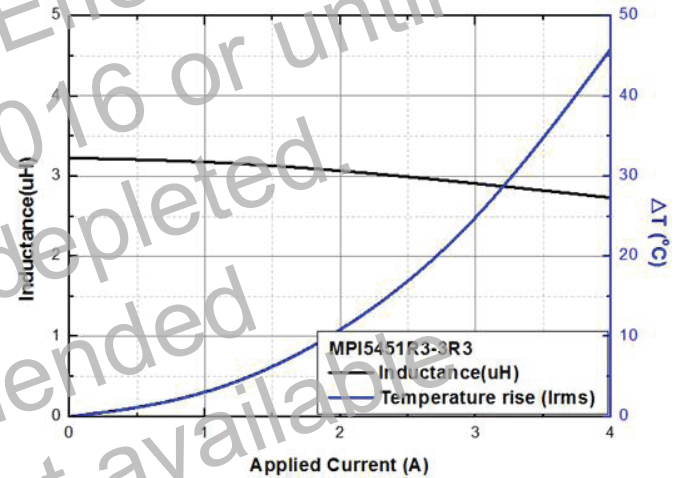
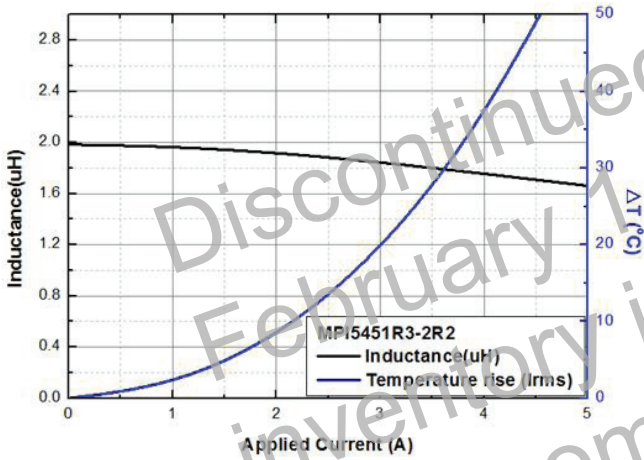
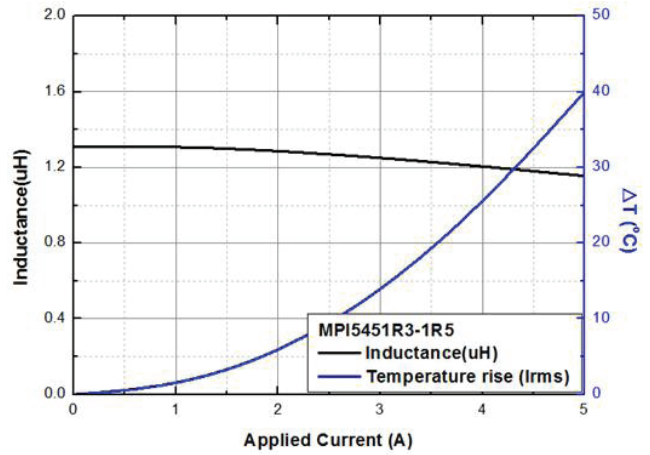
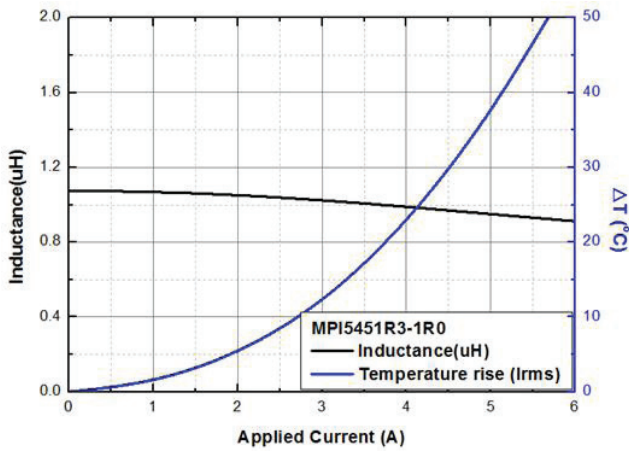

Inductance characteristics / temperature rise

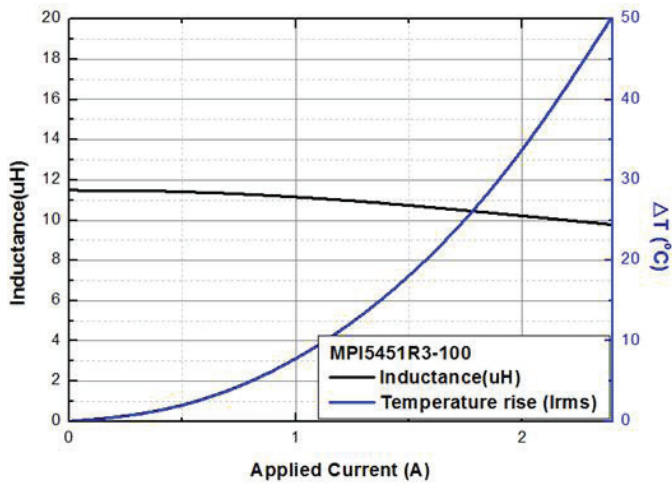

Discontinued, Effective
February 1, 2016 or until
inventory is depleted.
No recommended
replacement available

Solder reflow profile

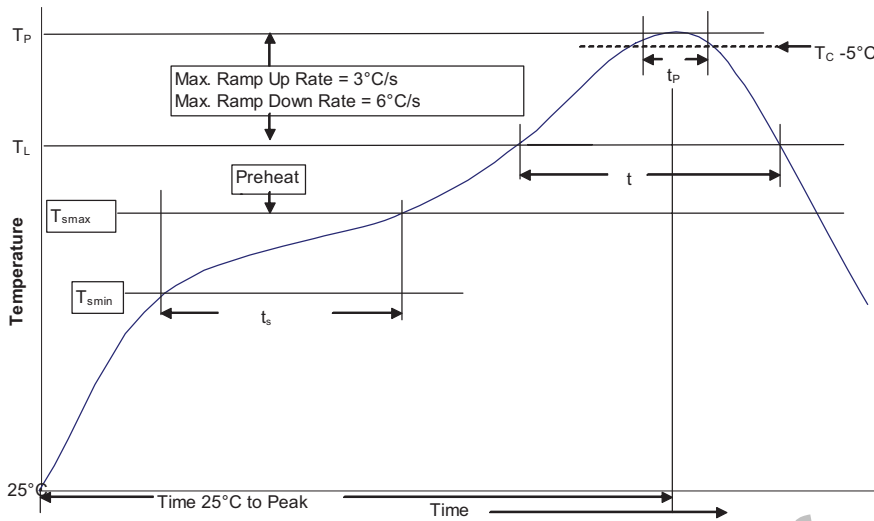

Table 1 - Standard SnPb Solder (T_C)

Package Thickness	Volume ≤ 350 mm ³	Volume ≥ 350 mm ³
<2.5mm	235°C	220°C
≥ 2.5 mm	220°C	220°C

Table 2 - Lead (Pb) Free Solder (T_C)

Package Thickness	Volume ≤ 350 mm ³	Volume 350 - 2000 mm ³	Volume > 2000 mm ³
<1.6mm	260°C	260°C	260°C
1.6 – 2.5mm	260°C	250°C	245°C
>2.5mm	250°C	245°C	245°C

Reference JDEC J-STD-020D

Profile Feature	Standard SnPb Solder	Lead (Pb) Free Solder
Preheat and Soak	100°C	150°C
• Temperature min. (T_{smin})		
• Temperature max. (T_{smax})	150°C	200°C
• Time (T_{smin} to T_{smax}) (t_s)	60-120 Seconds	60-120 Seconds
Average ramp up rate T_{smax} to T_p	3°C/ Second Max.	3°C/ Second Max.
Liquidous temperature (T_L)	183°C	217°C
Time at liquidous (t_L)	60-150 Seconds	60-150 Seconds
Peak package body temperature (T_p)	Table 1	Table 2
Time (t_p)** within 5 °C of the specified classification temperature (T_C)	20 Seconds**	30 Seconds**
Average ramp-down rate (T_p to T_{smax})	6°C/ Second Max.	6°C/ Second Max.
Time 25°C to Peak Temperature	6 Minutes Max.	8 Minutes Max.

* Tolerance for peak profile temperature (T_p) is defined as a supplier minimum and a user maximum.

** Tolerance for time at peak profile temperature (t_p) is defined as a supplier minimum and a user maximum.

North America
Eaton's Electrical Group
Electronics Division
1225 Broken Sound Parkway NW
Suite F
Boca Raton, FL 33487-3533
Tel: 1-561-998-4100
Fax: 1-561-241-6640
Toll Free: 1-888-414-2645

Eaton's Electrical Group
Electronics Division
P.O. Box 14460
St. Louis, MO 63173-4460
Tel: 1-636-394-2877
Fax: 1-636-527-1607

Europe
Eaton's Electrical Group
Electronics Division
Burton-on-the-Wolds
Leicestershire, LE 12 5th UK
Phone: +44 (0) 1509 882 600
Fax: +44 (0) 1509 882 786

Eaton's Electrical Group
Electronics Division
Avda Santa Eulalia, 290
Terrassa, Barcelona 08223 Spain
Phone: +34-93-736-2813
Fax: +34-93-783-5055

Asia Pacific
Eaton's Electrical Group
Electronics Division
No.2, #06-01
Serangoon North Avenue 5
Singapore 554911
Tel: +65 6645 9888
Fax: +65 6728 3155

The only controlled copy of this Data Sheet is the electronic read-only version located on the Bussmann Network Drive. All other copies of this document are by definition uncontrolled. This bulletin is intended to clearly present comprehensive product data and provide technical information that will help the end user with design applications. Bussmann reserves the right, without notice, to change design or construction of any products and to discontinue or limit distribution of any products. Bussmann also reserves the right to change or update, without notice, any technical information contained in this bulletin. Once a product has been selected, it should be tested by the user in all possible applications.

Life Support Policy: Bussmann does not authorize the use of any of its products for use in life support devices or systems without the express written approval of an officer of the Company. Life support systems are devices which support or sustain life, and whose failure to perform, when properly used in accordance with instructions for use provided in the labeling, can be reasonably expected to result in significant injury to the user.

Eaton's Electrical Group
Electronics Division
114 Old State Road
Ellisville, MO 63021
United States
www.eaton.com/elx

© 2014 Eaton
All Rights Reserved
Publication No. 10247 — BU-SB14346
June 2014

Eaton is a registered trademark.

All other trademarks are property of their respective owners.



Powering Business Worldwide