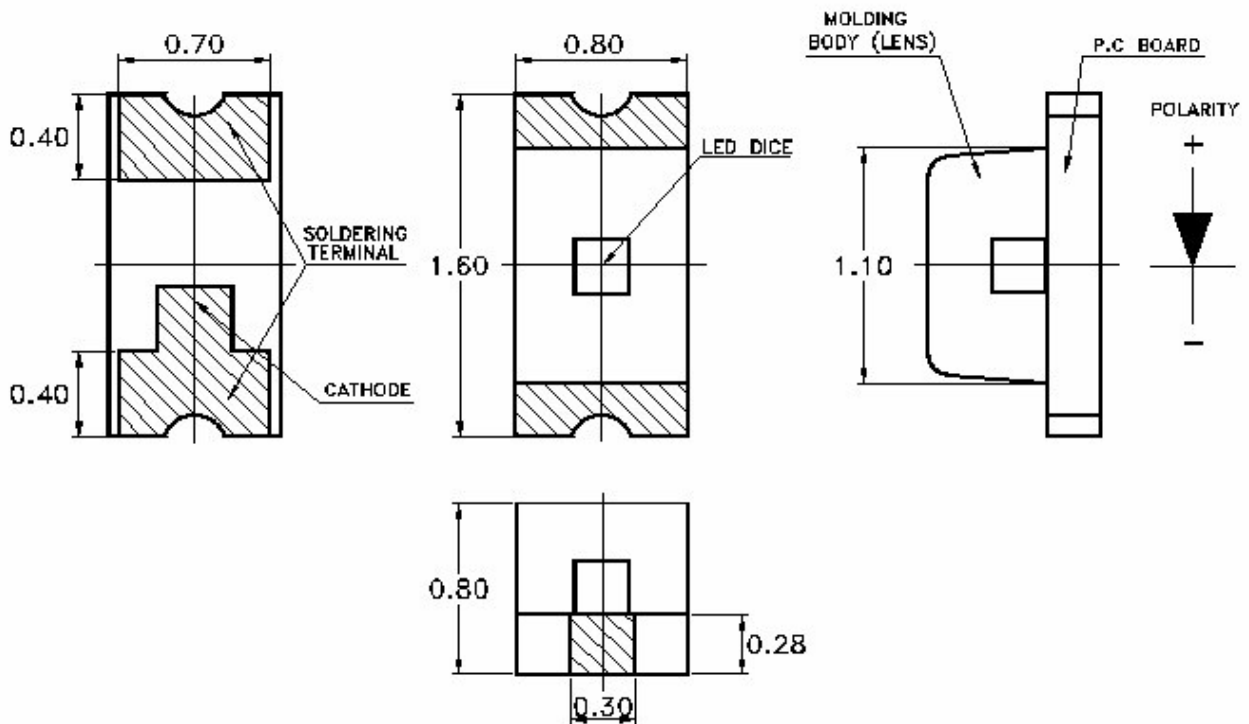

Features:

- * Package In 8mm Tape On 7" Diameter Reels.
- * Compatible With Automatic Placement Equipment.
- * Compatible With Infrared Reflow Solder Process
- * EIA STD package.
- * Meet ROHS, Green Product.

Package Dimensions**Notes:**

1. All dimensions are in millimeters (inches).
2. Tolerance is ± 0.10 mm (.004") unless otherwise noted.
3. Specifications are subject to change without notice.

ABSOLUTE MAXIMUM RATINGS AT TA=25°C

PARAMETER	MAXIMUM RATING	UNIT
Power Dissipation	75	mW
Peak Forward Current (300pps, 10 μs pulse)	1	A
Continuous Forward Current	50	mA
Reverse Voltage	5	V
Operating Temperature Range	-40°C to + 85°C	
Storage Temperature Range	-55°C to + 100°C	
Infrared Soldering Condition	260°C For 10 Seconds	

Suggestion Profile:

Suggestion IR Reflow Profile For Pb Free Process

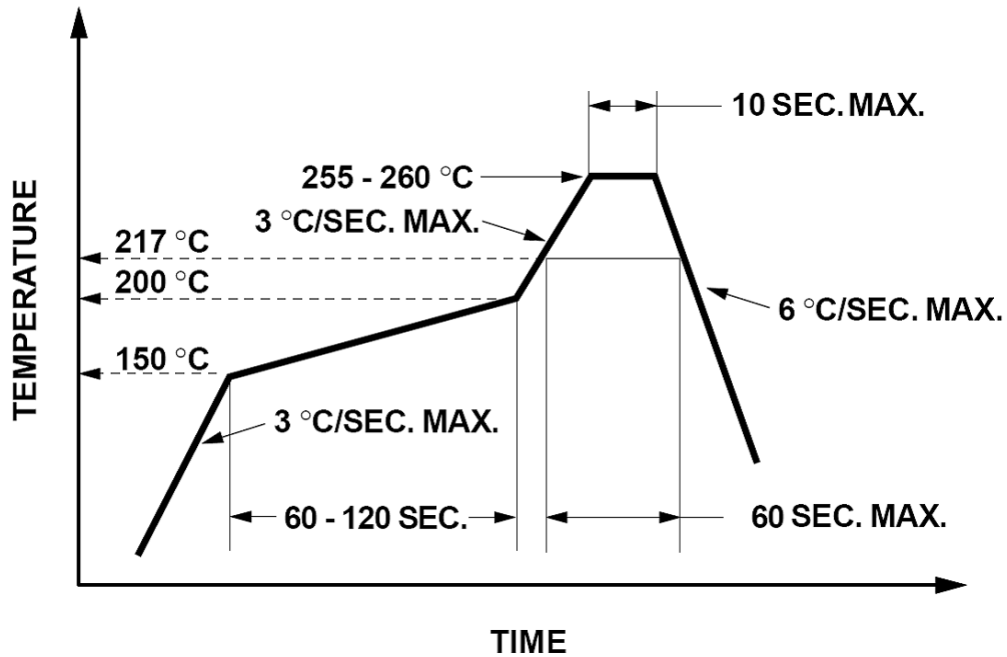



LITE-ON TECHNOLOGY CORPORATION.

Property of Lite-On Only

ELECTRICAL OPTICAL CHARACTERISTICS AT TA=25°C

PARAMETER	SYMBOL	MIN.	TYP.	MAX.	UNIT	TEST CONDITION
Radiant Intensity	I_E	0.8	1.4	-	mW/sr	$I_F = 20\text{mA}$
Peak Emission Wavelength	λ_{Peak}	-	940	-	nm	$I_F = 20\text{mA}$
Spectral Line Half-Width	$\Delta \lambda$	-	50	-	nm	$I_F = 20\text{mA}$
Forward Voltage	V_F	-	1.2	1.6	V	$I_F = 20\text{mA}$
Reverse Current	I_R	-	-	10	μA	$V_R = 5\text{V}$
Rise/Fall Time	T_r/T_f	-	500	-	nS	$I_F = 20\text{mA}$
Viewing Angle (See FIG.6)	$2\theta_{1/2}$	-	130	-	deg.	

TYPICAL ELECTRICAL / OPTICAL CHARACTERISTICS CURVES

(25°C Ambient Temperature Unless Otherwise Noted)

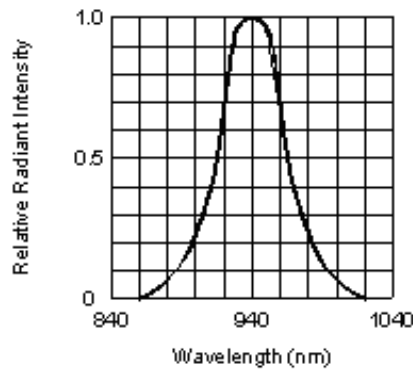

FIG.1 SPECTRAL DISTRIBUTION

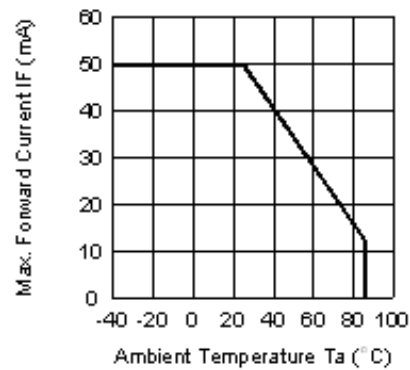

FIG.2 FORWARD CURRENT VS. AMBIENT TEMPERATURE

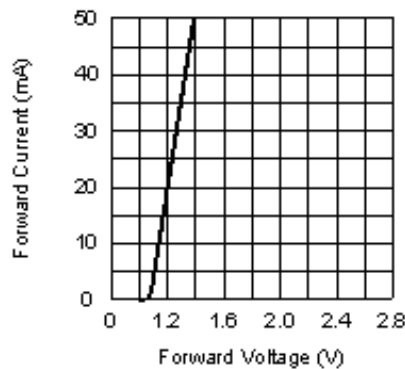

FIG.3 FORWARD CURRENT VS. FORWARD VOLTAGE

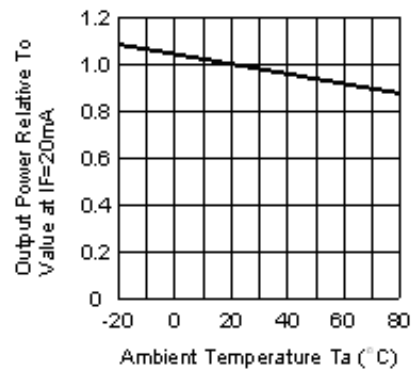

FIG.4 RELATIVE RADIANT INTENSITY VS. AMBIENT TEMPERATURE

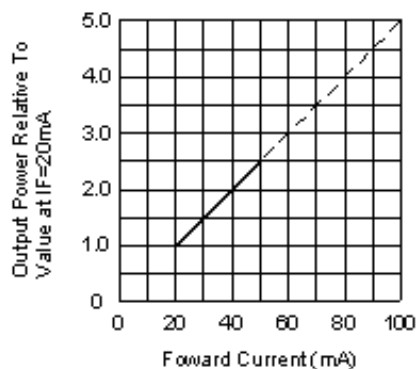

FIG.5 RELATIVE RADIANT INTENSITY VS. FORWARD CURRENT

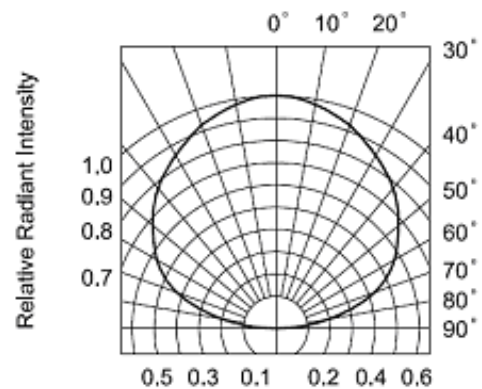
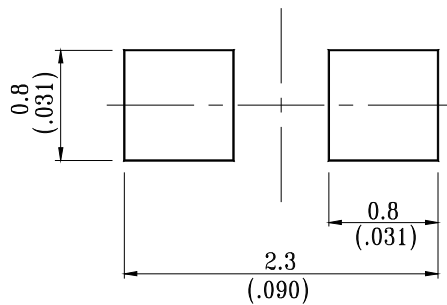

FIG.6 RADIATION DIAGRAM

Cleaning

Do not use unspecified chemical liquid to clean LED they could harm the package.
 If clean is necessary, immerse the LED in ethyl alcohol or in isopropyl alcohol at normal temperature for less one minute.

Suggest Soldering Pad Dimensions



Package Dimensions Of Tape And Reel

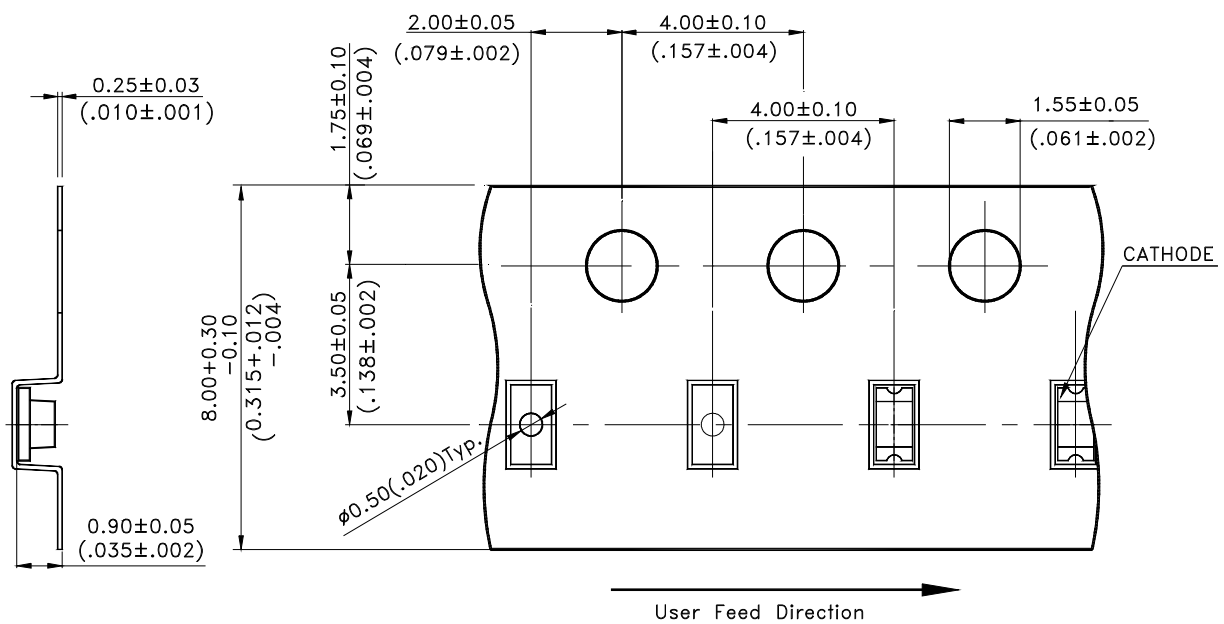

Notes:

1. All dimensions are in millimeters (inches).

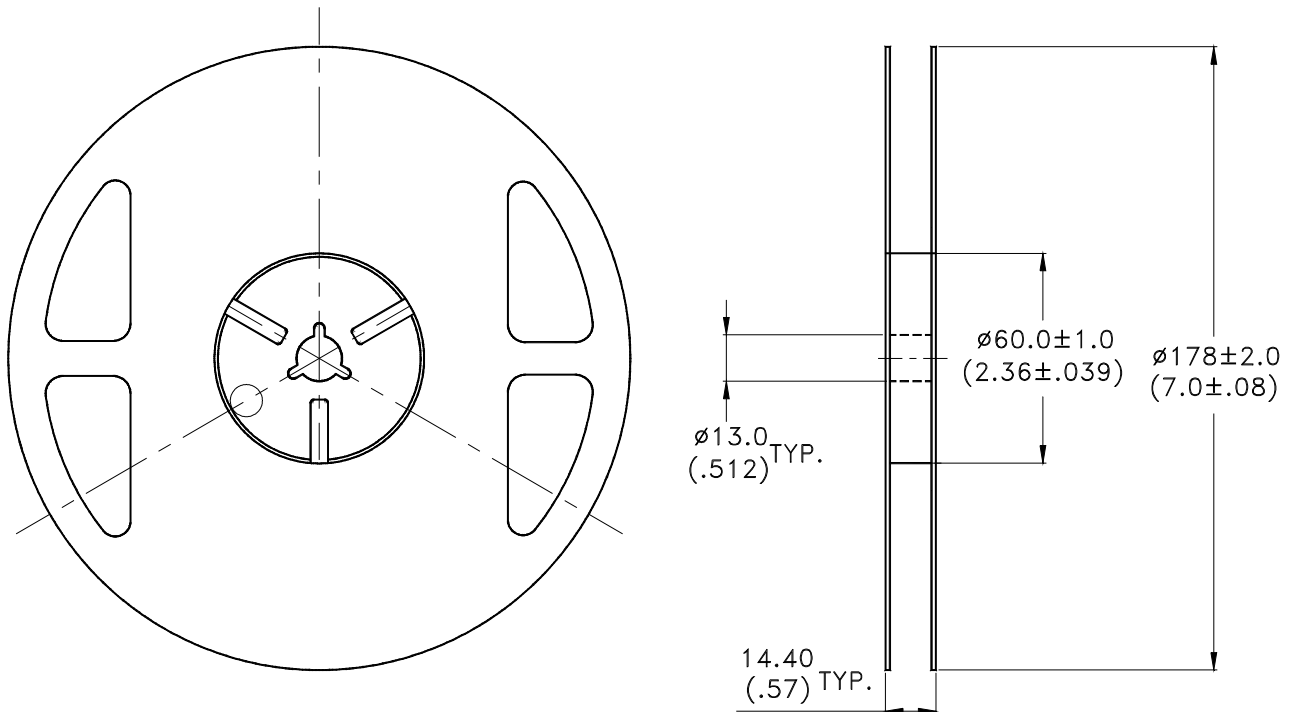
**Notes:**

1. All dimensions are in millimeters (inches).
2. Empty component pockets sealed with top cover tape.
3. 7 inch reel-3000 pieces per reel.
4. The maximum number of consecutive missing lamps is two.
5. In accordance with ANSI/EIA 481-1-A-1994 specifications.

CAUTIONS

1. Application

The LEDs described here are intended to be used for ordinary electronic equipment (such as office equipment, communication equipment and household applications). Consult Liteon's Sales in advance for information on applications in which exceptional reliability is required, particularly when the failure or malfunction of the LEDs may directly jeopardize life or health (such as in aviation, transportation, traffic control equipment, medical and life support systems and safety devices).

2. Storage

The package is sealed:

The LEDs should be stored at 30°C or less and 90%RH or less. And the LEDs are limited to use within one year, while the LEDs is packed in moisture-proof package with the desiccants inside.

The package is opened:

The storage ambient for the LEDs should not exceed 30°C temperature or 60% relative humidity.

It is recommended that LEDs out of their original packaging are IR-reflowed within one week hrs.

For extended storage out of their original packaging, it is recommended that the LEDs be stored in a sealed container with appropriate desiccant, or in a desiccators with nitrogen ambient.

LEDs stored out of their original packaging for more than one week hrs should be baked at about 60 deg C for at least 20 hours before solder assembly.

3. Cleaning

Use alcohol-based cleaning solvents such as isopropyl alcohol to clean the LED if necessary.

4. Soldering

Recommended soldering conditions:

Reflow soldering		Soldering iron	
Pre-heat	150~200°C	Temperature	300°C Max.
Pre-heat time	120 sec. Max.	Soldering time	3 sec. Max.
Peak temperature	260°C Max.		(one time only)
Soldering time	10 sec. Max.(Max. two times)		

Because different board designs use different number and types of devices, solder pastes, reflow ovens, and circuit boards, no single temperature profile works for all possible combinations.

However, you can successfully mount your packages to the PCB by following the proper guidelines and PCB-specific characterization.

LITE-ON Runs both component-level verification using in-house **KYRAMX98** reflow chambers and board-level assembly.

The results of this testing are verified through post-reflow reliability testing.

Profiles used at LITE-ON are based on JEDEC standards to ensure that all packages can be successfully and reliably surface mounted.

Figure on page3 shows a sample temperature profile compliant to JEDEC standards.

You can use this example as a generic target to set up your reflow process.

You should adhere to the JEDEC profile limits as well as specifications and recommendations from the solder paste manufacturer to avoid damaging the device and create a reliable solder joint.

5. Drive Method

An LED is a current-operated device. In order to ensure intensity uniformity on multiple LEDs connected in parallel in an application, it is recommended that a current limiting resistor be incorporated in the drive circuit, in series with each LED as shown in Circuit A below.

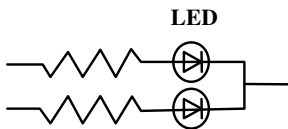
Circuit model A

(A) Recommended circuit.

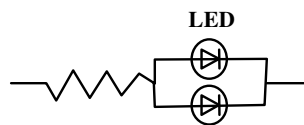
Circuit model B

(B) The brightness of each LED might appear different due to the differences in the I-V characteristics of those LEDs.