

## Performance Parameters

1MC04-018-XX/1

Type	$\Delta T_{\max}$ K	$Q_{\max}$ W	$I_{\max}$ A	$U_{\max}$ V	AC R Ohm	H mm
1MC04-018-xx/1 (N=18)						
1MC04-018-05/1	71	2.01	1.5	2.2	1.14	1.6
1MC04-018-08/1	72	1.29	0.9		1.80	1.9
1MC04-018-10/1	73	1.04	0.8		2.25	2.1
1MC04-018-12/1	73	0.88	0.6		2.69	2.3
1MC04-018-15/1	73	0.71	0.5		3.36	2.6

Performance data are given for 300K, vacuum

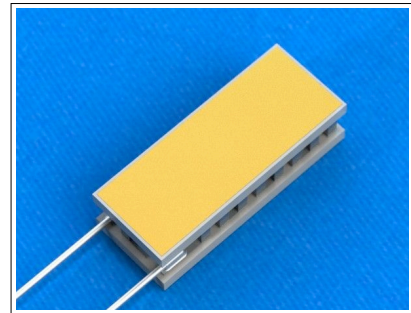

## Dimensions

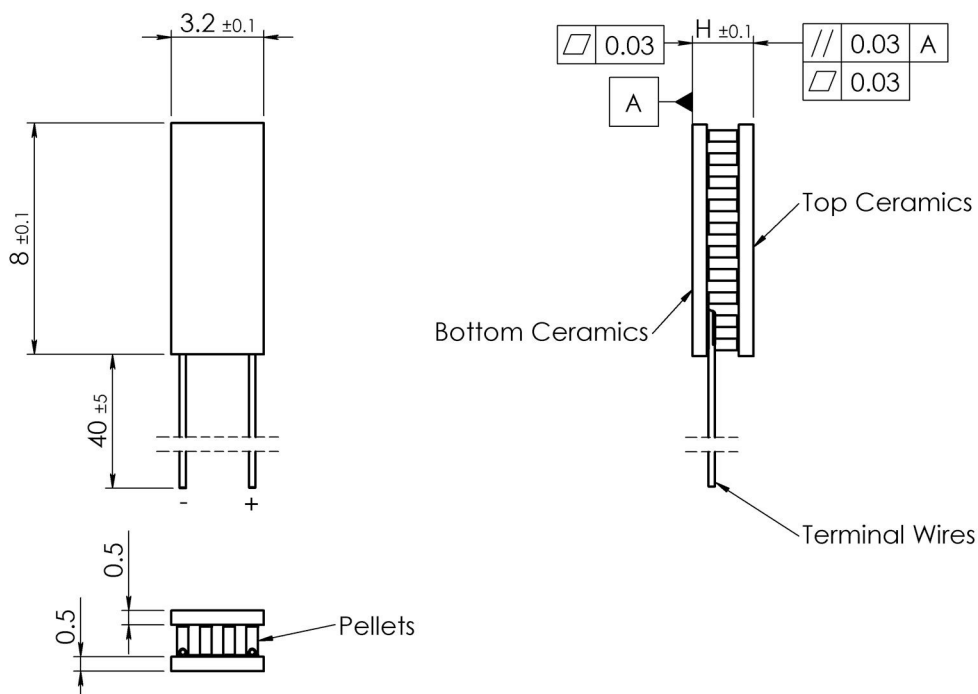

## Manufacturing options

**A. TEC Assembly:**

- \* 1. Solder SnSb ( $T_{\text{melt}}=230^{\circ}\text{C}$ )
- 2. Solder AuSn ( $T_{\text{melt}}=280^{\circ}\text{C}$ )

**B. Ceramics:**

- \* 1. Pure  $\text{Al}_2\text{O}_3$  (100%)
- 2. Alumina ( $\text{Al}_2\text{O}_3$ - 96%)
- 3. Aluminum Nitride (AlN)

\* - used by default

**C. Ceramics Surface Options:**

1. Blank ceramics (not metallized)
2. Metallized (Au plating)
3. Metallized and pre-tinned with:
  - 3.1 Solder 117 (In-Sn,  $T_{\text{melt}} = 117^{\circ}\text{C}$ )
  - 3.2 Solder 138 (Sn-Bi,  $T_{\text{melt}} = 138^{\circ}\text{C}$ )
  - 3.3 Solder 143 (In-Ag,  $T_{\text{melt}} = 143^{\circ}\text{C}$ )
  - 3.4 Solder 157 (In,  $T_{\text{melt}} = 157^{\circ}\text{C}$ )
  - 3.5 Solder 183 (Pb-Sn,  $T_{\text{melt}} = 183^{\circ}\text{C}$ )
  - 3.6 Optional (specified by Customer)

**D. Thermistor (optional)**

Can be mounted to cold side ceramics edge. Calibration is available by request.

**E. Terminal contacts**

1. Blank, tinned Copper
2. Insulated Wires
3. Insulated, color coded

## Performance Data

1MC04-018-05/1

@ 27°C, Vacuum	$\Delta T_{max}$ K	$Q_{max}$ W	$I_{max}$ A	$U_{max}$ V
1MC04-018-05/1	71	2.01	1.5	2.2

@50°C, N2	$\Delta T_{max}$ K	$Q_{max}$ W	$I_{max}$ A	$U_{max}$ V
1MC04-018-05/1	74	2.19	1.5	2.5

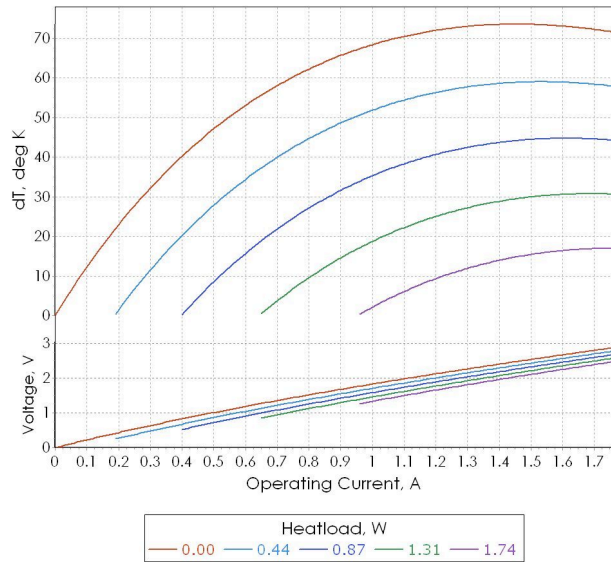
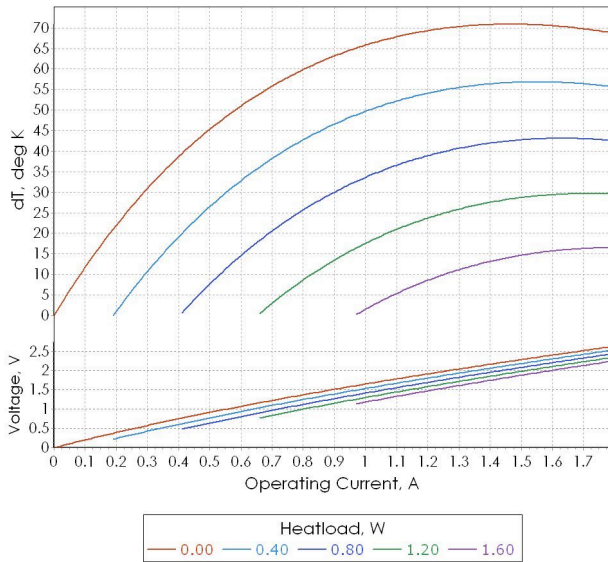

**Note:** Performance data is specified for optimal optimal conditions (TEC hot side is stabilized at ambient temperature). Heatsink thermal resistance is not included into estimations. Use TECCad Software for estimations under different conditions.

## Performance Data

1MC04-018-08/1

@ 27°C, Vacuum	$\Delta T_{max}$ K	$Q_{max}$ W	$I_{max}$ A	$U_{max}$ V
1MC04-018-08/1	72	1.29	0.9	2.2

@50°C, N2	$\Delta T_{max}$ K	$Q_{max}$ W	$I_{max}$ A	$U_{max}$ V
1MC04-018-08/1	74	1.41	0.9	2.5

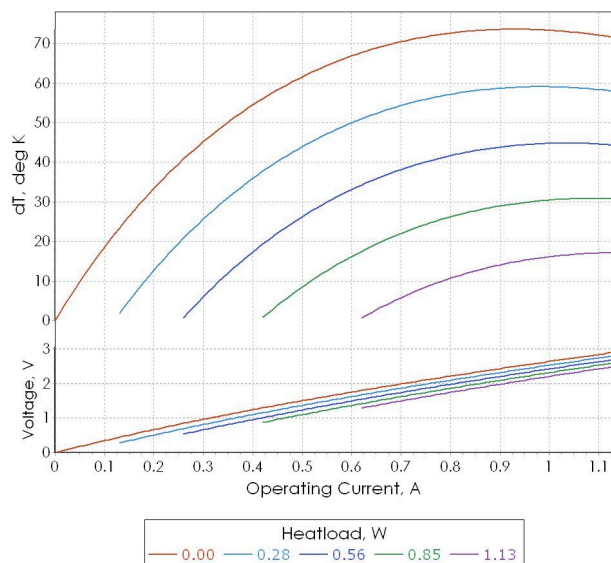
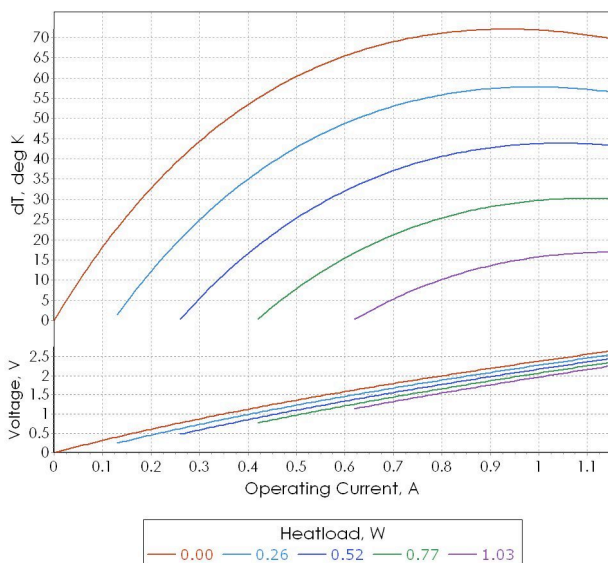

**Note:** Performance data is specified at optimal optimal conditions (TEC hot side is stabilized at ambient temperature). Any heatsink thermal resistance is not included into estimations. Use TECCad Software for estimations under different conditions.

### Performance Data

1MC04-018-10/1

@ 27°C, Vacuum	$\Delta T_{max}$ K	$Q_{max}$ W	$I_{max}$ A	$U_{max}$ V
1MC04-018-10/1	73	1.04	0.8	2.3

@50°C, N2	$\Delta T_{max}$ K	$Q_{max}$ W	$I_{max}$ A	$U_{max}$ V
1MC04-018-10/1	74	1.14	0.8	2.5

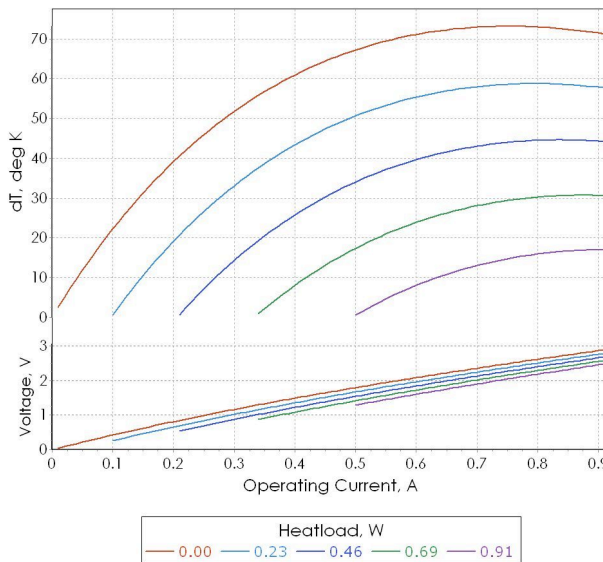
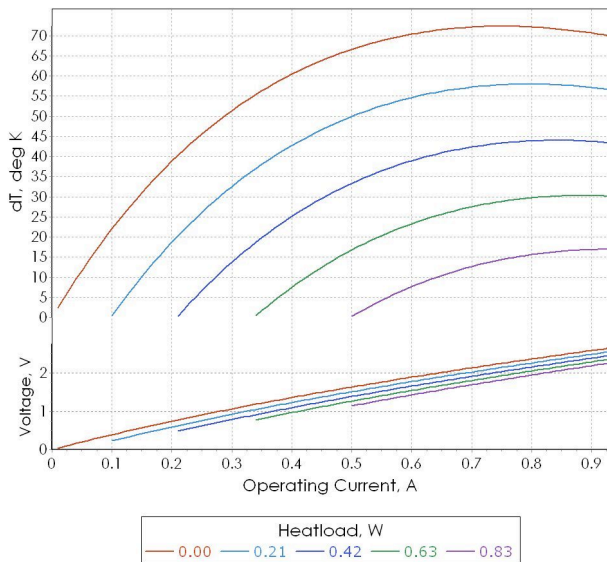

**Note:** Performance data is specified for optimal optimal conditions (TEC hot side is stabilized at ambient temperature). Heatsink thermal resistance is not included into estimations. Use TECCad Software for estimations under different conditions.

### Performance Data

1MC04-018-12/1

@ 27°C, Vacuum	$\Delta T_{max}$ K	$Q_{max}$ W	$I_{max}$ A	$U_{max}$ V
1MC04-018-12/1	73	0.88	0.6	2.3

@50°C, N2	$\Delta T_{max}$ K	$Q_{max}$ W	$I_{max}$ A	$U_{max}$ V
1MC04-018-12/1	73	0.96	0.6	2.5

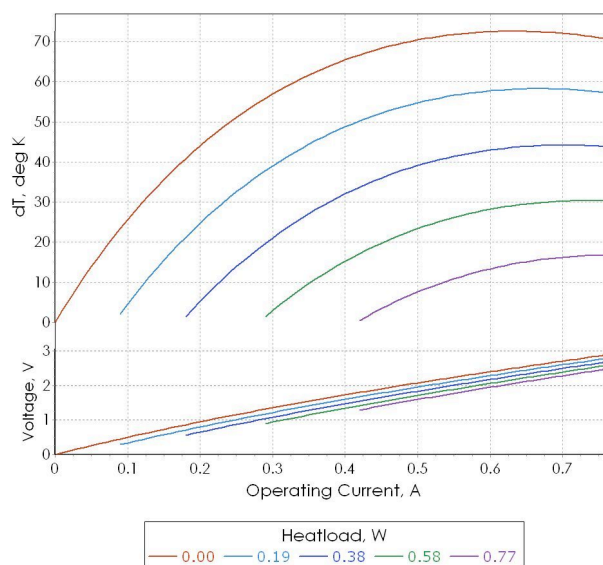
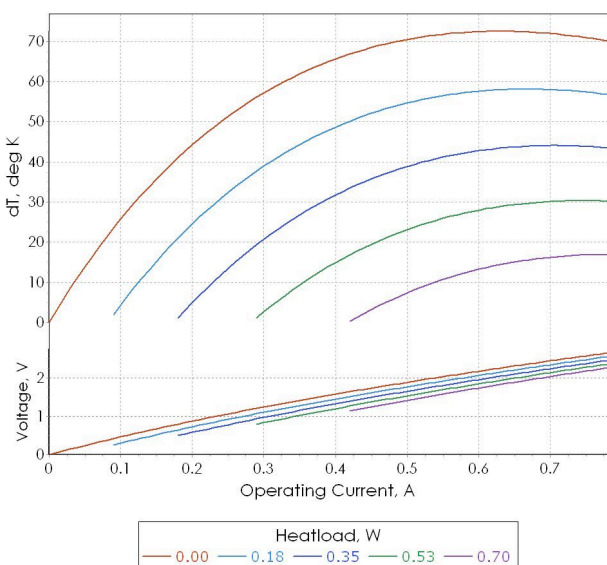

**Note:** Performance data is specified for optimal optimal conditions (TEC hot side is stabilized at ambient temperature). Heatsink thermal resistance is not included into estimations. Use TECCad Software for estimations under different conditions.

## Performance Data

1MC04-018-15/1

@ 27°C, Vacuum	$\Delta T_{max}$ K	$Q_{max}$ W	$I_{max}$ A	$U_{max}$ V
1MC04-018-15/1	73	0.71	0.5	2.3

@50°C, N2	$\Delta T_{max}$ K	$Q_{max}$ W	$I_{max}$ A	$U_{max}$ V
1MC04-018-15/1	72	0.78	0.5	2.5

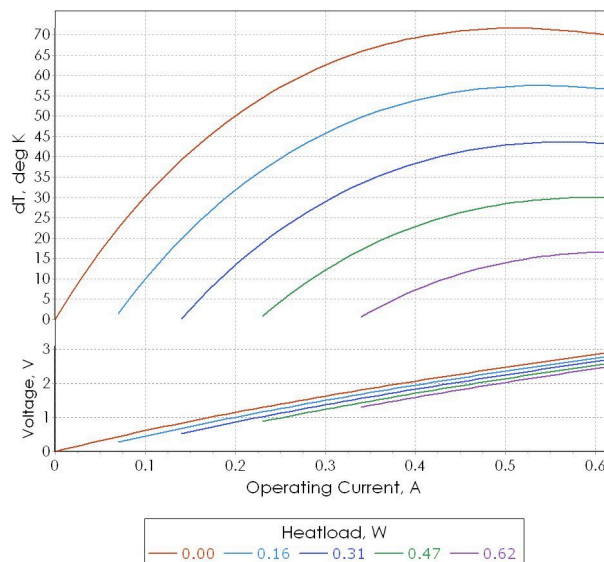
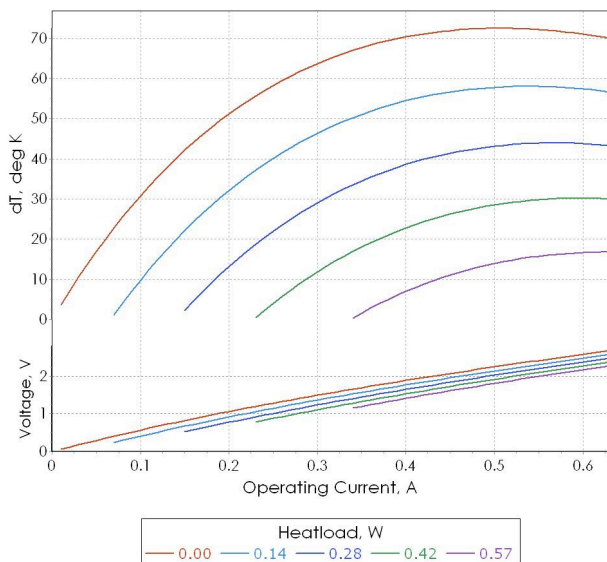

**Note:** Performance data is specified for optimal conditions (TEC hot side is stabilized at ambient temperature). Heatsink thermal resistance is not included into estimations. Use TECCad Software for estimations under different conditions.

## Important notes

1. TEC Performance in this datasheet is specified in two standard ambient condition modes (vacuum, +27°C and dry nitrogen (N<sub>2</sub>), +50°C). The performance may differ under other conditions. Please, use TECCad software from RMT Ltd web site or contact RMT or its branch specialists directly for additional TEC performance info.
2. TEC ACR and  $U_{max}$  values are sensitive to ambient temperature. These values can be different from those specified in the datasheet at other ambient conditions. ACR and  $U_{max}$  raise with ambient temperature increasing.
3. TEC cooling capacity ( $Q_{max}$ ) raises with ambient temperature. Please, use TECCad software for additional info or contact RMT specialists directly.
4. Thermolectric coolers have the best performance in the temperature range from near room up to +80..90°C. The performance is lower at temperatures below 0°C. TEC is not suitable to work at cryogenic temperatures.
5. Driving a TEC at  $I_{max}$  or  $U_{max}$  doesn't mean max performance mode. The real optimal mode may depend on operating conditions and heatload. In fact a better performance can be reached at operating current and voltage lower than  $I_{max}$  and  $U_{max}$  values specified in the datasheet.
6. It is strongly recommended to avoid a direct mounting of thermolectric cooler to pure Copper, Aluminum or Nickel materials as well as a mounting of objects from these materials on TEC cold side. Any material with high CTE may affect TEC lifetime and/or damage it in case of improper mounting, thermal shock or temperature cycling. In case of above mentioned materials necessity, it is recommended to use soft solders or glues with large modulus of elasticity (Indium-based solders or silicon-based thermoconductive glues).
7. RMT Ltd confirms that all thermolectric coolers meet the requirements of Telcordia GR-468 standard. The up-to-date Reliability Report is available by request. RMT Ltd warranties thermolectric coolers lifetime no less than 250K-300K operating hours under normal application conditions.



## Additional Options

### TEC Polarity

TEC Polarity can be modified by request. The specified polarity in this datasheet is typical. It can be reversed in accordance to Customer application requirements.

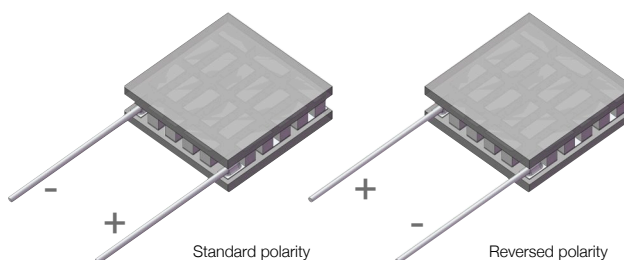

### Terminal Wires Options

The wires are of tinned Copper, blank (not isolated) by default. Various options for isolated wires are available by request. The available solutions include isolated wires, isolated color-coded wires, flexible multicore wires and more.

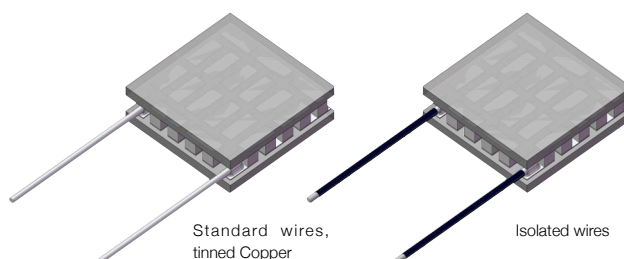

### Customized Au Patterns

Customized Au patterns on thermoelectric cooler cold side are available by request. Selective Pre-tinning over pattern is also available. Please, contact RMT Ltd for additional information about customized Au patterns requirements.

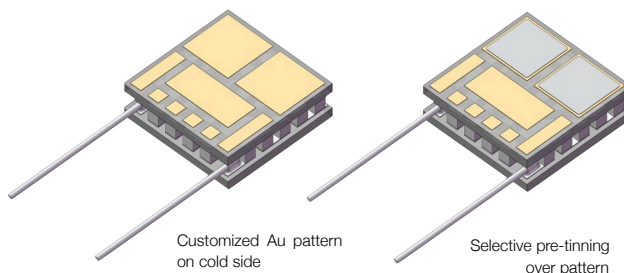

### TEC Height modification

Standard TEC height can be modified without performance changes by using ceramics of different thickness. Standard thermoelectric cooler height (specified in the datasheet) may be modified in a range -0.5..+1.0mm for single-stage TEC by request.

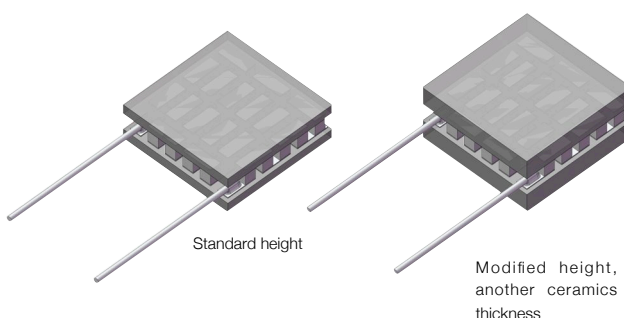

## Thermoelectric Cooler Overview

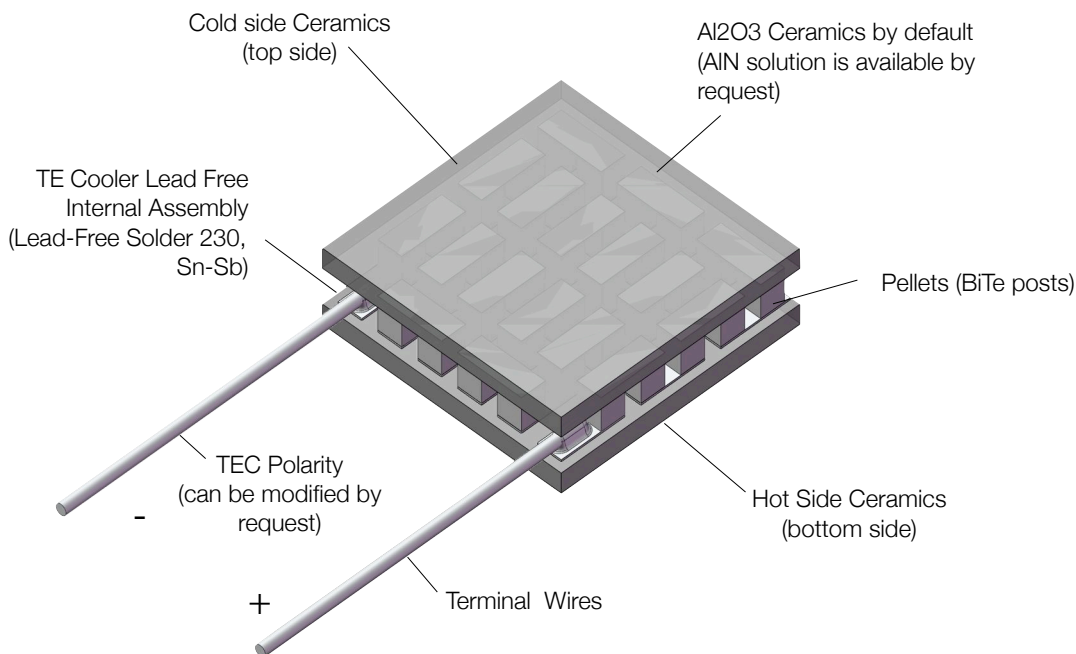

## Application Tips

- |   |   |
|---|---|
| <ol style="list-style-type: none"> <li>1. Never heat TE module more than 200°C (TEC assembled at 230°C).</li> <li>2. Never use TE module without an attached heat sink at hot (bottom) side.</li> </ol> | <ol style="list-style-type: none"> <li>1. Connect TE module to DC power supply according to polarity.</li> <li>2. Do not apply DC current higher than I<sub>max</sub>.</li> </ol> |
|---|---|

## Installation

1. **Mechanical Mounting.** TEC is placed between two heat exchangers. This construction is fixed by screws or in another mechanical way. It is suitable for large modules (with dimensions 30x30mm and larger). Miniature types require other assembling methods in most cases.
1. **Soldering.** This method is suitable for a TE module with metallized outside surfaces. RMT provides this option and also makes pre-tinning for TE modules.
2. **Gluing.** It is an up-to-date method that is used by many customers due to availability of glues with good thermoconductive properties. A glue is usually based on some epoxy compound filled with some thermoconductive material such as graphite or diamond powders, silver, SiN and others. The application of a specific type depends on application features and the type of a TE module.

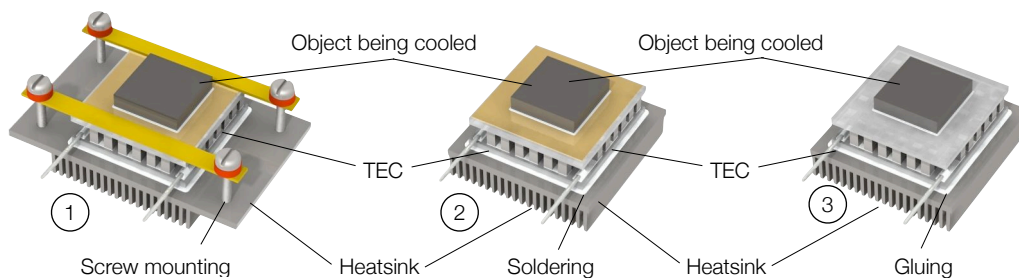

## Contacts

### **RMT Ltd. Headquarters**

Warshavskoe sh. 46, 115230, Moscow

Russia

Phone: +7-499-678-2082

Fax: +7-499-678-2083

Web: [www.rmtltd.ru](http://www.rmtltd.ru)

Email: [info@rmtltd.ru](mailto:info@rmtltd.ru)

### **EUROPE/USA - TEC Microsystems GmbH**

Schwarzschildstrasse 3, 12489 Berlin

Germany

Tel. +49 30 6789 3314

Fax+49 30 6789 3315

Web: [www.tec-microsystems.com](http://www.tec-microsystems.com)

Email: [info@tec-microsystems.com](mailto:info@tec-microsystems.com)

### **CHINA - ProTEC Ltd.**

深圳市南山区登良路恒裕中心B座207

电话：+86-755-61596066

传真：+86-755-61596036

邮编：518054

Web: [www.protecltd.com](http://www.protecltd.com)

Email: [info@protecltd.com](mailto:info@protecltd.com)

## Legal Notice

All logos, images, trademarks and product names (collectively Materials) are proprietary to RMT Ltd and/ or any of its affiliates, or subsidiaries, or other respective owners that have granted RMT Ltd the permission and/or license to use such Materials. All images are provided by RMT Ltd. and are subjects of copyright protection.

RMT Ltd, TEC Microsystems GmbH and ProTEC Ltd do not grant a copyright license (express or implied) to the Recipient, except that Recipient may reproduce the logos, images and text materials in this press-release without any alteration for non-promotional or editorial purposes only with a written note about materials owner.

## Copyright protection warning

Graphic materials and text from this datasheet may not be used commercially without a prior response in writing on company letterhead and signed by RMT Ltd authority. Thank you for respecting the intellectual property rights protected by the International Copyright laws.

**Warning:** All datasheet images contain RMT Ltd hidden watermark for the immediate proof of their origin.

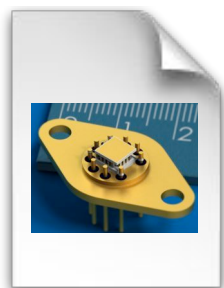

RMT Image

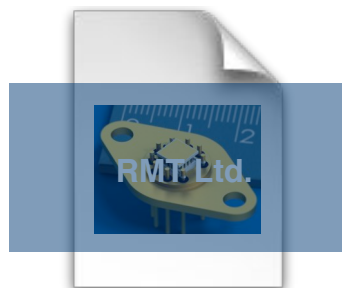

Hidden Watermark