

661/662/663/664 SERIES



D-Sub Connectors: Dual Port, Right Angle

Features:

- Two contact rows per connector with right angle bend
- 0.109" (2.77mm) contact spacing x 0.112" (2.84mm) row spacing
- Plug and receptacle in 9, 15, 25 or 37 contact sizes
- Pin and socket contact mating design with P.C. tail termination
- Metal shell provides EMI/RFI shielding, plug shell indents provide grounding and additional mating retention
- Board mounting features include grounding bracket with threaded hole or boardlocks for exceptional retention to P.C. board
- Flange mounting options for panel mount or connector mating include through hole, threaded inserts and threaded standoffs
- D-shaped connector mating outline provides polarization
- Design based on requirements of MIL-C-24038, EIA RS-232 and RS-449
- Additional grounding features or mounting options - contact customer service at customerservice@edac.net



Specifications:

Insulator Material	Thermoplastic Polyester, UL 94V-0, Chemical Resistant, Color: Black
Contact Material	Plug (Pins): Brass Receptacle (Socket): Brass or Phosphor Bronze
Contact Plating	Selective Gold (See Ordering Code) over Nickel for the Mating Area, Tin Plating for Tail Area
Ferrite Specs:	20dB MIN @30 MHz, 30dB MIN @50 MHz, and 50dB MIN @100 MHz (Optional)
Shell Material	Nickel Plated Steel
Current Rating	3 amps
Contact Resistance	25 Milliohms maximum
Insulation Resistance	5000 megaohms minimum
Dielectric Withstanding Voltage	1000 V AC rms at Sea Level
Operating Temperature	-55°C To +85°C
Insertion Force	16 oz (4.45 N) Maximum Per Contact Position

Ordering Code:

661-025-264-053

SERIES: _____
 661: PLUG OVER PLUG
 662: RECEPTACLE OVER RECEPTACLE
 663: PLUG OVER RECEPTACLE
 664: RECEPTACLE OVER PLUG

NO. OF CONTACTS (PER CONNECTOR): _____
 009 - 9 CONTACTS 025 - 25 CONTACTS
 015 - 15 CONTACTS 037 - 37 CONTACTS

CONTACT FINISH CODE: _____
 2 - GOLD FLASH PLATING
 3 - 15 MICROINCHES OF GOLD PLATING
 6 - 30 MICROINCHES OF GOLD PLATING

CONTACT CODE: _____
 64 - DUAL PORT RIGHT ANGLE BEND CONTACT

EDAC INTERNAL: _____
 0

FLANGE MOUNTING OPTIONS:
 1 - .625" (15.88MM) M3 THREADED INSERT
 2 - .625" (15.88MM) #4-40 UNC THREADED INSERT
 3 - .625" (15.88MM) #4-40 UNC THREADED HEX STANDOFF
 4 - .625" (15.88MM) .125" CLEAR HOLE INSERT
 A - .750" (19.05MM) M3 THREADED INSERT
 5 - .750" (19.05MM) #4-40 UNC THREADED INSERT
 6 - .750" (19.05MM) #4-40 UNC THREADED HEX STANDOFF
 7 - .750" (19.05MM) .125" CLEAR HOLE INSERT
 C - .900" (22.86MM) M3 THREADED INSERT
 8 - .900" (22.86MM) #4-40 UNC THREADED INSERT
 9 - .900" (22.86MM) #4-40 UNC THREADED HEX STANDOFF
 0 - .900" (22.86MM) .125" CLEAR HOLE INSERT

BOARD GROUNDING FEATURE:
 0 - Ø3.80mm THRU' HOLES
 3 - 4x 2 PRONG BOARDLOCKS
 4 - 2x 2 PRONG BOARDLOCKS (REAR ONLY)
 5 - #4-40 THREADED HOLE

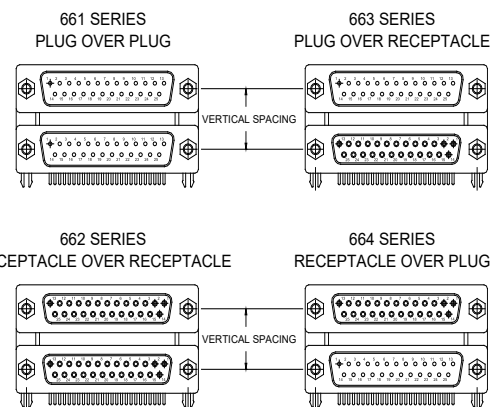

D-Sub Connectors: Dual Port, Right Angle

PLUG/PLUG 661 SERIES

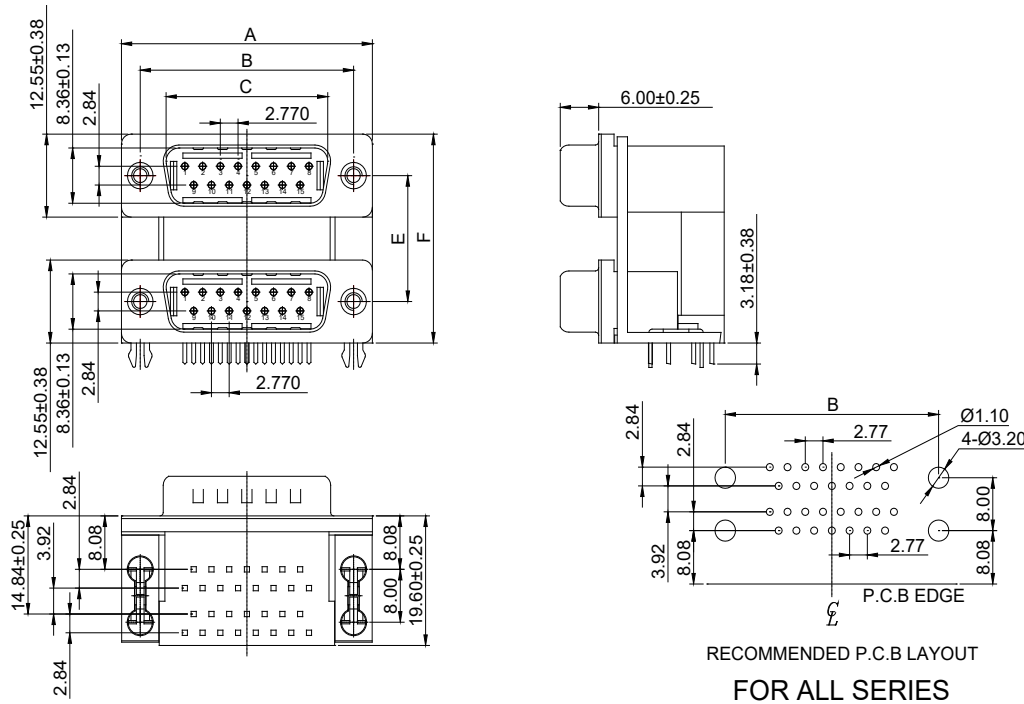

RECEPTACLE/RECEPTACLE 662 SERIES

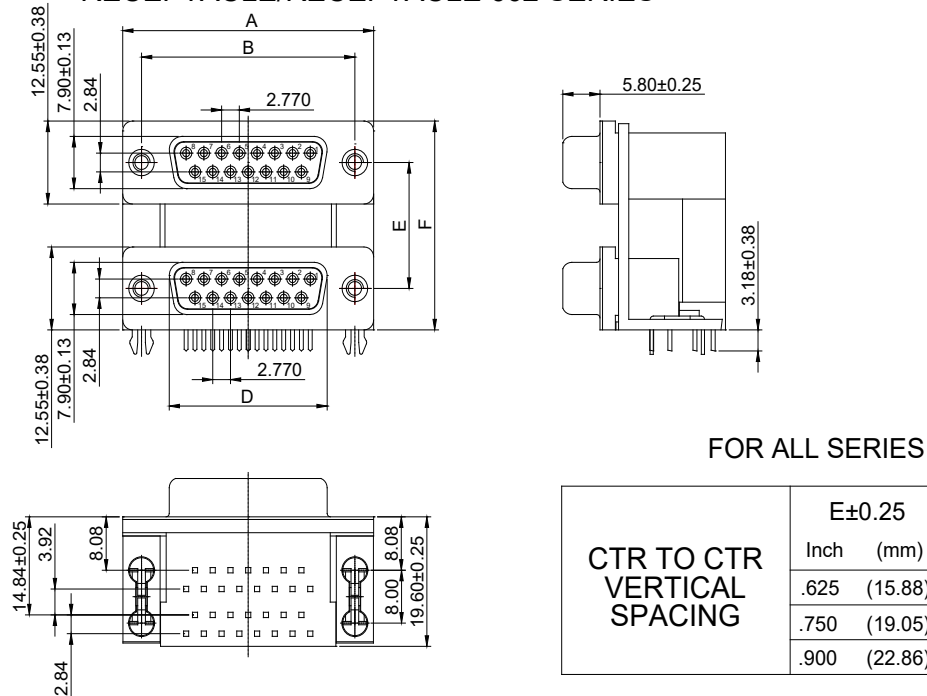

FOR ALL SERIES

NUMBER OF CONTACTS	A ± 0.38		B ± 0.25		C ± 0.13 PLUG		D ± 0.13 RECEPTACLE	
	Inch	(mm)	Inch	(mm)	Inch	(mm)	Inch	(mm)
9	1.213	(30.81)	.984	(24.99)	.666	(16.92)	.643	(16.33)
15	1.543	(39.19)	1.312	(33.32)	.994	(25.25)	.971	(24.66)
25	2.088	(53.04)	1.852	(47.04)	1.534	(38.96)	1.511	(38.38)
37	2.729	(69.32)	2.500	(63.50)	2.182	(55.42)	2.159	(54.84)

D-Sub Connectors: Dual Port, Right Angle

PLUG/RECEPTACLE 663 SERIES

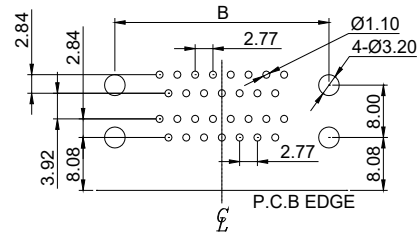
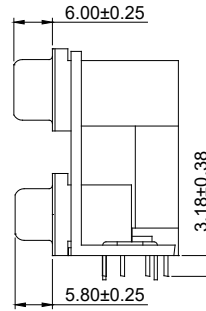
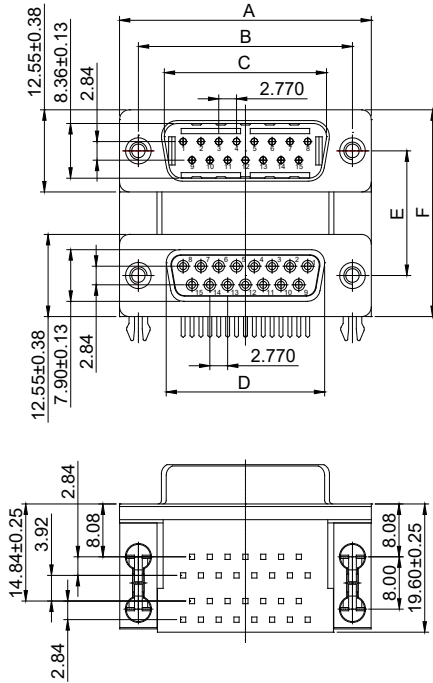

RECOMMENDED P.C.B LAYOUT
FOR ALL SERIES

RECEPTACLE/PLUG 664 SERIES

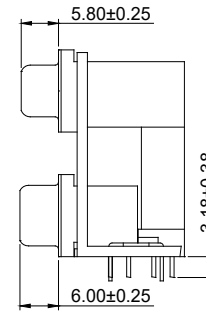
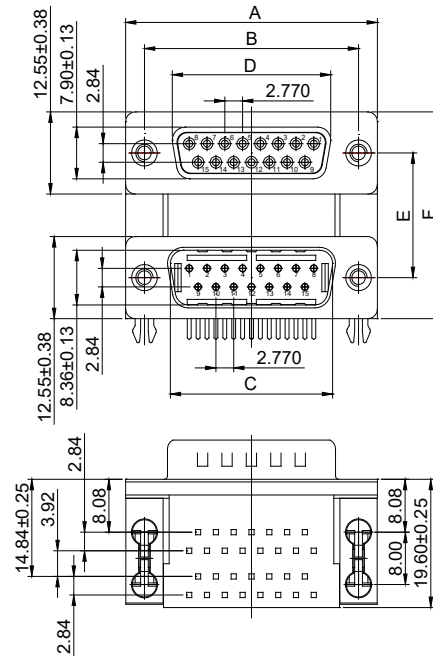

FOR ALL SERIES

CTR TO CTR VERTICAL SPACING	E±0.25		F±0.38	
	Inch	(mm)	Inch	(mm)
.625	.625	(15.88)	1.119	(28.43)
.750	.750	(19.05)	1.244	(31.60)
.900	.900	(22.86)	1.394	(35.41)

FOR ALL SERIES

NUMBER OF CONTACTS	A±0.38		B±0.25		C±0.13 PLUG		D±0.13 RECEPTACLE	
	Inch	(mm)	Inch	(mm)	Inch	(mm)	Inch	(mm)
9	1.213	(30.81)	.984	(24.99)	.666	(16.92)	.643	(16.33)
15	1.543	(39.19)	1.312	(33.32)	.994	(25.25)	.971	(24.66)
25	2.088	(53.04)	1.852	(47.04)	1.534	(38.96)	1.511	(38.38)
37	2.729	(69.32)	2.500	(63.50)	2.182	(55.42)	2.159	(54.84)