



# LARA-R6 series

Single or multi-mode LTE Cat 1 modules with Secure Cloud  
Data sheet



## Abstract

The LARA-R6 cellular module features uncompromised global connectivity in a very small form factor. With global, multi-regional and regional variants, customers have great flexibility and can simplify their logistics. The feature-rich LARA-R6 is secure by design and has a comprehensive certification scheme, versatile interfaces, and multi-band and multi-mode capabilities, all which make LARA-R6 ideally suited for use in any region and in wide range of applications.

# Document information

<b>Title</b>	<b>LARA-R6 series</b>	
<b>Subtitle</b>	Single or multi-mode LTE Cat 1 modules with Secure Cloud	
<b>Document type</b>	Data sheet	
<b>Document number</b>	UBX-21004391	
<b>Revision and date</b>	R09	18-Aug-2022
<b>Disclosure restriction</b>	C1-Public	

<b>Product status</b>	<b>Corresponding content status</b>	
<b>Functional sample</b>	Draft	For functional testing. Revised and supplementary data will be published later.
<b>In development / Prototype</b>	Objective specification	Target values. Revised and supplementary data will be published later.
<b>Engineering sample</b>	Advance information	Data based on early testing. Revised and supplementary data will be published later.
<b>Initial production</b>	Early production information	Data from product verification. Revised and supplementary data may be published later.
<b>Mass production / End of life</b>	Production information	Document contains the final product specification.

This document applies to the following products:

<b>Product name</b>	<b>Type number</b>	<b>Modem version</b>	<b>Application version</b>	<b>PCN reference</b>	<b>Product status</b>
LARA-R6001	LARA-R6001-00B-00	02.14	A00.01	UBX-22019779	Initial production
LARA-R6001D	LARA-R6001D-00B-00	00.13	A00.01	UBX-22008409	Initial production
LARA-R6401	LARA-R6401-00B-00	02.14	A00.01	UBX-22019779	Initial production
LARA-R6401D	LARA-R6401D-00B-00	01.14	A00.01	UBX-22014149	Initial production
LARA-R6801	LARA-R6801-00B-00	02.14	A00.01	UBX-22019779	Initial production

u-blox or third parties may hold intellectual property rights in the products, names, logos and designs included in this document. Copying, reproduction, modification or disclosure to third parties of this document or any part thereof is only permitted with the express written permission of u-blox.

The information contained herein is provided "as is" and u-blox assumes no liability for its use. No warranty, either express or implied, is given, including but not limited to, with respect to the accuracy, correctness, reliability and fitness for a particular purpose of the information. This document may be revised by u-blox at any time without notice. For the most recent documents, visit [www.u-blox.com](http://www.u-blox.com).

Copyright © u-blox AG.

# Contents

<b>Document information</b> .....	<b>2</b>
<b>Contents</b> .....	<b>3</b>
<b>1 Functional description</b> .....	<b>5</b>
1.1 Overview.....	5
1.2 Product features .....	5
1.3 Block diagram .....	6
1.4 Product description .....	6
1.5 AT command support .....	8
1.6 Supported features .....	8
<b>2 Interfaces</b> .....	<b>11</b>
2.1 Power management .....	11
2.1.1 Module supply input (VCC) .....	11
2.1.2 Generic digital interfaces supply output (V_INT) .....	11
2.2 Antenna interfaces.....	11
2.2.1 Antenna RF interfaces.....	11
2.2.2 Antenna detection.....	11
2.3 System functions.....	11
2.3.1 Module power-on .....	11
2.3.2 Module power-off.....	12
2.3.3 Module reset .....	12
2.4 SIM interface.....	12
2.4.1 SIM card / chip interface .....	12
2.4.2 SIM card detection .....	13
2.5 Serial communication .....	13
2.5.1 UART interfaces.....	13
2.5.2 USB interface.....	14
2.5.3 I2C interface.....	14
2.6 Audio interface .....	15
2.7 Clock output .....	15
2.8 GPIO pins.....	15
2.9 Antenna dynamic tuner interface.....	16
2.10 Reserved pins.....	16
<b>3 Pin definition</b> .....	<b>17</b>
3.1 Pin assignment.....	17
<b>4 Electrical specifications</b> .....	<b>21</b>
4.1 Absolute maximum rating.....	21
4.1.1 Maximum ESD.....	21
4.2 Operating conditions .....	22
4.2.1 Operating temperature range.....	22
4.2.2 Thermal parameters .....	22

4.2.3	Supply/power pins .....	22
4.2.4	Current consumption .....	23
4.2.5	LTE RF characteristics .....	24
4.2.6	3G RF characteristics .....	26
4.2.7	2G RF characteristics .....	27
4.2.8	ANT_DET pin.....	27
4.2.9	PWR_ON pin.....	27
4.2.10	RESET_N pin.....	28
4.2.11	SIM pins .....	28
4.2.12	USB pins .....	28
4.2.13	I2C pins .....	29
4.2.14	Generic Digital Interfaces pins .....	29
4.2.15	Smart temperature supervisor .....	30
4.3	Parameters for ATEX applications .....	30
<b>5</b>	<b>Mechanical specifications .....</b>	<b>32</b>
<b>6</b>	<b>Qualification and approvals.....</b>	<b>33</b>
6.1	Reliability tests .....	33
6.2	Approvals.....	33
<b>7</b>	<b>Product handling &amp; soldering.....</b>	<b>34</b>
7.1	Packaging .....	34
7.1.1	Reels .....	34
7.1.2	Tapes.....	34
7.2	Moisture sensitivity levels.....	35
7.3	Reflow soldering .....	35
7.4	ESD precautions.....	35
<b>8</b>	<b>Labeling and ordering information .....</b>	<b>36</b>
8.1	Product labeling.....	36
8.2	Explanation of codes .....	36
8.3	Ordering information.....	37
<b>Appendix</b>	<b>.....</b>	<b>38</b>
<b>A</b>	<b>Glossary .....</b>	<b>38</b>
<b>Related documentation</b>	<b>.....</b>	<b>40</b>
<b>Revision history</b>	<b>.....</b>	<b>41</b>
<b>Contact</b> .....	<b>.....</b>	<b>41</b>



The LARA-R6001D and the LARA-R6401D data-only product versions have the same electrical characteristics, feature set, and functionalities of LARA-R6001 and LARA-R6401 data and voice product versions respectively, except for the support of voice / audio. Unless otherwise specified, herein “LARA-R6001” refers to both LARA-R6001 and LARA-R6001D product versions and “LARA-R6401” refers to both LARA-R6401 and LARA-R6401D product versions.

### 1.3 Block diagram

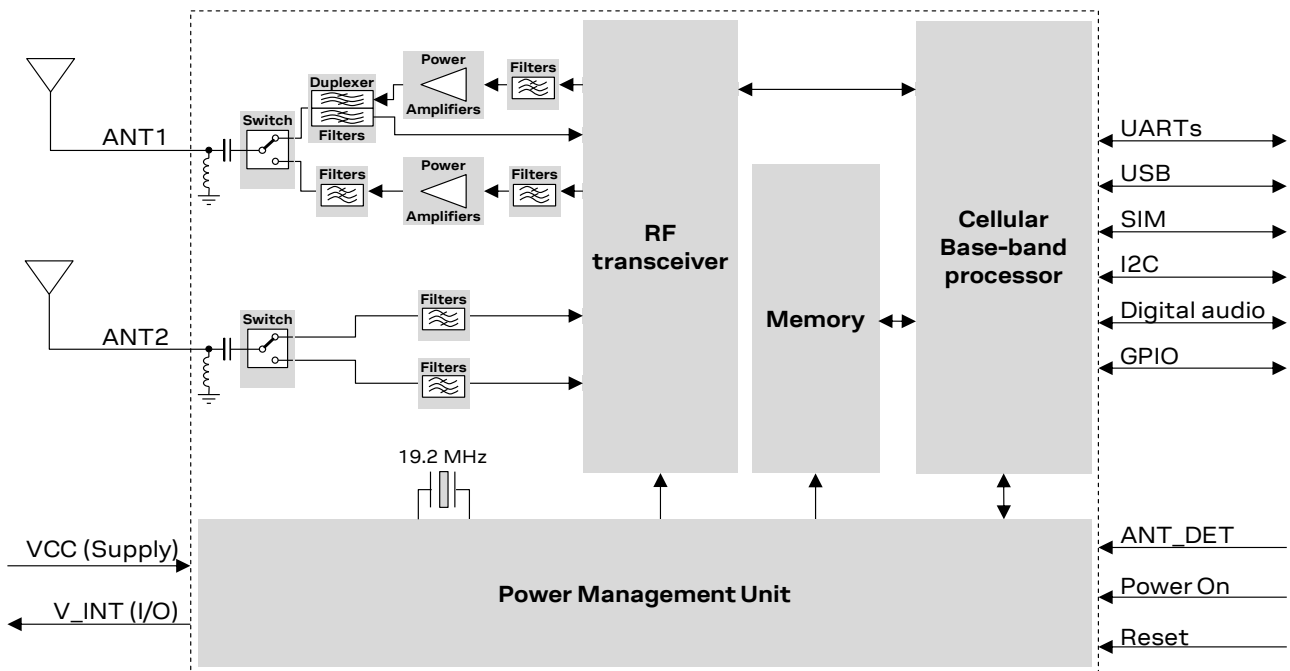

Figure 1: LARA-R6 series block diagram

### 1.4 Product description

LARA-R6 series modules include five variants providing flexibility to use the bands and the radio access technology available in specific region or with specific operators:

- LARA-R6001 / LARA-R6001D are the smallest LTE Cat 1 multi-mode modules for global coverage. Its single SKU for the world provides universal connectivity and simplifies logistics. This truly global module with comprehensive band support has 18 LTE bands plus 3G/2G fallback.
- LARA-R6401 / LARA-R6401D modules offer an ideal LTE Cat 1 solution for North America, supporting all relevant LTE bands. They are designed for use on AT&T, FirstNet, Verizon, or T-Mobile. Managing a single SKU for the North American market simplifies logistics and reduces related costs.
- LARA-R6801 is a multi-regional variant specifically designed for use in EMEA/APAC/Japan and Latin America regions. It supports all relevant LTE Cat 1 bands plus 3G/2G fallback.

Except for the LARA-R6001D and LARA-R6401D data-only product versions, the LARA-R6 series modules provide Voice over LTE (VoLTE) and Circuit-Switched-Fall-Back (CSFB) audio capability according to the supported Radio Access Technology. The 911 and E911 services are not supported.

Module	Region	LTE FDD bands <sup>1</sup>	LTE TDD bands <sup>1</sup>	WCDMA bands	GSM bands
LARA-R6001	Global	12 (700 MHz)	39 (1900 MHz)	5 (850 MHz)	GSM 850
		28 (700 MHz)	40 (2300 MHz)	8 (900 MHz)	E-GSM 900
		13 (700 MHz)	41 (2600 MHz)	2 (1900 MHz)	DCS 1800
		20 (800 MHz)	38 (2600 MHz)	1 (2100 MHz)	PCS 1900
		18 (850 MHz)			
		19 (850 MHz)			
		26 (850 MHz)			
		5 (850 MHz)			
		8 (900 MHz)			
		4 (1700 MHz)			
		3 (1800 MHz)			
		2 (1900 MHz)			
		1 (2100 MHz)			
		7 (2600 MHz)			
LARA-R6401	North America	71 (600 MHz)			
		12 (700 MHz)			
		13 (700 MHz)			
		14 (700 MHz)			
		5 (850 MHz)			
		4 (1700 MHz)			
		66 (1700 MHz)			
2 (1900 MHz)					
LARA-R6801	Europe, Middle East, Africa	28 (700 MHz)		5 (850 MHz)	GSM 850
	Asia-Pacific	20 (800 MHz)		8 (900 MHz)	E-GSM 900
	Japan	18 (850 MHz)		2 (1900 MHz)	DCS 1800
	Latin America	19 (850 MHz)		1 (2100 MHz)	PCS 1900
		26 (850 MHz)			
		5 (850 MHz)			
		8 (900 MHz)			
		4 (1700 MHz)			
		3 (1800 MHz)			
		2 (1900 MHz)			
		1 (2100 MHz)			
		7 (2600 MHz)			

**Table 2: LARA-R6 series supported LTE, 3G and 2G bands summary**

4G LTE	3G UMTS/HSDPA/HSUPA	2G GSM/GPRS/EDGE
3GPP Release 10	3GPP Release 8	3GPP Release 9
Long Term Evolution (LTE)	High Speed Packet Access (HSPA)	Enhanced Data rate GSM Evolution (EDGE)
Evolved UTRA (E-UTRA)	UMTS Terrestrial Radio Access (UTRA)	GSM EGPRS Radio Access (GERA)
Frequency/Time Division Duplex (FDD/TDD)	Frequency Division Duplex (FDD)	Time Division Multiple Access (TDMA)
DL Rx diversity	DL Rx Diversity	DL Advanced Rx Performance Phase 1
LTE Power Class	UMTS/HSDPA/HSUPA Power Class	GSM/GPRS (GMSK) Power Class
<ul style="list-style-type: none"> <li>Power Class 3 (23 dBm)</li> </ul>	<ul style="list-style-type: none"> <li>Class 3 (24 dBm)</li> </ul>	<ul style="list-style-type: none"> <li>Class 4 (33 dBm) for 850/900 band</li> <li>Class 1 (30 dBm) for 1800/1900 band</li> </ul>
		EDGE (8-PSK) Power Class
		<ul style="list-style-type: none"> <li>Class E2 (27 dBm) for 850/900 band</li> <li>Class E2 (26 dBm) for 1800/1900 band</li> </ul>
Data rate	Data rate	Data rate
<ul style="list-style-type: none"> <li>LTE category 1: up to 10.3 Mbit/s DL, up to 5.2 Mbit/s UL</li> </ul>	<ul style="list-style-type: none"> <li>HSDPA category 8: up to 7.2 Mbit/s DL</li> <li>HSUPA category 6: up to 5.76 Mbit/s UL</li> </ul>	<ul style="list-style-type: none"> <li>GPRS multi-slot class 33<sup>2</sup>, CS1-CS4, up to 107 kbit/s DL, 85.6 kbit/s UL</li> <li>EDGE multi-slot class 33<sup>2</sup>, MCS1-MCS9, up to 296 kbit/s DL, 236.8 kbit/s UL</li> </ul>

**Table 3: LARA-R6 series LTE, 3G and 2G characteristics summary**
<sup>1</sup> LARA-R6 modules support all E-UTRA channel bandwidths for each operating band according to 3GPP TS 36.521-1 [10]

<sup>2</sup> GPRS/EDGE multislot class 33 implies a maximum of 5 slots in DL (reception), 4 slots in UL (transmission) with 6 slots in total.

## 1.5 AT command support

The LARA-R6 series modules support AT commands according to 3GPP standards TS 27.007 [7], TS 27.005 [8] and the u-blox AT command extension.

 For a complete list of supported AT commands, see the AT commands manual [1].

RIL (Radio Interface Layer) software for Android is available free of charge; see the Android RIL source code application note [3] for the supported software deliveries and more information.

## 1.6 Supported features

Table 4 lists some of the main features supported by LARA-R6 series modules. For more details, see the AT commands manual [1] and the application development guide [5].

Feature	Description
Device security	An immutable chip ID and Root of Trust (RoT) embedded in a dedicated Common Criteria EAL5+ high certified secure element provide foundational security and a unique device identity. Device security features include: <ul style="list-style-type: none"> <li>Secure boot: software authenticity and integrity</li> <li>Secure update: secure delivery of the correct FW to the module</li> <li>Anticlone detection and rejection: system automatically identifies and blocks clones that use the same RoT</li> </ul>
Data security	Secure libraries allow generation of crypto functions and keys for local encryption to secure local file storage and for end-to-end encryption. Data security features include: <ul style="list-style-type: none"> <li>Local data protection: symmetric crypto functions via AT command to locally encrypt / decrypt and authenticate data (e.g., certificates, tokens) on the device. Allows also secure local storage of sensitive information in a non-secure location (e.g., in “standard” device memory)</li> <li>E2E symmetric KMS: highly scalable method to provision and manage a session unique PSK available in cloud via REST API. Up to 8 times reduction in secure communication data overhead reducing data power consumption and cost</li> <li>E2E data protection: encrypt data on a device and decrypt asynchronously in cloud independent of protocols, servers, platforms, or time before reaching final destination</li> </ul>
u-blox Firmware update Over The Air (uFOTA)	u-blox firmware module update over the air interface client/server solution using LwM2M.
Firmware update Over AT commands (FOAT)	Firmware module update over AT command interfaces.
VoLTE and CSFB audio capability <sup>3</sup>	Voice over LTE (VoLTE) feature allows voice service over LTE bearer, via embedded IP Multimedia Subsystem (IMS). Circuit Switched Fall-Back (CSFB) feature allows voice service over circuit switched infrastructure (3G or 2G radio access technologies, which are not supported by LARA-R6401 modules).
LTE / 3G Rx Diversity	Improved cellular link quality and reliability on all operating bands, by means of 2 receiving antenna.
Network indication	GPIO configured to indicate the network status: registered home network, registered roaming, voice or data call enabled, or no service. The feature can be enabled by the +UGPIOC AT command.
Antenna detection	The <b>ANT_DET</b> pin provides antenna presence detection capability, as optional features, evaluating the resistance from <b>ANT1</b> and <b>ANT2</b> pins to GND by means of an external antenna detection circuit implemented on the application board.
Antenna dynamic tuning <sup>4</sup>	Control of an external antenna matching IC via two GPIOs changing dynamically the high/low state in real time according to the cellular band used by the module.
Jamming detection	Detects “artificial” interference that obscures the operator’s carriers entitled to give access to the radio service and reports the start and stop of such conditions to the application processor that can react accordingly.

<sup>3</sup> Not supported by LARA-R6001D and LARA-R6401D module product versions

<sup>4</sup> Not supported by LARA-R6001, LARA-R6001D and LARA-R6801 module product versions



Feature	Description
Embedded TCP and UDP stack	Embedded TCP/IP and UDP/IP stack including direct link mode for TCP and UDP sockets. Sockets can be set in Direct Link mode to establish a transparent end to end communication with an already connected TCP or UDP socket via serial interface.
Embedded FTP, FTPS	File Transfer Protocol as well as Secure File Transfer Protocol (SSL encryption of FTP control channel) functionalities are supported by means of AT commands.
Embedded HTTP, HTTPS	Hyper-Text Transfer Protocol as well as Secure Hyper-Text Transfer Protocol (SSL encryption) functionalities are supported via AT commands.
CoAP (RFC 7252)	Embedded Constrained Application Protocol (CoAP) datagram-based client/server application protocol designed to easily translate from HTTP for simplified integration with the web.
MQTT Anywhere and MQTT Flex	Integrated MQTT-SN client for MQTT Anywhere IoT Communication-as-a-Service support in combination with external Thingstream SIM, or for MQTT Flex IoT Communication-as-a-Service support in combination with any external SIM
MQTT (v3.1.1) and MQTT-SN (v1.2)	Embedded Message Queuing Telemetry Transport (MQTT) and MQTT for Sensor Networks (MQTT-SN) publish-subscribe messaging protocols designed for lightweight M2M communications over TCP (MQTT) or over UDP (MQTT-SN). These allow one-to-one, one-to-many and many-to-one communications over a TCP or UDP connection.
LwM2M	The LwM2M is a light and compact communication protocol designed for managing IoT machine-to-machine communication between a LwM2M server and a LwM2M client located in lightweight, low power, or resource-constrained LwM2M devices, with object data model.
TLS (v1.0, v1.1, v1.2, v1.3) and DTLS (v1.2)	Transport Layer Security (TLS) provides security for HTTP, FTP, MQTT, and TCP communications. Embedded Datagram Transport Layer Security (DTLS) provides security for LwM2M, and UDP communications.
DNS	Support for DNS functionality.
IPv4/IPv6 dual-stack	Capability to move between IPv4 and dual stack network infrastructures. IPv4 and IPv6 addresses can be used.
PPP	IPv4/IPv6 packets relaying through the cellular protocol stack performed on a Point-to-Point Protocol (PPP) connection established with the external application via a serial interface. Transitions between Online command mode (OLCM) and PPP mode are supported.
Multiple PDP contexts	Multiple PDP contexts can be activated, and multi secondary PDP contexts be associated to a primary PDP context.
ODIS	Open mobile alliance device management IMEI Sync (ODIS) is an AT&T functionality required at the cellular module level and used to identify the end device operating inside the network.
BIP	Bearer Independent Protocol (BIP) for Over-the-Air SIM provisioning. The data transfer to/from the SIM uses either an already active PDP context or a new PDP context established with the APN provided by the SIM card.
External u-blox GNSS control via modem	Access to u-blox positioning chips and modules is available through a dedicated I2C interface. This means that from any host processor, a single serial port can control the cellular module and the u-blox positioning chip or module. For more details, see the GNSS application note <a href="#">[6]</a> .
Embedded AssistNow software	Embedded AssistNow Online and AssistNow Offline clients are available to provide better GNSS performance and faster Time-to-First-Fix. An AT command can enable / disable the clients.
CellLocate®	Enables the estimation of device position based on the parameters of the mobile network cells visible to the specific device based on the CellLocate® database A set of AT commands allows CellLocate® service configuration and position request.   u-blox is extremely mindful of user privacy. When a position is sent to the CellLocate® server, u-blox is unable to track the SIM used or the specific device.
Hybrid positioning	The current module position is provided by a u-blox positioning chip or module or the estimated position from CellLocate® depending on which method provides the best and fastest solution according to the user configuration. A set of AT commands allows Hybrid positioning service configuration and position request.

Feature	Description
Smart Temperature Supervisor	<p>Constant monitoring of the module board temperature:</p> <ul style="list-style-type: none"> <li>Warning notification when the temperature approaches an upper or lower predefined threshold</li> <li>Shutdown notified and forced when the temperature value is outside the specified range (shutdown suspended in case of an emergency call in progress)</li> </ul> <p>The optional Smart Temperature Supervisor feature is by default disabled, and it can be enabled and configured through the +USTS AT command.</p> <p> The sensor measures the board temperature, which can differ from ambient temperature.</p>
Last gasp	In case of power supply outage the cellular module can be configured through the +ULGASP AT command to send an alarm notification to a remote entity.
Low power idle mode	The power saving configuration is disabled by default, but it can be enabled and configured using the +UPSV AT command. When the power saving is enabled, the module automatically enters the low power idle mode whenever possible, reducing current consumption.
Fast Dormancy	The Fast Dormancy feature, based on 3GPP specifications, allows reduction of current consumption and network utilization during periods of data inactivity.
3GPP Power Saving Mode (PSM) <sup>5</sup>	The Power Saving Mode (PSM) feature, based on 3GPP specifications, allows further reduction of the module current consumption maximizing the amount of time a device can remain in PSM low power deep-sleep mode during periods of data inactivity.
LTE eDRX	Extended idle mode Discontinuous Reception (eDRX) feature, based on 3GPP specifications, reduces the amount of signaling overhead decreasing the frequency of scheduled measurements and/or transmissions performed by the module in idle mode. This in turn leads to a reduction in the module power consumption while maintaining a perpetual connection with the base station.
Backup and restore	This feature allows the modules to autonomously restore the flash file system using the last backup stored on the module itself. For further details about the backup and restore feature, see the +UBKUPDATA AT command description in the AT commands manual [1], and the related section in the application development guide [5].

**Table 4: Some of the main features supported by LARA-R6 series modules**

<sup>5</sup> Supported in future firmware version

## 2 Interfaces

### 2.1 Power management

#### 2.1.1 Module supply input (VCC)

LARA-R6 series modules must be supplied through the three **VCC** pins by a DC power supply. Voltage must be stable, because during operation the current drawn from **VCC** can vary by some order of magnitude, especially due to the surging consumption profile of the GSM system (described in the system integration manual [2]). It is important that the system power supply circuit can support peak power.

LARA-R6 series modules provide separate supply inputs over the three **VCC** pins:

- **VCC** pins #52 and #53 represent the supply input for the internal RF power amplifiers, demanding most of the total current drawn by the module when RF transmission is enabled
- **VCC** pin #51 represents the supply input for the internal baseband Power Management Unit and the internal transceiver, demanding a minor part of the total current drawn by the module when RF transmission is enabled

#### 2.1.2 Generic digital interfaces supply output (V\_INT)

LARA-R6 series modules provide a 1.8 V supply rail output on the **V\_INT** pin, which is internally generated when the module is switched on. The same voltage domain is used internally to supply the generic digital interfaces of the modules (as the UARTs, I2C, I2S, GPIOs). The **V\_INT** supply output can be used in place of an external discrete regulator.

 It is recommended to provide accessible test point directly connected to the **V\_INT** input pin.

### 2.2 Antenna interfaces

#### 2.2.1 Antenna RF interfaces

The modules have two RF pins with a characteristic impedance of 50  $\Omega$ . The primary antenna pin (**ANT1**) supports both Tx and Rx, providing the main antenna interface, while the secondary antenna pin (**ANT2**) supports Rx only for the LTE / 3G Rx diversity configuration.

#### 2.2.2 Antenna detection

The **ANT\_DET** pin is an Analog to Digital Converter (ADC) input with a current source provided by LARA-R6 series modules to sense the external antenna(s) presence (as an optional feature). It evaluates the resistance from **ANT1** and **ANT2** pins to GND by means of an external antenna detection circuit implemented on the application board. For more details, see the system integration manual [2] and the AT commands manual [1].

### 2.3 System functions

#### 2.3.1 Module power-on

When LARA-R6 series modules are not powered, they can be switched on as following:

- Applying a voltage at the **VCC** module supply input within the operating range (see Table 12), and then forcing a low level at the **PWR\_ON** input pin, which is normally set high by an internal pull-up, for a valid time period (see section 4.2.9, module switch on).

When LARA-R6 series modules are in power-off mode (switched off, with a voltage at the **VCC** module supply input within the normal operating range reported in [Table 12](#)), they can be switched on by:

- Forcing a low level at the **PWR\_ON** input pin, which is normally set high by an internal pull-up, for a valid time period (see section [4.2.9](#), module switch-on). The **PWR\_ON** line is intended to be driven by open drain, open collector, or contact switch.

 It is recommended to provide accessible test point directly connected to the **PWR\_ON** input pin.

## 2.3.2 Module power-off

LARA-R6 series can be properly switched off, with storage of the current parameter settings in the module's internal non-volatile memory and a clean network detach, in one of these ways:

- AT+CPWROFF command (see the AT commands manual [\[1\]](#)).
- Forcing a low pulse at the **PWR\_ON** input pin, which is normally set high by an internal pull-up, for a valid time period (see section [4.2.9](#), module graceful switch-off). The **PWR\_ON** line is intended to be driven by open drain, open collector or contact switch.

An faster and safe emergency power-off procedure of LARA-R6 series modules with storage of the current parameter settings and without a clean network detach can be triggered by:

- AT+CFUN=10 command (see the AT commands manual [\[1\]](#)).
- Toggling the GPIO input pin configured with the fast and safe power-off function (see section [2.8](#))

An abrupt shutdown occurs on LARA-R6 series modules, without storage of the current parameter settings and without a clean network detach, when:

- The **VCC** supply drops below the extended operating range minimum limit
- Forcing a low level at the **RESET\_N** input pin, which is normally set high by an internal pull-up, for a valid time period (see [4.2.10](#), module abrupt emergency switch-off). The **RESET\_N** line is intended to be driven by open drain, open collector or contact switch.

An over-temperature or an under-temperature shutdown occurs on LARA-R6 series modules when the temperature measured within the cellular module reaches the dangerous area if the optional Smart Temperature Supervisor feature is enabled and configured by the dedicated AT command. For more details, see [4.2.15](#) and the +USTS AT command description in the AT commands manual [\[1\]](#).

## 2.3.3 Module reset

LARA-R6 series modules can be reset (rebooted), with storage of the current parameter settings in the module's internal non-volatile memory and a clean network detach, by:

- AT+CFUN=16 command (see the AT commands manual [\[1\]](#) for description and other options).
- Forcing a low level at the **RESET\_N** input pin, which is normally set high by an internal pull-up, for a valid time period (see [4.2.10](#), module reset / reboot). The **RESET\_N** line is intended to be driven by open drain, open collector or contact switch.

## 2.4 SIM interface

### 2.4.1 SIM card / chip interface

LARA-R6 series modules include an interface to connect an external SIM card / chip over the **VSIM**, **SIM\_IO**, **SIM\_CLK**, **SIM\_RST** pins: the high-speed SIM/ME interface is implemented as well as the automatic detection of the required SIM supporting voltage.

Both 1.8 V and 3.0 V SIM types are supported (1.8 V and 3.0 V ME). Activation and deactivation with automatic voltage switch from 1.8 V to 3.0 V is implemented, according to ISO-IEC 7816-3 specs.

## 2.4.2 SIM card detection

LARA-R6 series modules provide the SIM detection function over the **GPIO5** pin to sense the SIM card physical presence (as an optional feature) when the pin of the module is properly connected to the mechanical switch of the SIM card holder (see the system integration manual [2]).

## 2.5 Serial communication

LARA-R6 series modules provide the following serial communication interfaces:

- Two UART interfaces: serial interfaces available for the communication with a host application processor (AT commands, data, FW update by means of FOAT).
- USB interface: Universal Serial Bus 2.0 compliant interface available for the communication with a host application processor (AT commands, data communication, FW update by means of the FOAT feature), for FW update by means of the u-blox EasyFlash tool and for diagnostic.
- I2C interface: I2C bus compatible interface available for the communication with u-blox GNSS positioning chips/modules and with external I2C devices as an audio codec.

### 2.5.1 UART interfaces

LARA-R6 series modules include a main primary Universal Asynchronous Receiver/Transmitter serial interface (UART) for communication with an application host processor, supporting AT commands, data communication, multiplexer protocol functionality including virtual channel for GNSS tunneling, and FW update by means of FOAT:

- 8-wire serial port with RS-232 functionality conforming to ITU-T V.24 recommendation [13], with CMOS compatible levels (0 V for low data bit / ON state, 1.8 V for high data bit / OFF state)
  - Data lines (**RXD** output, **TXD** input),
  - hardware flow control lines (**CTS** output, **RTS** input),
  - modem status and control lines (**DTR** input, **DSR** output, **DCD** output, **RI** output)<sup>6</sup>
- Hardware flow control (default factory-programmed setting), or none flow control are supported
- 115'200 bit/s (default factory-programmed setting), 230'400 bit/s, 460'800 bit/s, 921'600 bit/s, and 3'000'000 bit/s baud rates are supported
- The default factory-programmed frame format is 8N1 (8 data bits, no parity, 1 stop bit)

LARA-R6 series modules include a secondary auxiliary Universal Asynchronous Receiver/Transmitter serial interface (UART AUX) for communication with an application host processor, supporting AT commands, data communication, and FW update by means of FOAT:

- 4-wire serial port with RS-232 functionality conforming to ITU-T V.24 recommendation [13], with CMOS compatible signal levels (0 V for low data bit / ON state, 1.8 V for high data bit / OFF state)
  - Data lines (**DCD** as data output, **DTR** as data input)
  - HW flow control lines (**RI** as flow control output, **DSR** as flow control input)
- Hardware flow control (default setting), or none flow control are supported
- 115'200 bit/s (default setting), 230'400 bit/s, 460'800 bit/s, 921'600 bit/s, and 3'000'000 bit/s baud rates are supported
- The default frame format is 8N1 (8 data bits, no parity, 1 stop bit)

The UART serial interfaces can be conveniently configured through dedicated AT commands: see the AT commands manual [1] (+IPR, +ICF, +IFC, &K, \Q, &S, &D, &C, +UPSV, +USIO, +UUARTCONF AT commands).

<sup>6</sup> Alternatively, **DTR**, **DSR**, **DCD** and **RI** pins can be mutually exclusively configured as a secondary auxiliary UART interface

### 2.5.1.1 Multiplexer protocol

LARA-R6 series modules include multiplexer functionality as per 3GPP TS 27.010 [9] on the main primary UART physical interface. The multiplexer functionality is not supported on the secondary auxiliary UART physical interface.

The multiplexer functionality is a data link protocol which uses HDLC-like framing and operates between the module (DCE) and the application processor (DTE), allowing several simultaneous sessions over the physical link (main primary UART): the user can concurrently use AT interface on one MUX channel and data communication on another MUX channel.

The following virtual channels are available:

- Multiplexer control
- AT commands / data connection
- GNSS data tunneling

### 2.5.2 USB interface

LARA-R6 series modules include a USB High-Speed 2.0 compliant interface with a maximum 480 Mbit/s data rate according to the Universal Serial Bus specification revision 2.0 [14]. The module itself acts as a USB device and can be connected to any compatible USB host.

The USB interface is available for communication with a host application processor (AT commands, data communication, GNSS tunneling, FW update by means of the FOAT feature), for FW update by means of the u-blox EasyFlash tool and for diagnostics.

The **USB\_D+** / **USB\_D-** lines carry the USB data and signaling. The USB interface is automatically enabled by an external valid USB VBUS voltage applied on the **VUSB\_DET** input pin of the module.

 The USB interface of the LARA-R6 series modules is enabled only if an external voltage detectable as High logic level (see Table 25 for the electrical characteristics) is present at the **VUSB\_DET** input during the switch-on boot sequence of the module. This configuration can be changed by the +UUSBDET AT command on all LARA-R6 series modules versions except LARA-R6001D-00B.

The USB interface makes several functions available with various capabilities and purposes, such as:

- Virtual serial port over USB for AT commands and data communication
- Virtual serial port over USB for GNSS tunneling
- Virtual serial port over USB for Diagnostic log

The user can concurrently use AT command interface on one virtual serial port, and packet switched / circuit switched data communication on another virtual serial port over USB.

LARA-R6 series modules are compatible with the standard Linux/Android USB kernel drivers.

 It is highly recommended to provide access to the **VUSB\_DET**, **USB\_D+**, **USB\_D-** pins for FW update and for diagnostic purpose, by means of test points directly connected to the pins.

### 2.5.3 I2C interface

LARA-R6 series modules include an I2C-bus compatible interface (**SDA** and **SCL** pins) available to communicate with an external u-blox GNSS chips / modules, and with external compatible I2C devices as for example an audio codec: LARA-R6 series module acts as an I2C host which can communicate with I2C local devices in accordance with the I2C bus specifications [15].

For more details regarding I2C interface usage and the integration with a u-blox GNSS receiver, see the LARA-R6 series system integration manual [2], GNSS implementation application note [6], and the I2C and GNSS AT commands description in the u-blox AT commands manual [1].

## 2.6 Audio interface

 LARA-R6001D the LARA-R6401D data-only product versions do not support of voice / audio.

LARA-R6 series modules support Voice over LTE (VoLTE) as well as Circuit-Switched Fall-Back (CSFB) from LTE to 3G or 2G radio bearer for providing audio services.

LARA-R6 series modules include a 4-wire I2S digital audio interface (**I2S\_TXD**, **I2S\_RXD**, **I2S\_CLK**, **I2S\_WA**) that can be configured by AT command to transfer digital audio data to/from an external device as an audio codec.

For more details regarding I2S digital audio interface possible configurations, usage and guideline for the integration with an external digital audio device as an audio codec, see the LARA-R6 series system integration manual [2] and the audio sections in the AT commands manual [1].

## 2.7 Clock output

 LARA-R6001D the LARA-R6401D data-only product versions do not support **GPIO6** clock output.

LARA-R6 series modules provide digital clock output functionality on the **GPIO6** pin. This is mainly designed to feed the clock input of an external audio codec, as the clock output is generated only when the audio is active. For more details, see the AT commands manual [1], +UMCLK AT command.

## 2.8 GPIO pins

LARA-R6 series modules include 9 pins (**GPIO1-GPIO5**, **I2S\_TXD**, **I2S\_RXD**, **I2S\_CLK**, **I2S\_WA**) that can be configured as General Purpose Input/Output or to provide custom functions as summarized in the [Table 5](#) (for further details, see the GPIO section in the AT commands manual [1]).

Function	Description	Default GPIO	Configurable GPIOs
Network status indication	Network status: registered home network, registered roaming, data transmission, no service	--	GPIO1, GPIO2, GPIO3, GPIO4
GNSS supply enable	Enable/disable the supply of u-blox GNSS receiver connected to the cellular module	GPIO2	GPIO1, GPIO2, GPIO3, GPIO4
GNSS data ready	Sense when u-blox GNSS receiver connected to the module is ready for sending data by the I2C	GPIO3	GPIO3
SIM card detection	External SIM card physical presence detection	GPIO5	GPIO5
SIM card hot insertion/removal	Enable / disable SIM interface upon detection of external SIM card physical insertion / removal	--	GPIO5
RI	Main UART Ring Indicator output function	--	All
DTR	Main UART DTR input line function	--	GPIO3, GPIO4
Last gasp	Input to trigger last gasp notification by applying a rising or falling edge according to AT+ULGASP setting	--	GPIO3
Faster and safe power-off	Input to trigger emergency fast and safe shutdown of the module (as AT+CFUN=10) by applying a rising edge	--	GPIO3
I2S digital audio interface <sup>7</sup>	I2S digital audio interface	I2S_RXD, I2S_TXD, I2S_CLK, I2S_WA	I2S_RXD, I2S_TXD, I2S_CLK, I2S_WA
General purpose input	Input to sense high or low digital level	--	All
General purpose output	Output to set the high or the low digital level	GPIO4	All
Pin disabled	Tri-state with an internal active pull-down enabled	GPIO1	All

**Table 5: GPIO custom functions configuration**

<sup>7</sup> I2S is not supported by LARA-R6001D and LARA-R6401D data-only versions: I2S pins are by default set as Pin disabled.



## 2.9 Antenna dynamic tuner interface

 The antenna dynamic tuner interface is not supported by LARA-R6001-00B, LARA-R6001D-00B and LARA-R6801-00B modules product versions.

The LARA-R6401 and LARA-R6401D modules includes two 1.8 V digital output pins (**RFCTRL1** and **RFCTRL2**) that are configured to control in real time an external antenna tuning IC, as optional available feature, changing their output value dynamically according to the specific actual cellular band in use by the module as indicated in [Table 6](#).

RFCTRL1	RFCTRL2	LTE frequency band in use
0	0	B2, B4, B5, B66
0	1	N/A
1	0	B12, B13, B14
1	1	B71

Table 6: LARA-R6401 / LARA-R6401D modules antenna dynamic tuning truth table

## 2.10 Reserved pins

LARA-R6 series modules include pins reserved for future use, marked as **RSVD**, which can all be left unconnected on the application board, except connecting a test point to the **RSVD #33** pin.



## 3 Pin definition

### 3.1 Pin assignment

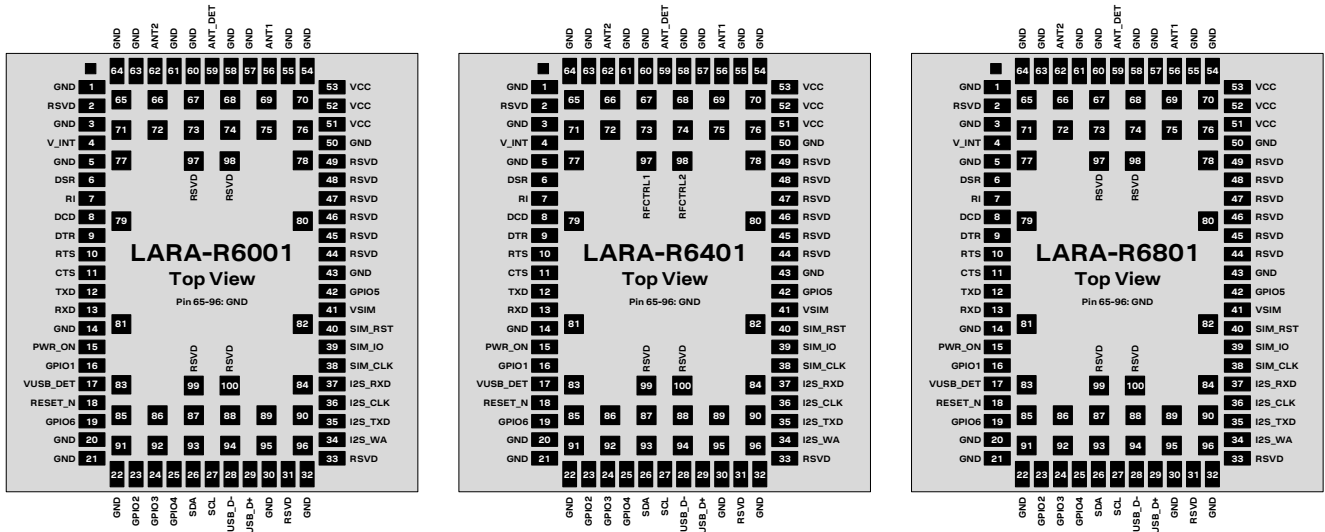

Figure 2: LARA-R6 series pin assignment (top view)

No	Name	Power domain	I/O	Description	Remarks
1	GND	-	N/A	Ground	All the GND pins are intended to be connected to ground
2	RSVD	-	N/A	RESERVED pin	Pin reserved for future use. Internally not connected.
3	GND	-	N/A	Ground	All the GND pins are intended to be connected to ground
4	V_INT	-	O	Generic Digital Interfaces supply output	V_INT = 1.8 V (typical) generated by the module when it is switched-on, outside low power deep sleep mode. See section 4.2.3 for detailed electrical specs. Provide test point for diagnostic purposes.
5	GND	-	N/A	Ground	All the GND pins are intended to be connected to ground
6	DSR	GDI	O / I	UART data set ready / AUX UART request to send	Circuit 107 in ITU-T V.24 (DSR output, push-pull, idle high, active low), alternatively configurable as second auxiliary UART RTS (HW flow control input, idle high, active low, with internal active pull-up enabled). See section 4.2.14 for detailed electrical specs.
7	RI	GDI	O / O	UART ring indicator / AUX UART clear to send	Circuit 125 in ITU-T V.24 (RI output, push-pull, idle high, active low), alternatively configurable as second auxiliary UART CTS (HW flow control output, push-pull, idle high, active low). See section 4.2.14 for detailed electrical specs.
8	DCD	GDI	O / O	UART data carrier detect / AUX UART data output	Circuit 109 in ITU-T V.24 (DCD output, push-pull, idle high, active low), alternatively settable as Second Auxiliary UART RXD (data output, push-pull, idle high, active low). See section 4.2.14 for detailed electrical specs.
9	DTR	GDI	I / I	UART data terminal ready / AUX UART data input	Circuit 108/2 in ITU-T V. 24 (DTR input, idle high, active low, with internal active pull-up enabled), alternatively settable as Second Auxiliary UART TXD (data input, idle high, active low, with internal active pull-up enabled). See section 4.2.14 for detailed electrical specs.
10	RTS	GDI	I	UART ready to send	Circuit 105 in ITU-T V.24 (RTS flow control input, idle high, active low, with internal active pull-up enabled). See section 4.2.14 for detailed electrical specs.

No	Name	Power domain	I/O	Description	Remarks
11	CTS	GDI	O	UART clear to send	Circuit 106 in ITU-T V.24 (CTS hardware flow control output, push-pull, idle high, active low). See section 4.2.14 for detailed electrical specs.
12	TXD	GDI	I	UART data input	Circuit 103 in ITU-T V.24 (TxD data input, idle high, active low, with internal active pull-up enabled). See section 4.2.14 for detailed electrical specs.
13	RXD	GDI	O	UART data output	Circuit 104 in ITU-T V.24 (RxD data output, push-pull, idle high, active low). See section 4.2.14 for detailed electrical specs.
14	GND	-	N/A	Ground	All the GND pins are intended to be connected to ground
15	PWR_ON	POS	I	Power-on input	Internal pull-up. Active low. See section 4.2.9 for detailed electrical specs. Provide test point for diagnostic purposes.
16	GPIO1	GDI	I/O	GPIO	GPIO configurable as described in section 2.8. Push-pull output type. See section 4.2.14 for detailed electrical specs.
17	VUSB_DET	VBUS	I	VBUS USB detect input	VBUS (5 V typical) USB supply generated by the host must be connected to this input pin during the switch-on boot sequence of the module to enable the USB interface. See section 4.2.12 for detailed electrical specs. Provide test point for diagnostic purposes.
18	RESET_N	ERS	I	External reset input	Internal 10 kΩ pull-up resistor to V_BCKP. See section 4.2.10 for detailed electrical specs.
19	GPIO6	GDI	O	Clock output	Configurable clock output as described in section 2.7. Not supported by LARA-R6001D and LARA-R6401D. Push-pull output type. See section 4.2.14 / 4.2.14.1 for detailed electrical specs.
20	GND	-	N/A	Ground	All the GND pins are intended to be connected to ground
21	GND	-	N/A	Ground	All the GND pins are intended to be connected to ground
22	GND	-	N/A	Ground	All the GND pins are intended to be connected to ground
23	GPIO2	GDI	I/O	GPIO	GPIO configurable as described in section 2.8. Push-pull output type. See section 4.2.14 for detailed electrical specs.
24	GPIO3	GDI	I/O	GPIO	GPIO configurable as described in section 2.8. Push-pull output type. See section 4.2.14 for detailed electrical specs.
25	GPIO4	GDI	I/O	GPIO	GPIO configurable as described in section 2.8. Push-pull output type. See section 4.2.14 for detailed electrical specs.
26	SDA	I2C	I/O	I2C bus data line	Open drain output type. Active low. Internal 2.2 kΩ pull-up resistor to V_INT. See section 4.2.13 for detailed electrical specs.
27	SCL	I2C	O	I2C bus clock line	Open drain output type. Active low. Internal 2.2 kΩ pull-up resistor to V_INT. See section 4.2.13 for detailed electrical specs.
28	USB_D-	USB	I/O	USB Data Line D-	90 Ω nominal differential characteristic impedance. Pull-up, pull-down and series resistors as required by the USB 2.0 specifications [14] are part of the USB pin driver and need not be provided externally. See section 4.2.12 for detailed electrical specs. Provide test point for diagnostic purposes.

No	Name	Power domain	I/O	Description	Remarks
29	USB_D+	USB	I/O	USB Data Line D+	90 Ω nominal differential characteristic impedance. Pull-up, pull-down and series resistors as required by the USB 2.0 specifications [14] are part of the USB pin driver and need not be provided externally. See section 4.2.12 for detailed electrical specs. Provide test point for diagnostic purposes.
30	GND	-	N/A	Ground	All the GND pins are intended to be connected to ground
31	RSVD	-	N/A	RESERVED pin	Pin reserved for future use. Internally not connected.
32	GND	-	N/A	Ground	All the GND pins are intended to be connected to ground
33	RSVD	-	N/A	RESERVED pin	Pin reserved with special function. Provide test point for diagnostic purposes.
34	I2S_WA	GDI	O / I/O	I2S word alignment / GPIO	Settable as I2S word alignment, or as GPIO (see 2.6, 2.8). Push-pull output type. I2S not supported by LARA-R6001D and LARA-R6401D. See section 4.2.14 for detailed electrical specs.
35	I2S_TXD	GDI	O / I/O	I2S transmit data / GPIO	Configurable as I2S data output, or as GPIO (see 2.6, 2.8). Push-pull output type. I2S not supported by LARA-R6001D and LARA-R6401D. See section 4.2.14 for detailed electrical specs.
36	I2S_CLK	GDI	O / I/O	I2S clock / GPIO	Configurable as I2S clock, or as GPIO (see 2.6, 2.8). Push-pull output type. I2S not supported by LARA-R6001D and LARA-R6401D. See section 4.2.14 for detailed electrical specs.
37	I2S_RXD	GDI	I / I/O	I2S receive data / GPIO	Configurable as I2S data input, or as GPIO (see 2.6, 2.8). Push-pull output type. I2S not supported by LARA-R6001D and LARA-R6401D. See section 4.2.14 for detailed electrical specs.
38	SIM_CLK	SIM	O	SIM clock	See section 4.2.10 for detailed electrical specs.
39	SIM_IO	SIM	I/O	SIM data	Internal 4.7 kΩ pull-up resistor to VSIM. See section 4.2.10 for detailed electrical specs.
40	SIM_RST	SIM	O	SIM reset	See section 4.2.10 for detailed electrical specs.
41	VSIM	-	O	SIM supply output	VSIM = 1.80 V typical or 2.95 V typical generated by the module according to the external SIM card/chip type. See section 4.2.3 for detailed electrical specs.
42	GPIO5	GDI	I/O	GPIO	Configurable for SIM card detection, or as GPIO (see 2.8). Push-pull output type. See section 4.2.14 for detailed electrical specs.
43	GND	-	N/A	Ground	All the GND pins are intended to be connected to ground
44	RSVD	-	N/A	RESERVED pin	Pin reserved for future use.
45	RSVD	-	N/A	RESERVED pin	Pin reserved for future use.
46	RSVD	-	N/A	RESERVED pin	Pin reserved for future use.
47	RSVD	-	N/A	RESERVED pin	Pin reserved for future use.
48	RSVD	-	N/A	RESERVED pin	Pin reserved for future use.
49	RSVD	-	N/A	RESERVED pin	Pin reserved for future use.
50	GND	-	N/A	Ground	All the GND pins are intended to be connected to ground
51	VCC	-	I	Module supply input	Supply input for baseband Power Management Unit part. All VCC pins must be connected to external supply. See sections 4.2.3 and 4.2.4 for detailed specs.
52	VCC	-	I	Module supply input	Supply for RF Power Amplifiers part. All VCC pins must be connected to external supply. See sections 4.2.3 and 4.2.4 for detailed specs.



No	Name	Power domain	I/O	Description	Remarks
53	VCC	-	I	Module supply input	Supply for RF Power Amplifiers part. All VCC pins must be connected to external supply. See sections 4.2.3 and 4.2.4 for detailed specs.
54	GND	-	N/A	Ground	All the GND pins are intended to be connected to ground
55	GND	-	N/A	Ground	All the GND pins are intended to be connected to ground
56	ANT1	ANT	I/O	Primary antenna	50 $\Omega$ nominal characteristic impedance. Main Tx / Rx antenna interface. See section 4.2.5, 4.2.6, 0 for details.
57	GND	GND	N/A	Ground	All the GND pins are intended to be connected to ground
58	GND	GND	N/A	Ground	All the GND pins are intended to be connected to ground
59	ANT_DET	ADC	I	Antenna detection	ADC input for antenna presence detection function. See section 4.2.8 for detailed electrical specs.
60	GND	GND	N/A	Ground	All the GND pins are intended to be connected to ground
61	GND	GND	N/A	Ground	All the GND pins are intended to be connected to ground
62	ANT2	ANT	I	Secondary antenna	50 $\Omega$ nominal characteristic impedance. Rx only for Down-Link Rx diversity. See section 4.2.5, 4.2.6 for details.
63	GND	-	N/A	Ground	All the GND pins are intended to be connected to ground
64	GND	-	N/A	Ground	All the GND pins are intended to be connected to ground
65-96	GND	-	N/A	Ground	All the GND pins are intended to be connected to ground
97	RFCTRL1	GDI	O	RF control output	LARA-R6401 and LARA-R6401D only. 1.8 V push-pull output to dynamically control external RF antenna tuning IC, changing the high/low state in real time according to the cellular RF band in use by the module. See section 4.2.14 for detailed electrical specs.
	RSVD		N/A	RESERVED pin	LARA-R6001, LARA-R6001D and LARA-R6801 only. Pin reserved for future use.
98	RFCTRL2	GDI	O	RF control output	LARA-R6401 and LARA-R6401D only. 1.8 V push-pull output to dynamically control external RF antenna tuning IC, changing the high/low state in real time according to the cellular RF band in use by the module. See section 4.2.14 for detailed electrical specs.
	RSVD	-	N/A	RESERVED pin	LARA-R6001, LARA-R6001D and LARA-R6801 only. Pin reserved for future use.
99	RSVD	-	N/A	RESERVED pin	Pin reserved for future use.
100	RSVD	-	N/A	RESERVED pin	Pin reserved for future use.

**Table 7: LARA-R6 series pin-out**

 For more information about the pin-out, see the system integration manual [2].

 See appendix A for an explanation of the abbreviations and terms used.

## 4 Electrical specifications

-  Stressing the device above one or more of the ratings listed in the Absolute Maximum Rating section may cause permanent damage. These are stress ratings only. Operating the module at these or at any conditions other than those specified in the Operating Conditions sections (section 4.2) of the specification should be avoided. Exposure to Absolute Maximum Rating conditions for extended periods may affect device reliability.
-  Electrical characteristics are defined according to the verification on a representative number of samples or according to the simulation.
-  Where application information is given, it is advisory only and does not form part of the specification.

### 4.1 Absolute maximum rating

-  Limit values given below are in accordance with the Absolute Maximum Rating System (IEC 134).

Symbol	Description	Condition	Min.	Max.	Unit
VCC	Module supply voltage	Input DC voltage at VCC pin	-0.5	6.0	V
VUSB_DET	USB detection pin	Input DC voltage at VUSB_DET pin	-0.3	5.5	V
USB	USB D+/D- pins	Input DC voltage at USB_D+ and USB_D- pins	-0.3	3.6	V
GDI	Generic digital interfaces	Input DC voltage at Generic digital interfaces pins	-0.3	2.1	V
I2C	I2C interface	Input DC voltage at I2C interface pins	-0.3	2.1	V
SIM	SIM interface	Input DC voltage at SIM interface pins	-0.3	3.6	V
ERS	External reset signal	Input DC voltage at RESET_N pin	-0.3	2.1	V
POS	Power-on input	Input DC voltage at PWR_ON pin	-0.3	2.1	V
Rho_ANT	Antenna ruggedness	Output RF load mismatch ruggedness at ANT pins		10:1	VSWR
Tstg	Storage Temperature		-40	+85	°C

**Table 8: Absolute maximum ratings**

-  The product is not protected against overvoltage or reversed voltages. If necessary, voltage spikes exceeding the power supply voltage specification, given in the table above, must be limited to values within the specified boundaries by using appropriate protection devices.

#### 4.1.1 Maximum ESD

Parameter	Min.	Max.	Unit	Remarks
ESD sensitivity for all pins		1000	V	Human Body Model according to JS-001-2017
		500	V	Charged Device Model according to JS-002-2018

**Table 9: Maximum ESD ratings**

-  u-blox cellular modules are Electrostatic Sensitive Devices and require special precautions when handling. See section 7.4 for ESD handling instructions.

## 4.2 Operating conditions

Unless otherwise indicated, all operating condition specifications are at an ambient temperature of +25 °C.

Operation beyond the operating conditions is not recommended and extended exposure beyond them may affect device reliability.

### 4.2.1 Operating temperature range

Parameter	Min.	Typical	Max.	Unit	Remarks
Normal operating temperature	-20	+25	+65	°C	Operating within 3GPP / ETSI specifications
Extended operating temperature	-40		+85	°C	Operating with possible slight deviation in RF performance outside normal operating range

Table 10: Environmental conditions

### 4.2.2 Thermal parameters

Symbol	Parameter	Min.	Typ.	Max.	Unit	Remarks
$\Psi_{M-A}$	Module-to-Ambient thermal parameter	10			°C/W	Thermal characterization parameter $\Psi_{M-A} = (T_M - T_A) / P_H$ proportional to the delta between internal module temperature ( $T_M$ ) and ambient temperature ( $T_A$ ), due to heat power dissipation ( $P_H$ ), with the module mounted on a 79 x 62 x 1.41 mm 4-Layer PCB with a high coverage of copper, in still air conditions
$\Psi_{M-C}$	Module-to-Case thermal parameter	3			°C/W	Thermal characterization parameter $\Psi_{M-C} = (T_M - T_C) / P_H$ proportional to the delta between internal module temperature ( $T_M$ ) and ambient temperature ( $T_C$ ), due to heat power dissipation ( $P_H$ ), with the module mounted on a 79 x 62 x 1.41 mm 4-Layer PCB with a high coverage of copper, with a robust aluminum heat-sink and with forced air ventilation, i.e. reducing to a value close to 0 °C/W the thermal resistance from the case of the module to the ambient

Table 11: Thermal characterization parameters of the module

### 4.2.3 Supply/power pins

Symbol	Parameter	Min.	Typical	Max.	Unit
VCC	Normal operating input voltage for VCC pins 51, 52, 53 <sup>8</sup>	3.3	3.8	4.5	V
	Extended operating input voltage for VCC pin 51 <sup>9</sup>	3.1	3.8	4.5	V
	Extended operating input voltage for VCC pins 52, 53 <sup>10</sup>	2.8	3.8	4.5	V

Table 12: Input characteristics of the module Supply/Power pins

Symbol	Parameter	Min.	Typical	Max.	Unit
VSIM	SIM supply output voltage, with external 1.8 V SIM		1.80		V
	SIM supply output voltage, with external 3.0 V SIM		2.95		V
V_INT	Generic Digital Interfaces supply output voltage		1.80		V
	Generic Digital Interfaces supply output current capability			70	mA

Table 13: Output characteristics of the Supply/Power pins

<sup>8</sup> Operating within 3GPP / ETSI specifications.

<sup>9</sup> The voltage has to be above the extended operating range minimum limit for the **VCC** pin 51 (supply input for the baseband Power Management Unit and the Transceiver) to switch-on the module and to avoid possible switch-off of the module.

<sup>10</sup> Operating with possible slight deviation in RF performance outside normal operating range. The Power Amplifier may not be fully functional when the voltage drops below the extended operating range minimum limit defined for the **VCC** pins 52 and 53 (supply input for the internal Power Amplifier).

#### 4.2.4 Current consumption

Mode	Condition	Tx power	Min	Typ <sup>11</sup>	Max <sup>12</sup>	Unit
Power-off mode	Averaged current value Module switched off			9		μA
Cyclic Idle/Active-Mode (Low power mode enabled by +UPSV, Module registered with network)	Averaged current value, Idle mode floor current, USB not connected			0.9		mA
	Averaged current value, Idle mode floor current, USB suspended			1.2		mA
	Averaged current value, Cyclic eDRX = 655.36 s, USB not connected			1.1		mA
	Averaged current value, Cyclic eDRX = 655.36 s, USB suspended			1.4		mA
	Averaged current value, Cyclic eDRX = 20.48 s, USB not connected			1.6		mA
	Averaged current value, Cyclic eDRX = 20.48 s, USB suspended			1.9		mA
	Averaged current value, Cyclic DRX = 2.56 s, USB not connected			1.9		mA
	Averaged current value, Cyclic DRX = 2.56 s, USB suspended			2.2		mA
Active-Mode (Low power mode disabled by +UPSV, Module registered with network)	Averaged current value, Cyclic DRX = 2.56 s, USB not connected			10.6		mA
	Averaged current value, Cyclic DRX = 2.56 s, USB in use			27.0		mA
2G Connected Mode (Tx / Rx call enabled)	Peak value at 1-slot GMSK Tx burst, 900 MHz band	Maximum		1.5	1.9	A
		Minimum		50		mA
	Averaged value along 1-slot GMSK call, 900 MHz band	Maximum		200		mA
		Minimum		50		mA
3G Connected Mode (Tx / Rx call enabled)	Averaged value along 3G call	Minimum		200		mA
		0 dBm		220		mA
		12 dBm		300		mA
		18 dBm		440		mA
		Maximum		620		mA
LTE Connected Mode (Tx / Rx call enabled)	Averaged value along LTE-FDD call	Minimum		250		mA
		0 dBm		270		mA
		12 dBm		320		mA
		18 dBm		450		mA
		Maximum		650		mA

**Table 14: LARA-R6 series modules VCC current consumption**

<sup>11</sup> Typical values with a matched antenna

<sup>12</sup> Maximum values with a mismatched antenna

## 4.2.5 LTE RF characteristics

The LTE bands supported by each LARA-R6 module are defined in [Table 3](#), while [Table 15](#) describes the transmitting and receiving frequencies for each LTE band according to 3GPP TS 36.521-1 [10].

Parameter		Min.	Max.	Unit	Remarks
Frequency range FDD band 71 (600 MHz)	Uplink	663	698	MHz	Module transmits
	Downlink	617	652	MHz	Module receives
Frequency range FDD Band 12 (700 MHz)	Uplink	699	716	MHz	Module transmits
	Downlink	729	746	MHz	Module receives
Frequency range FDD Band 13 (700 MHz)	Uplink	777	787	MHz	Module transmits
	Downlink	746	756	MHz	Module receives
Frequency range FDD Band 14 (700 MHz)	Uplink	788	798	MHz	Module transmits
	Downlink	758	768	MHz	Module receives
Frequency range FDD Band 28 (700 MHz)	Uplink	703	748	MHz	Module transmits
	Downlink	758	803	MHz	Module receives
Frequency range FDD Band 20 (800 MHz)	Uplink	832	862	MHz	Module transmits
	Downlink	791	821	MHz	Module receives
Frequency range FDD band 26 (850 MHz)	Uplink	814	849	MHz	Module transmits
	Downlink	859	894	MHz	Module receives
Frequency range FDD band 18 (850 MHz)	Uplink	815	830	MHz	Module transmits
	Downlink	860	875	MHz	Module receives
Frequency range FDD Band 19 (850 MHz)	Uplink	830	845	MHz	Module transmits
	Downlink	875	890	MHz	Module receives
Frequency range FDD Band 5 (850 MHz)	Uplink	824	849	MHz	Module transmits
	Downlink	869	894	MHz	Module receives
Frequency range FDD Band 8 (900 MHz)	Uplink	880	915	MHz	Module transmits
	Downlink	925	960	MHz	Module receives
Frequency range FDD Band 4 (1700 MHz)	Uplink	1710	1755	MHz	Module transmits
	Downlink	2110	2155	MHz	Module receives
Frequency range FDD band 66 (1700 MHz)	Uplink	1710	1780	MHz	Module transmits
	Downlink	2110	2200	MHz	Module receives
Frequency range FDD Band 3 (1800 MHz)	Uplink	1710	1785	MHz	Module transmits
	Downlink	1805	1880	MHz	Module receives
Frequency range FDD Band 2 (1900 MHz)	Uplink	1850	1910	MHz	Module transmits
	Downlink	1930	1990	MHz	Module receives
Frequency range TDD Band 39 (1900 MHz)	Uplink	1880	1920	MHz	Module transmits
	Downlink	1880	1920	MHz	Module receives
Frequency range FDD Band 1 (2100 MHz)	Uplink	1920	1980	MHz	Module transmits
	Downlink	2110	2170	MHz	Module receives
Frequency range TDD Band 40 (2300 MHz)	Uplink	2300	2400	MHz	Module transmits
	Downlink	2300	2400	MHz	Module receives
Frequency range TDD Band 38 (2600 MHz)	Uplink	2570	2620	MHz	Module transmits
	Downlink	2570	2620	MHz	Module receives
Frequency range TDD Band 41 (2600 MHz)	Uplink	2496	2690	MHz	Module transmits
	Downlink	2496	2690	MHz	Module receives
Frequency range FDD Band 7 (2600 MHz)	Uplink	2500	2570	MHz	Module transmits
	Downlink	2620	2690	MHz	Module receives

**Table 15: LTE operating RF frequency bands**



LARA-R6 series modules include a UE Power Class 3 LTE transmitter (see [Table 3](#)), with output power and characteristics according to 3GPP TS 36.521-1 [10].

LARA-R6 series modules LTE receiver characteristics are compliant to 3GPP TS 36.521-1 [10], with LTE conducted receiver sensitivity performance described in [Table 16](#).

Parameter	Min.	Typical	Max.	Unit	Remarks
Receiver input sensitivity Band 71 (600 MHz)		-105		dBm	Channel bandwidth = 5 MHz
		-100		dBm	Channel bandwidth = 20 MHz
Receiver input sensitivity Band 12 (700 MHz)		-110		dBm	Channel bandwidth = 1.4 MHz
		-104		dBm	Channel bandwidth = 5 MHz
		-101		dBm	Channel bandwidth = 10 MHz
Receiver input sensitivity Band 13 (700 MHz)		-105		dBm	Channel bandwidth = 5 MHz
		-102		dBm	Channel bandwidth = 10 MHz
Receiver input sensitivity Band 14 (700 MHz)		-105		dBm	Channel bandwidth = 5 MHz
		-102		dBm	Channel bandwidth = 10 MHz
Receiver input sensitivity Band 28 (700 MHz)		-107		dBm	Channel bandwidth = 3 MHz
		-105		dBm	Channel bandwidth = 5 MHz
		-99.0		dBm	Channel bandwidth = 20 MHz
Receiver input sensitivity Band 20 (800 MHz)		-105		dBm	Channel bandwidth = 5 MHz
		-99.0		dBm	Channel bandwidth = 20 MHz
Receiver input sensitivity Band 26 (850 MHz)		-110		dBm	Channel bandwidth = 1.4 MHz
		-105		dBm	Channel bandwidth = 5 MHz
		-100		dBm	Channel bandwidth = 15 MHz
Receiver input sensitivity Band 18 (850 MHz)		-105		dBm	Channel bandwidth = 5 MHz
		-101		dBm	Channel bandwidth = 15 MHz
Receiver input sensitivity Band 19 (850 MHz)		-105		dBm	Channel bandwidth = 5 MHz
		-100		dBm	Channel bandwidth = 15 MHz
Receiver input sensitivity Band 5 (850 MHz)		-110		dBm	Channel bandwidth = 1.4 MHz
		-105		dBm	Channel bandwidth = 5 MHz
		-102		dBm	Channel bandwidth = 10 MHz
Receiver input sensitivity Band 8 (900 MHz)		-110		dBm	Channel bandwidth = 1.4 MHz
		-105		dBm	Channel bandwidth = 5 MHz
		-102		dBm	Channel bandwidth = 10 MHz
Receiver input sensitivity Band 4 (1700 MHz)		-110		dBm	Channel bandwidth = 1.4 MHz
		-104		dBm	Channel bandwidth = 5 MHz
		-99.0		dBm	Channel bandwidth = 20 MHz
Receiver input sensitivity Band 66 (1700 MHz)		-109		dBm	Channel bandwidth = 1.4 MHz
		-104		dBm	Channel bandwidth = 5 MHz
		-99.0		dBm	Channel bandwidth = 20 MHz
Receiver input sensitivity Band 3 (1800 MHz)		-107		dBm	Channel bandwidth = 1.4 MHz
		-102		dBm	Channel bandwidth = 5 MHz
		-96.5		dBm	Channel bandwidth = 20 MHz
Receiver input sensitivity Band 2 (1900 MHz)		-110		dBm	Channel bandwidth = 1.4 MHz
		-104		dBm	Channel bandwidth = 5 MHz
		-99.0		dBm	Channel bandwidth = 20 MHz

Parameter	Min.	Typical	Max.	Unit	Remarks
Receiver input sensitivity Band 1 (2100 MHz)		-104		dBm	Channel bandwidth = 5 MHz
		-99.0		dBm	Channel bandwidth = 20 MHz
Receiver input sensitivity Band 7 (2600 MHz)		-102		dBm	Channel bandwidth = 5 MHz
		-97.5		dBm	Channel bandwidth = 20 MHz
Receiver input sensitivity Band 39 (1900 MHz)		-105		dBm	Channel bandwidth = 5 MHz
		-100		dBm	Channel bandwidth = 20 MHz
Receiver input sensitivity Band 40 (2300 MHz)		-104		dBm	Channel bandwidth = 5 MHz
		-98.5		dBm	Channel bandwidth = 20 MHz
Receiver input sensitivity Band 38 (2600 MHz)		-103		dBm	Channel bandwidth = 5 MHz
		-98.0		dBm	Channel bandwidth = 20 MHz
Receiver input sensitivity Band 41 (2600 MHz)		-103		dBm	Channel bandwidth = 5 MHz
		-97.5		dBm	Channel bandwidth = 20 MHz

Condition: 50  $\Omega$ , throughput > 95%, dual receiver, QPSK modulation, other settings as per clause 7.3 of 3GPP TS 36.521-1 [10]

**Table 16: LTE receiver sensitivity performance**

## 4.2.6 3G RF characteristics

The 3G bands supported by LARA-R6 series modules are defined in Table 3, while Table 17 describes the transmitting and receiving frequencies for each 3G band according to 3GPP TS 34.121-1 [11].

Parameter		Min.	Max.	Unit	Remarks
Frequency range Band 5 (850 MHz)	Uplink	824	849	MHz	Module transmits
	Downlink	869	894	MHz	Module receives
Frequency range Band 8 (900 MHz)	Uplink	880	915	MHz	Module transmits
	Downlink	925	960	MHz	Module receives
Frequency range Band 2 (1900 MHz)	Uplink	1850	1910	MHz	Module transmits
	Downlink	1930	1990	MHz	Module receives
Frequency range Band 1 (2100 MHz)	Uplink	1920	1980	MHz	Module transmits
	Downlink	2110	2170	MHz	Module receives

**Table 17: 3G operating RF frequency bands**

LARA-R6 series modules include a UE Power Class 3 3G transmitter (see Table 3), with output power and characteristics according to 3GPP TS 34.121-1 [11].

LARA-R6 series modules 3G receiver characteristics are compliant to 3GPP TS 34.121-1 [11], with 3G conducted receiver sensitivity performance described in Table 18.

Parameter	Min.	Typical	Max.	Unit	Remarks
Receiver input sensitivity Band 5 (850 MHz)		-115		dBm	Downlink RF level for RMC @ BER < 0.1%
Receiver input sensitivity Band 8 (900 MHz)		-115		dBm	Downlink RF level for RMC @ BER < 0.1%
Receiver input sensitivity Band 2 (2100 MHz)		-114		dBm	Downlink RF level for RMC @ BER < 0.1%
Receiver input sensitivity Band 1 (2100 MHz)		-114		dBm	Downlink RF level for RMC @ BER < 0.1%

Condition: 50  $\Omega$ , dual receiver, other settings as per clause 6.2 of 3GPP TS 34.121-1 [11]

**Table 18: 3G receiver sensitivity performance**

## 4.2.7 2G RF characteristics

The 2G bands supported by LARA-R6 series modules are defined in [Table 3](#), while [Table 19](#) describes Transmitting and Receiving frequencies for each 2G band according to 3GPP TS 51.010-1 [\[12\]](#).

Parameter		Min	Max	Unit	Remarks
Frequency range GSM 850	Uplink	824	849	MHz	Module transmits
	Downlink	869	894	MHz	Module receives
Frequency range E-GSM 900	Uplink	880	915	MHz	Module transmits
	Downlink	925	960	MHz	Module receives
Frequency range DCS 1800	Uplink	1710	1785	MHz	Module transmits
	Downlink	1805	1880	MHz	Module receives
Frequency range PCS 1900	Uplink	1850	1910	MHz	Module transmits
	Downlink	1930	1990	MHz	Module receives

**Table 19: 2G operating RF frequency bands**

LARA-R6 series modules include a GMSK Power Class 4 transmitter for 850 / 900 MHz bands, GMSK Power Class 1 transmitter for 1800 / 1900 MHz bands, 8-PSK Power Class E2 transmitter for all 2G bands (see [Table 3](#)), with output power and characteristics according to 3GPP TS 51.010-1 [\[12\]](#).

LARA-R6 series modules 2G receiver characteristics are compliant to 3GPP TS 51.010-1 [\[12\]](#), with conducted receiver sensitivity performance described in [Table 20](#).

Parameter	Min.	Typical	Max.	Unit	Remarks
Receiver input sensitivity E-GSM 850		-110		dBm	Downlink RF level @ BER Class II < 2.4%
Receiver input sensitivity E-GSM 900		-110		dBm	Downlink RF level @ BER Class II < 2.4%
Receiver input sensitivity E-GSM 1800		-109		dBm	Downlink RF level @ BER Class II < 2.4%
Receiver input sensitivity DCS 1900		-109		dBm	Downlink RF level @ BER Class II < 2.4%

Condition: 50 Ω, other settings as per clause 14.2.1 of 3GPP TS 51.010-1 [\[12\]](#)

**Table 20: 2G receiver sensitivity performance**

## 4.2.8 ANT\_DET pin

Parameter	Min.	Typ.	Max.	Unit	Remarks
Output DC current pulse value		35		μA	Generated by means of the +UANTR AT command
Output DC current pulse time length		1160		μs	Generated by means of the +UANTR AT command

**Table 21: ANT\_DET pin characteristics**

## 4.2.9 PWR\_ON pin

Parameter	Min.	Typical	Max.	Unit	Remarks
Internal supply for PWR_ON Input Signal		1.8		V	The PWR_ON input is pulled up to an internal voltage rail minus a diode drop: the voltage value present at PWR_ON input pin is normally 0.8 V typical.
Low-level input	-0.30		0.35	V	
Pull-up resistance	150	200	250	kΩ	Internal active pull-up
Input leakage current	-0.20		0.20	μA	
PWR_ON low time	0.15		3.20	s	Low time to trigger module switch on from power off mode
		1.50		s	Low time to trigger module graceful switch off

**Table 22: PWR\_ON pin characteristics**

## 4.2.10 RESET\_N pin

Parameter	Min.	Typical	Max.	Unit	Remarks
Internal supply for RESET_N Input Signal		1.8		V	
Low-level input	-0.30		0.63	V	
Pull-up resistance		37		kΩ	Internal active pull-up
Input leakage current	-0.20		0.20	μA	
RESET_N low time	0.05		6	s	Low time to trigger module reset (reboot)
	10			s	Low time to trigger module abrupt emergency switch off

**Table 23: RESET\_N pin characteristics**

## 4.2.11 SIM pins

The SIM pins are a dedicated interface to the external SIM card/chip. The electrical characteristics fulfill the regulatory specification requirements. The values in [Table 24](#) are for information only.

Parameter	Min.	Typ.	Max.	Unit	Remarks
Low-level input	-0.30		0.2*VSIM	V	
High-level input	0.7*VSIM		VSIM+0.3	V	
Low-level output		0	0.4	V	Max value at I <sub>OL</sub> = +2.0 mA
High-level output	0.8*VSIM	VSIM		V	Max value at I <sub>OL</sub> = +2.0 mA
Internal pull-up resistor on SIM_IO		4.7		kΩ	Internal pull-up to VSIM supply
Input leakage current	-2		2	μA	V <sub>IN</sub> = 0 V or V <sub>IN</sub> = VSIM
Clock frequency on SIM_CLK		4.8		MHz	

**Table 24: SIM pins characteristics**

## 4.2.12 USB pins

USB data lines (**USB\_D+** / **USB\_D-**) are compliant with the USB 2.0 high-speed specification. See the Universal Serial Bus specification revision 2.0 [14] for detailed electrical characteristics. The values in [Table 25](#) related to USB 2.0 high-speed physical layer specifications are for information only.

Parameter	Min.	Typical	Max.	Unit	Remarks
VUSB_DET pin, High-level input	1.50	5.00	5.25	V	AT+UUSBDET=0 (factory-programmed setting)
	4.40	5.00	5.25	V	AT+UUSBDET=1
High-speed squelch detection threshold (input differential signal amplitude)	100		150	mV	
High speed disconnect detection threshold (input differential signal amplitude)	525		625	mV	
High-speed data signaling input common mode voltage range	-50		500	mV	
High-speed idle output level	-10		10	mV	
High-speed data signaling output high level	360		440	mV	
High-speed data signaling output low level	-10		10	mV	
Chirp J level (output differential voltage)	700		1100	mV	
Chirp K level (output differential voltage)	-900		-500	mV	

**Table 25: USB pins characteristics**

### 4.2.13 I2C pins

I2C lines (**SCL** and **SDA**) are compliant with the I2C-bus standard mode specification. See the I2C-bus specification [15] for detailed electrical characteristics. The values in Table 26 related to I2C-bus standard mode specifications are for information only.

Parameter	Min	Typical	Max	Unit	Remarks
Internal supply for GDI domain		1.80		V	Digital I/O Interfaces supply (V_INT)
Low-level input	-0.30	0.00	0.63	V	
High-level input	1.17	1.80	2.10	V	
Low-level output		0.00	0.45	V	Max value at I <sub>OL</sub> = +2.0 mA
Internal pull-up resistance		2.2		kΩ	
Input/output leakage current	-1		1	μA	V <sub>IN</sub> = 0 V or V <sub>IN</sub> = 1.8V
Clock frequency on SCL		100		kHz	

Table 26: I2C pins characteristics

### 4.2.14 Generic Digital Interfaces pins

Parameter	Min	Typical	Max	Unit	Remarks
Internal supply for GDI domain		1.80		V	Digital I/O Interfaces supply (V_INT)
Low-level input	-0.30	0.00	0.63	V	
High-level input	1.17	1.80	2.10	V	
Low-level output		0.00	0.45	V	Max value at I <sub>OL</sub> = +2.0 mA
High-level output	1.35	1.80		V	Min value at I <sub>OH</sub> = -2.0 mA
Input leakage current	-1		1	μA	V <sub>IN</sub> = 0 V or V <sub>IN</sub> = 1.8V
Internal pull-up /-down resistance	55		390	kΩ	

Table 27: GDI pins characteristics

#### 4.2.14.1 AC characteristics of clock output pin (GPIO6)

Parameter	Description	Min	Typical	Max	Unit	Remarks
1/T1	GPIO6 clock output frequency		12.288		MHz	AT+UMCLK=2

Table 28: AC characteristics of GPIO6 clock output pin

#### 4.2.14.2 AC characteristics of I2S pins

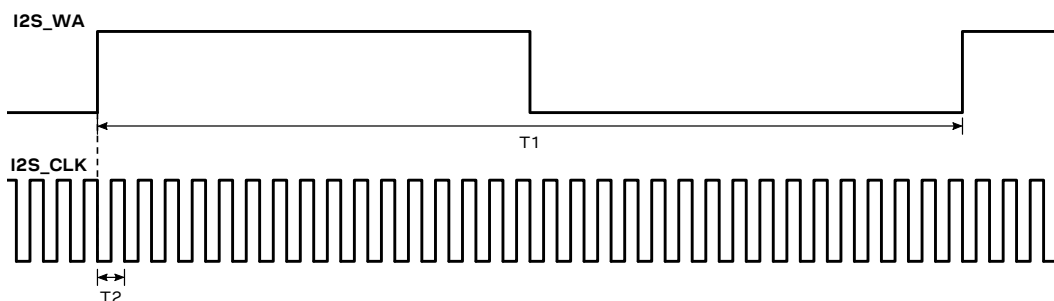
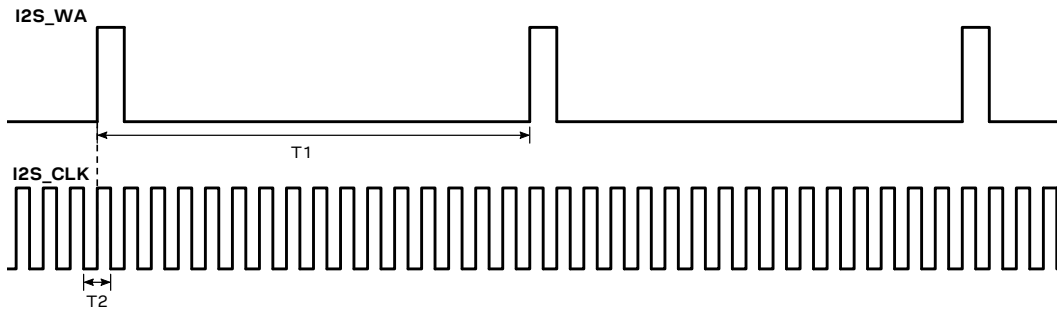

Figure 3: AC characteristics of digital audio interface (I2S) pins in Normal I2S mode (long synchronization signal), host role

Parameter	Description	Min	Typical	Max	Unit	Remarks
1/T1	I2S_WA synchronization signal frequency		16		kHz	<I2S_sample_rate> = 3
1/T2	I2S_CLK bit clock frequency		32		1/T1	<I2S_mode> = 14

Table 29: AC characteristics of digital audio interface (I2S) pins in Normal I2S mode (long synchronization signal), host role

**Figure 4: AC characteristics of digital audio interface (I2S) pins in PCM mode (short synchronization signal), host role**

Parameter	Description	Min	Typical	Max	Unit	Remarks
1/T1	I2S_WA synchronization signal frequency		16		kHz	<I2S_sample_rate> = 3
1/T2	I2S_CLK bit clock frequency		16		1/T1	<I2S_mode> = 30

**Table 30: AC characteristics of digital audio interface (I2S) pins in PCM mode (short synchronization signal), host role**

## 4.2.15 Smart temperature supervisor

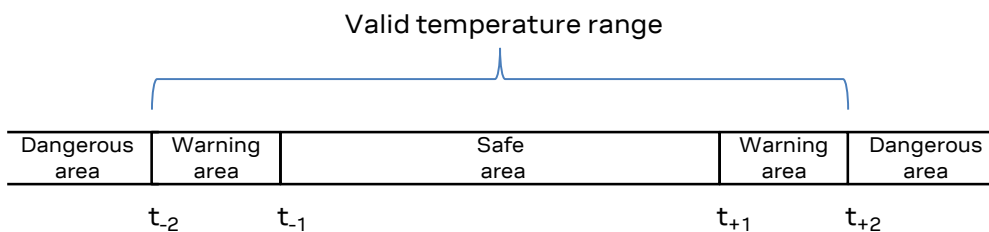
**Figure 5: Temperature range and limits**

Symbol	Parameter	Temperature
t <sub>-2</sub>	Low temperature shutdown	-40 °C
t <sub>-1</sub>	Low temperature warning	-30 °C
t <sub>+1</sub>	High temperature warning	+77 °C
t <sub>+2</sub>	High temperature shutdown	+97 °C

**Table 31: Thresholds definition for the “Smart temperature supervisor” feature on the LARA-R6 series modules**

The sensor measures the temperature inside the shield, that can differ from ambient temperature

## 4.3 Parameters for ATEX applications

This section provides useful parameters and information to integrate LARA-R6 series modules in applications intended for use in areas with potentially explosive atmospheres (ATEX), describing:

- Total internal capacitance and inductance of LARA-R6 series modules (see [Table 32](#))
- Maximum RF output power at the antenna pin of LARA-R6 series modules (see [Table 33](#))

Any specific applicable requirement for the implementation of the host apparatus integrating the modules, intended for use in potentially explosive atmospheres, must be fulfilled according to the exact applicable standards: check the detailed requisites on the pertinent normative for the application, as for example IEC 60079-0 [\[16\]](#), IEC 60079-11 [\[17\]](#), IEC 60079-26 [\[18\]](#) standards.

The certification of the application device that integrates a LARA-R6 series module and the compliance of the application device with all the applicable certification schemes, directives and standards required for use in potentially explosive atmospheres are the sole responsibility of the application device manufacturer.

Table 32 describes the maximum total internal capacitance and the maximum total internal inductance, considering internal parts tolerance, provided by LARA-R6 series modules.

Module	Parameter	Description	Value	Unit
LARA-R6001	Ci	Maximum total internal capacitance	496	μF
	Li	Maximum total internal inductance	9.8	μH
LARA-R6401	Ci	Maximum total internal capacitance	493	μF
	Li	Maximum total internal inductance	9.7	μH
LARA-R6801	Ci	Maximum total internal capacitance	496	μF
	Li	Maximum total internal inductance	9.7	μH

**Table 32: LARA-R6 series maximum total internal capacitance and maximum total internal inductance**

Table 33 describes the maximum RF output power transmitted by LARA-R6 series modules from the primary antenna (**ANT1**) pin as Power Class 4 Mobile Stations for GSM 850 / E-GSM 900 bands and/or as Power Class 3 User Equipment for the LTE / UMTS bands.

Module	Parameter	Description	Value	Unit
LARA-R6001	ANT1 Pout	Maximum RF output power from ANT1 pin	33.5	dBm
LARA-R6401	ANT1 Pout	Maximum RF output power from ANT1 pin	24.0	dBm
LARA-R6801	ANT1 Pout	Maximum RF output power from ANT1 pin	33.5	dBm

**Table 33: LARA-R6 series antenna pin (ANT1) maximum RF output power**

## 5 Mechanical specifications

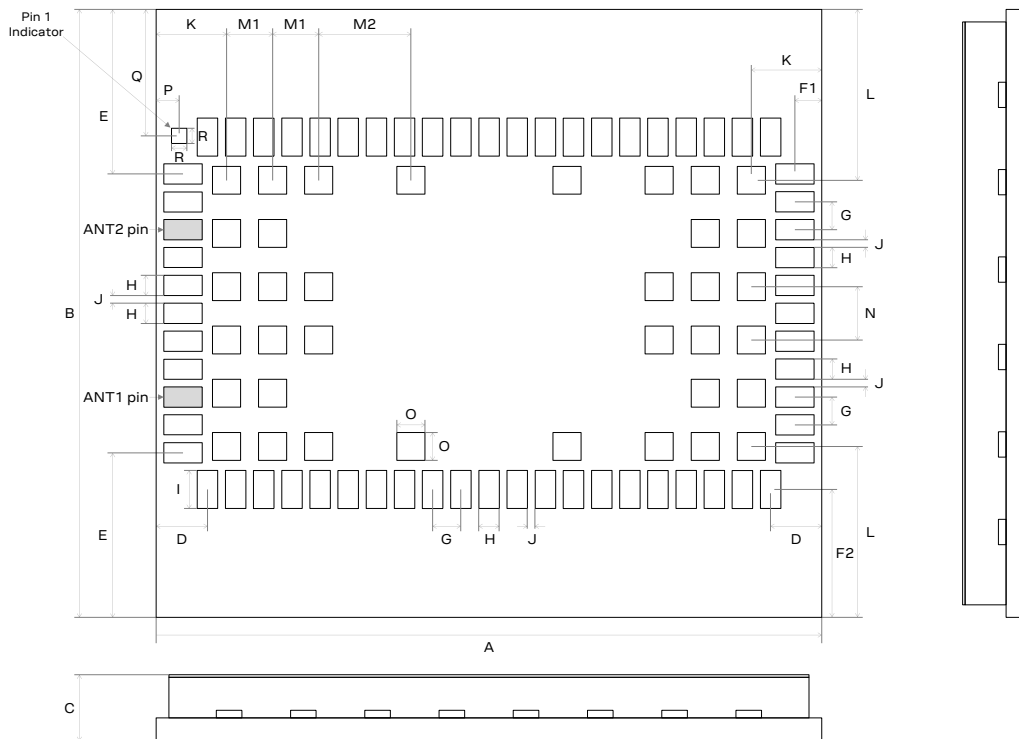

Figure 6: LARA-R6 series dimensions (bottom and side views)

Parameter	Description	Typical		Tolerance	
A	Module height [mm]	26.0	(1023.6 mil)	+0.20/-0.20	(+7.9/-7.9 mil)
B	Module width [mm]	24.0	(944.9 mil)	+0.20/-0.20	(+7.9/-7.9 mil)
C	Module thickness [mm]	2.6	(102.4 mil)	+0.27/-0.17	(+10.6/-6.7 mil)
D	Horizontal edge to lateral pin pitch [mm]	2.0	(78.7 mil)	+0.20/-0.20	(+7.9/-7.9 mil)
E	Vertical edge to lateral pin pitch [mm]	6.5	(255.9 mil)	+0.20/-0.20	(+7.9/-7.9 mil)
F1	Edge to lateral pin pitch [mm]	1.05	(41.3 mil)	+0.20/-0.20	(+7.9/-7.9 mil)
F2	Edge to lateral pin pitch [mm]	5.05	(198.8 mil)	+0.20/-0.20	(+7.9/-7.9 mil)
G	Lateral pin to pin pitch [mm]	1.1	(43.3 mil)	+0.05/-0.05	(+2.0/-2.0 mil)
H	Lateral pin height [mm]	0.8	(31.5 mil)	+0.05/-0.05	(+2.0/-2.0 mil)
I	Lateral pin width [mm]	1.5	(59.1 mil)	+0.05/-0.05	(+2.0/-2.0 mil)
J	Lateral pin to pin distance [mm]	0.3	(11.8 mil)	+0.05/-0.05	(+2.0/-2.0 mil)
K	Horizontal edge to central pin pitch [mm]	2.75	(108.3 mil)	+0.20/-0.20	(+7.9/-7.9 mil)
L	Vertical edge to central pin pitch [mm]	6.75	(265.7 mil)	+0.20/-0.20	(+7.9/-7.9 mil)
M1	Central pin to pin horizontal pitch [mm]	1.8	(70.9 mil)	+0.05/-0.05	(+2.0/-2.0 mil)
M2	Central pin to pin horizontal pitch [mm]	3.6	(141.7 mil)	+0.05/-0.05	(+2.0/-2.0 mil)
N	Central pin to pin vertical pitch [mm]	2.1	(82.7 mil)	+0.05/-0.05	(+2.0/-2.0 mil)
O	Central pin height and width [mm]	1.1	(43.3 mil)	+0.05/-0.05	(+2.0/-2.0 mil)
P	Horizontal edge to pin 1 indicator pitch [mm]	0.9	(35.4 mil)	+0.20/-0.20	(+7.9/-7.9 mil)
Q	Vertical edge to pin 1 indicator pitch [mm]	5.0	(196.8 mil)	+0.20/-0.20	(+7.9/-7.9 mil)
R	Pin 1 indicator height and width [mm]	0.6	(23.6 mil)	+0.05/-0.05	(+2.0/-2.0 mil)
Weight	Module weight [g]	4			

Table 34: LARA-R6 series dimensions

Module height tolerance  $\pm 0.20$  mm may be exceeded close to the corners of the PCB due to the cutting process. In the worst case, the height could be  $+0.40$  mm more than the typical value.

For information regarding footprint and paste mask recommended for the application board integrating the cellular module, see the system integration manual [2].



## 6 Qualification and approvals

### 6.1 Reliability tests

Reliability tests for LARA-R6 series modules are executed according to u-blox qualification policy, based on AEC-Q104 standard.

### 6.2 Approvals

LARA-R6 series modules comply with the Directive 2011/65/EU of the European Parliament and the Council on the Restriction of Use of certain Hazardous Substances in Electrical and Electronic Equipment (EU RoHS 2) and its amendment Directive (EU) 2015/863 (EU RoHS 3).

The LARA-R6 series modules are RoHS 3 compliant. No natural rubbers, hygroscopic materials, or materials containing asbestos are employed.

[Table 35](#) summarizes the main approvals for LARA-R6 series modules.

Certification scheme	LARA-R6001	LARA-R6001D	LARA-R6401	LARA-R6401D	LARA-R6801
GCF conformance	●	●	●	●	●
PTCRB conformance	●	●	●	●	
CE (Europe)	●	●			●
UKCA (Great Britain)	●	●			●
FCC (United States)	● <sup>13</sup>	● <sup>13</sup>	●	●	
FCC ID	XPYUBX21BE01	XPYUBX21BE01	XPYUBX21BE02	XPYUBX21BE02	
ISED (Canada)	●	●	●	●	
ISED certification number	8595A-UBX21BE01	8595A-UBX21BE01	8595A-UBX21BE02	8595A-UBX21BE02	
NCC (Taiwan)	●	●			●
ACMA RCM (Australia)	●	●			●
GITEKI (Japan)	●	●			●
ANATEL (Brazil)	○	○			○
KC (South Korea)	○	○			○
AT&T	○	●	●	●	
FirstNet			●	●	
Verizon	○	○	●	●	
T-Mobile US			○	○	
Vodafone	○	○			○
Deutsche Telekom	○	○			○
Telefonica	○	○			○
Telstra					○
NTT DoCoMo	○	○			○
SoftBank Mobile	○	○			○
KDDI	○	○			○

● = Available with initial product versions    ○ = Planned for future product versions

**Table 35: LARA-R6 series main certification approvals summary**

 The above listed certifications might not be available for all the different product type numbers. Please contact the u-blox office or sales representative nearest you for the complete list of certification approvals available for the selected product ordering number.

<sup>13</sup> FCC grant includes the US 900 MHz frequency spectrum within LTE band 8, enabling access to Anterix LTE private network

# 7 Product handling & soldering

## 7.1 Packaging

LARA-R6 series modules are delivered as hermetically sealed reeled tapes, to enable efficient production, production lot set-up and tear-down.

For more information about packaging, see the u-blox package information user guide [4].

### 7.1.1 Reels

LARA-R6 series modules are deliverable in quantities of 150 pieces on a reel. The modules are delivered using the reel type B2 described in the u-blox package information user guide [4].

Quantities of less than 150 pieces are also available. Contact u-blox for more information.

### 7.1.2 Tapes

Figure 7 shows the position and the orientation of LARA-R6 series modules as they are delivered on the tape, while Figure 8 and Table 36 below specify the tape dimensions.

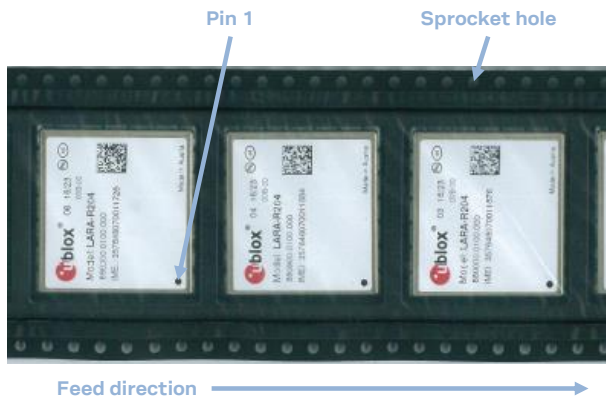

Figure 7: Orientation for LARA modules on tape

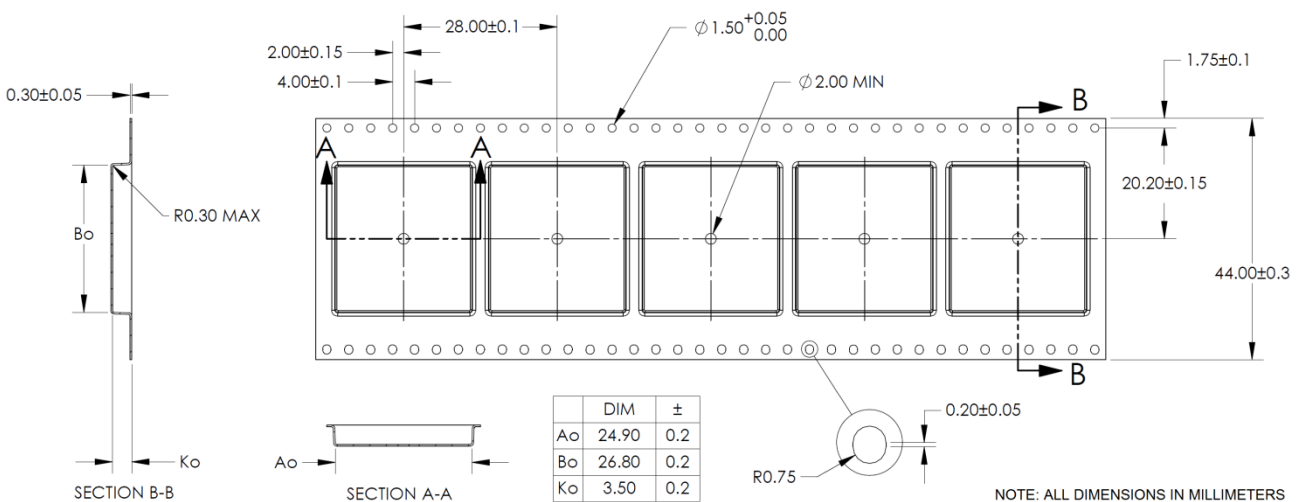





Figure 8: LARA-R6 series modules tape dimensions

Parameter	Typical value	Tolerance	Unit
A <sub>0</sub>	24.9	0.2	mm
B <sub>0</sub>	26.8	0.2	mm
K <sub>0</sub>	3.5	0.2	mm

**Table 36: LARA-R6 series modules tape dimensions**

-  10 sprocket hole pitch cumulative tolerance  $\pm 0.2$  mm.
-  Pocket position relative to sprocket hole measured as true position of pocket, not pocket hole.
-  A<sub>0</sub> and B<sub>0</sub> are measured on a plane at a distance “R” above the bottom of the pocket.

## 7.2 Moisture sensitivity levels

-  LARA-R6 series modules are Moisture Sensitive Devices (MSD) in accordance to the IPC/JEDEC specification.

The Moisture Sensitivity Level (MSL) relates to the packaging and handling precautions required. LARA-R6 series modules are rated at MSL level 4. For more information regarding moisture sensitivity levels, labeling, storage and drying see the u-blox package information user guide [4].

-  For the MSL standard, see IPC/JEDEC J-STD-020 (can be downloaded from [www.jedec.org](http://www.jedec.org)).

## 7.3 Reflow soldering

Reflow profiles are to be selected according to u-blox recommendations (see the system integration manual [2]).

-  Failure to observe these recommendations can result in severe damage to the device!

## 7.4 ESD precautions

-  LARA-R6 series modules contain highly sensitive electronic circuitry and are Electrostatic Sensitive Devices (ESD). Handling LARA-R6 series modules without proper ESD protection may destroy or damage them permanently.

LARA-R6 series modules are Electrostatic Sensitive Devices (ESD) and require special ESD precautions typically applied to ESD sensitive components.

Table 9 details the maximum ESD ratings of the LARA-R6 series modules.

Proper ESD handling and packaging procedures must be applied throughout the processing, handling and operation of any application that incorporates the LARA-R6 series module.

ESD precautions should be implemented on the application board where the module is mounted, as described in the system integration manual [2].

-  Failure to observe these recommendations can result in severe damage to the device!

## 8 Labeling and ordering information

### 8.1 Product labeling

The label of LARA-R6 series modules include important product information as described in [Figure 9](#), as the label includes: u-blox logo, production lot, Pb-free marking, product type number, IMEI number, applicable regulatory certifications' info, and production country.

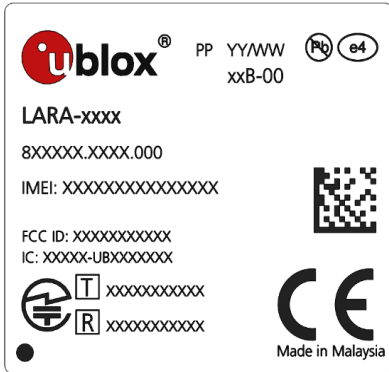

Figure 9: Illustrative example of LARA-R6 series modules' label

### 8.2 Explanation of codes

Three different product code formats are used. The Product Name is used in documentation such as this data sheet and identifies all the u-blox products, independent of packaging and quality grade. The Ordering Code includes options and quality, while the Type Number includes the hardware and firmware versions. [Table 37](#) details these 3 different formats:

Format	Structure
Product name	PPPP-TGVV(L)(HH)(F)
Ordering code	PPPP-TGVV(L)(HH)(F)-MMQ
Type number	PPPP-TGVV(L)(HH)(F)-MMQ-XX

Table 37: Product code formats

[Table 38](#) explains the parts of the product code.

Code	Meaning	Example
PPPP	Form factor	LARA
TG	Platform (technology and generation) <ul style="list-style-type: none"> <li>Dominant technology: G: GSM; U: HSUPA; C: CDMA 1xRTT; N: NB-IoT (LTE Cat NB1/NB2); R: LTE low data rate (Cat 1 and Cat M1); L: LTE high data rate (Cat 3 and above)</li> <li>Generation: 1...9</li> </ul>	R6
VV	Variant function set based on the same platform: 00...99	40
(L)	LTE category (optionally indicated): 6,4,3,1,M ...	1
(HH)	GNSS generation (indicated if supported): M8 = u-blox M8, M10 = u-blox M10, ...	M8
(F)	Special features (optionally indicated): D = data only, S = secure cloud, ...	D
MM	Major product version: 00...99	00
Q	Product grade: B = professional, A = automotive	B
XX	Minor product version: 00...99	00

Table 38: Part identification code

### 8.3 Ordering information

Ordering number	Product
LARA-R6001-00B	Global LTE FDD / TDD Cat 1 module with 3G and 2G fallback. Data and Voice product version. 26.0 x 24.0 x 2.6 mm, 150 pcs/reel
LARA-R6001D-00B	Global LTE FDD / TDD Cat 1 module with 3G and 2G fallback. Data-only product version. 26.0 x 24.0 x 2.6 mm, 150 pcs/reel
LARA-R6401-00B	LTE FDD Cat 1 module for North America. Data and Voice product version. 26.0 x 24.0 x 2.6 mm, 150 pcs/reel
LARA-R6401D-00B	LTE FDD Cat 1 module for North America. Data-only product version. 26.0 x 24.0 x 2.6 mm, 150 pcs/reel
LARA-R6801-00B	LTE FDD Cat 1 module with 3G and 2G fallback for multi-regional use. Data and Voice product version. 26.0 x 24.0 x 2.6 mm, 150 pcs/reel

**Table 39: Product ordering codes**

# Appendix

## A Glossary

Abbreviation	Definition
2G	2nd Generation Cellular Technology (GSM, GPRS, EGPRS)
3G	3rd Generation Cellular Technology (UMTS, HSDPA, HSUPA)
3GPP	3rd Generation Partnership Project
8-PSK	8 Phase-Shift Keying modulation
ACMA	Australian Communications and Media Authority
ADC	Analog to Digital Converter
ANATEL	Agência Nacional de Telecomunicações - National Telecommunications Agency (Brazil)
APAC	Asia-Pacific
AT	AT Command Interpreter Software Subsystem, or attention
Cat	Category
CE	European Conformity
CSFB	Circuit Switched Fall-Back
DL	Down-link (Reception)
DNS	Domain Name System
DTLS	Datagram Transport Layer Security
E2E	End-to-End
EAL5+	Evaluation Assurance Level 5+
eDRX	Extended Discontinuous Reception
EMEA	Europe, the Middle East and Africa
ERS	External Reset Input Signal
ESD	Electrostatic Discharge
FCC	Federal Communications Commission (United States)
FDD	Frequency Division Duplexing
FOAT	Firmware update Over AT commands
FOTA	Firmware update Over The Air
FTP	File Transfer Protocol
FW	Firmware
GCF	Global Certification Forum
GDI	Generic Digital Interfaces (power domain)
GITEKI	Gijutsu kijun tekigō shōmei - technical standard conformity certification (Japan)
GMSK	Gaussian Minimum-Shift Keying modulation
GND	Ground
GNSS	Global Navigation Satellite System
GPIO	General Purpose Input Output
HSDPA	High Speed Downlink Packet Access
HSUPA	High Speed Uplink Packet Access
HTTP	HyperText Transfer Protocol
I2C	Inter-Integrated Circuit Interface
I2S	Inter-IC Sound Interface
IEC	International Electrotechnical Commission
IMEI	International Mobile Equipment Identity

Abbreviation	Definition
IMS	IP Multimedia Subsystem
IP	Internet Protocol
ISED	Innovation, Science and Economic Development (Canada)
KC	Korea Certification
KMS	Key Management Service
LGA	Land Grid Array
LPWA	Low Power Wide Area
LTE	Long Term Evolution
LWM2M	Open Mobile Alliance Lightweight Machine-to-Machine protocol
MNO	Mobile Network Operator
MQTT	Message Queuing Telemetry Transport
MUX	Multiplexer
N/A	Not Applicable
NCC	National Communications Commission (Taiwan)
PA	Power Amplifier
PCB	Printed Circuit Board
PD	Pull-Down
PDP	Packet Data Protocol
POS	Power-On Input Signal
PMU	Power Management Unit
PSM	Power Saving Mode
PTCRB	PCS Type Certification Review Board
PU	Pull-Up
QPSK	Quadrature Phase-Shift Keying modulation
RAT	Radio Access Technology
RCM	Regulatory Compliance Mark
REST API	Representational State Transfer Application Programming Interface
RFC	Request for Comments
RMC	Reference Measurement Channel
RTC	Real Time Clock
Rx	Receiver
SIM	Subscriber Identification Module
TCP	Transmission Control Protocol
TDD	Time Division Duplexing
TEE	Trusted Execution Environment
TLS	Transport Layer Security
Tx	Transmitter
UART	Universal Asynchronous Receiver/Transmitter serial interface
UDP	User Datagram Protocol
uFOTA	u-blox Firmware update Over The Air
UL	Up-link (Transmission)
UMTS	Universal Mobile Telecommunications System
USB	Universal Serial Bus
VoLTE	Voice over LTE

**Table 40: Explanation of the abbreviations and terms used**

## Related documentation

- [1] u-blox AT commands manual, [UBX-21046719](#)
- [2] u-blox LARA-R6 series system integration manual, [UBX-21010011](#)
- [3] u-blox Android RIL source code application note, [UBX-13002041](#)
- [4] u-blox package information user guide, [UBX-14001652](#)
- [5] u-blox LARA-R6 series application development guide, [UBX-22001850](#)
- [6] u-blox GNSS implementation application note, [UBX-13001849](#)
- [7] 3GPP TS 27.007 - AT command set for User Equipment (UE)
- [8] 3GPP TS 27.005 - Use of Data Terminal Equipment - Data Circuit terminating Equipment (DTE - DCE) interface for Short Message Service (SMS) and Cell Broadcast Service (CBS)
- [9] 3GPP TS 27.010 - Terminal Equipment to User Equipment (TE-UE) multiplexer protocol
- [10] 3GPP TS 36.521-1 - Evolved Universal Terrestrial Radio Access; User Equipment conformance specification; radio transmission and reception; part 1: conformance testing
- [11] 3GPP TS 34.121-1 - User Equipment conformance specification; radio transmission and reception (FDD); part 1: conformance specification
- [12] 3GPP TS 51.010-1 - Mobile Station conformance specification; part 1: conformance specification
- [13] ITU-T recommendation V24, 02-2000. List of definitions for interchange circuits between Data Terminal Equipment (DTE) and Data Connection Equipment (DCE)
- [14] Universal Serial Bus specification, revision 2.0, <https://www.usb.org/>
- [15] I2C-bus specification and user manual - UM10204 - NXP semiconductors, <https://www.nxp.com/docs/en/user-guide/UM10204.pdf>
- [16] IEC 60079-0 - Explosive atmospheres, part 0: equipment general requirements
- [17] IEC 60079-11 - Explosive atmospheres, part 11: equipment protection by intrinsic safety 'i'
- [18] IEC 60079-26 - Explosive atmospheres, part 26: equipment with EPL Ga

 For regular updates to u-blox documentation and to receive product change notifications, register on our homepage ([www.u-blox.com](http://www.u-blox.com)).



## Revision history

Revision	Date	Name	Comments
R01	29-Apr-2021	sses	Initial release
R02	21-Dec-2021	sses / psca	Added LARA-R6001D and LARA-R6401D data-only product variants. Updated LARA-R6001 and LARA-R6401 product status. Added current consumption and sensitivity values. Revised supported features. Updated VUSB_DET characteristics. Minor other editorial changes, corrections, and clarifications.
R03	18-Jan-2022	lpah	Updated disclosure restriction to C1-Public
R04	18-Feb-2022	sses	Updated LARA-R6001D and LARA-R6401D product status. Added reboot feature for RESET_N input. Clarifications in USB description. Added smart temperature supervisor details. Added features for GPIOs. Added parameters for ATEX applications. Minor other figures and clarifications added.
R05	21-Feb-2022	sses	Corrected position of a pad in mechanical description. Corrected ESD ratings.
R06	20-Apr-2022	sses	Updated LARA-R6001D product status. Added antenna dynamic tuner description. Added thermal parameters. Added clock output characteristics. Added AC characteristics of I2S pins. Added reels and tapes description. Revised certification info. Minor data and descriptions revised or added.
R07	11-May-2022	sses	Updated LARA-R6001, LARA-R6401 and LARA-R6801 product status. Minor data and descriptions added.
R08	08-Jul-2022	sses	Updated LARA-R6401D product status. Minor editorial changes and clarifications added.
R09	18-Aug-2022	sses	Updated LARA-R6001, LARA-R6401 and LARA-R6801 product status. Minor clarifications added.

## Contact

For further support and contact information, visit us at [www.u-blox.com/support](http://www.u-blox.com/support).