



240-021

D-Subminiature Filter Connector Solder Cup / Straight PCB Contacts

How To Order Filter D-Subminiature Connectors									
Sample Part Number	240-021	S	-15	S	JF	P	G	B	-S
Series	240-021								
Contact Density	S - Standard H - High								
Number of Contacts	9, 15, 25, 26, 37, 44, 50, 62, 78, 104 (See Table II)								
Contact Type	P - Pin S - Socket (See Table I)								
Shell Material/Finish	Aluminum Shell ME - Electroless Nickel JF - Yellow Cadmium MT - Nickel-PTFE Z2 - Gold E - Chem Film			Brass Shell GS - Gold					
Filter Type	C - C Filter P - Pi Filter (See Table I)								
Filter Class	A, B, C, D, E, F, G, J (See Table I)								
Hardware Options	B - No Hardware C - 4-40 Clinch Nut								
Termination Type	P - PC Tails S - Solder Cups								

E

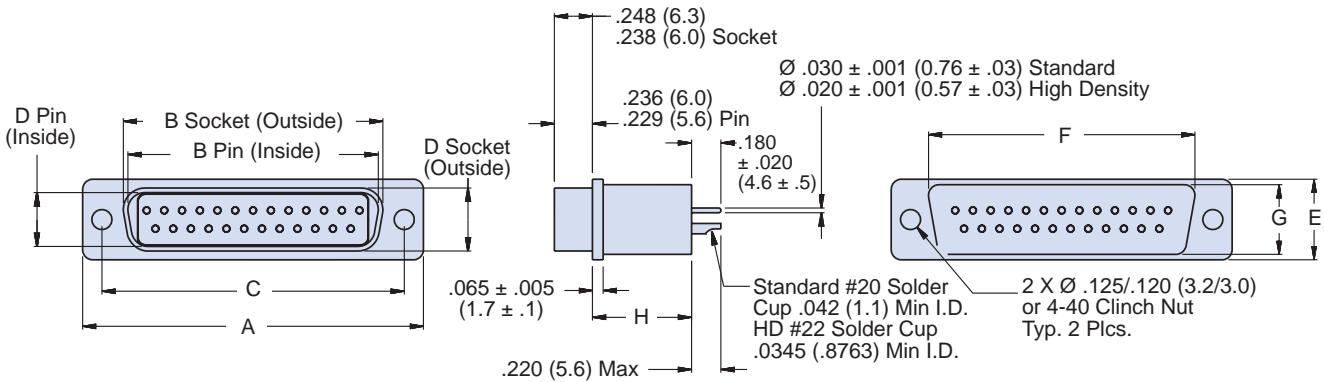

Class	Pi - Circuit (pF)	C - Circuit (pF)
A	38,000 - 56,000	19,000 - 28,000
B	32,000 - 45,000	16,000 - 22,500
C	18,000 - 33,000	9,000 - 16,500
D	8,000 - 12,000	4,000 - 6,000
E	3,300 - 5,000	1,650 - 2,500
F	800 - 1,300	400 - 650
G	400 - 600	200 - 300
J	70 - 120	35 - 60

- Notes**
1. Assembly to be identified with Glenair's name, part number, and date code space permitting
 2. Electrical Performance:
 Dielectric Withstanding Voltage: 500 VDC
 Insulation Resistance: 5,000 megohms @ 200 VDC
 Current Rating Standard Density: 7.5 Amps max.
 Current Rating High Density: 5 Amps max.
 3. Dimensions B and D taken from inside of shell for Pin/Plug and outside for Socket/ Receptacle

Materials/Finishes:
 Insulators - High Grade Rigid Dielectric/N.A.
 Contacts - Copper Alloy/Gold Plated

Dimensions in inches (millimeters) and are subject to change without notice.

240-021 D-Subminiature Filter Connector Solder Cup / Straight PCB Contacts



D-Subminiature
MIL-DTL-24308 Type

Table II: Dimensions

Shell Size	Number of Contacts		A	B	C	D	E	F Max	G Max	H
	STD	HD	±.015 (0.38)	±.005 (0.13)	±.005 (0.13)	±.005 (0.13)	±.015 (0.38)			±.010 (0.25)
1	9P	15P	1.213 (30.8)	.666 (16.9)	.984 (25.0)	.329 (8.4)	.494 (12.5)	.769 (19.5)	.432 (11.0)	Pi Filter = .610 (15.5) C Filter = .380 (9.7)
	9S	15S	1.213 (30.8)	.643 (16.3)	.984 (25.0)	.311 (7.9)	.494 (12.5)	.769 (19.5)	.432 (11.0)	
2	15P	26P	1.541 (39.1)	.994 (25.2)	1.312 (33.3)	.329 (8.4)	.494 (12.5)	1.093 (27.8)	.432 (11.0)	
	15S	26S	1.541 (39.1)	.971 (24.7)	1.312 (33.3)	.311 (7.9)	.494 (12.5)	1.093 (27.8)	.432 (11.0)	
3	25P	44P	2.088 (53.0)	1.534 (39.0)	1.852 (47.0)	.329 (8.4)	.494 (12.5)	1.635 (41.5)	.432 (11.0)	
	25S	44S	2.088 (53.0)	1.511 (38.4)	1.852 (47.0)	.311 (7.9)	.494 (12.5)	1.635 (41.5)	.432 (11.0)	
4	37P	62P	2.729 (69.3)	2.182 (55.4)	2.500 (63.5)	.329 (8.4)	.494 (12.5)	2.282 (58.0)	.432 (11.0)	
	37S	62S	2.729 (69.3)	2.159 (54.8)	2.500 (63.5)	.311 (7.9)	.494 (12.5)	2.282 (58.0)	.432 (11.0)	
5	50P	78P	2.635 (66.9)	2.079 (52.8)	2.406 (61.1)	.441 (11.2)	.605 (15.4)	2.188 (55.6)	.544 (13.8)	
	50S	78S	2.635 (66.9)	2.064 (52.4)	2.406 (61.1)	.423 (10.7)	.605 (15.4)	2.188 (55.6)	.544 (13.8)	
6	x	104P	2.729 (69.3)	2.212 (56.2)	2.500 (63.5)	.503 (12.8)	.668 (17.0)	2.312 (58.7)	.606 (15.4)	
		104S	2.729 (69.3)	2.189 (55.6)	2.500 (63.5)	.486 (12.3)	.668 (17.0)	2.312 (58.7)	.606 (15.4)	

E

Table III: Cut-Out Dimensions

Shell Size	V Min	W Bsc	X Min	Y Min	Z Min
1	.442 (11.2)	.984 (25.0)	.779 (19.8)	.396 (10.1)	.735 (18.7)
2	.442 (11.2)	1.312 (33.3)	1.110 (28.2)	.396 (10.1)	1.060 (26.9)
3	.442 (11.2)	1.852 (47.0)	1.649 (41.9)	.396 (10.1)	1.603 (40.7)
4	.442 (11.2)	2.500 (63.5)	2.296 (58.3)	.396 (10.1)	2.251 (57.2)
5	.554 (14.1)	2.406 (61.1)	2.198 (55.8)	.510 (13.0)	2.148 (54.6)
6	.616 (15.6)	2.500 (63.5)	2.322 (59.0)	.630 (16.0)	2.276 (57.8)

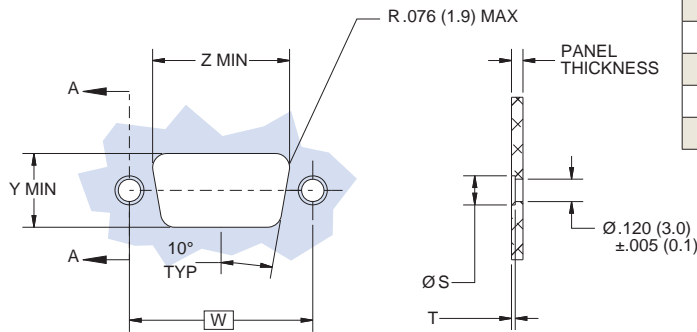

REAR PANEL MOUNT
CUTOUT RECOMMENDATIONS
AS VIEWED FROM FRONT FACE OF PANEL

SECTION A-A
TYP 2 PL

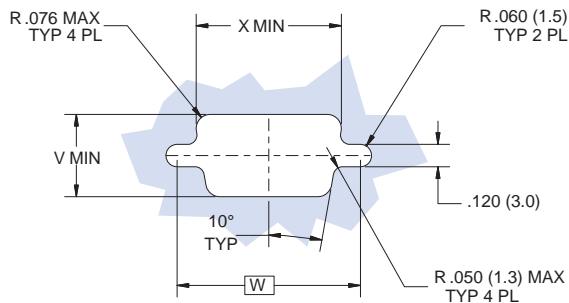

Table IV: Panel Thickness

Panel Code	Panel Thickness	S	T
R1	.031 (0.79)	N/A	N/A
R2	.047 (1.19)	.156/.199 (4.0/5.1)	.005 (0.13)
R3	.062 (1.57)	.156/.199 (4.0/5.1)	.020 (0.50)
R4	.093 (2.36)	.156/.199 (4.0/5.1)	.051 (1.30)
R5	.104 (2.64)	.156/.199 (4.0/5.1)	.061 (1.55)
R6	.125 (3.18)	.156/.199 (4.0/5.1)	.082 (2.08)
R7	.156 (3.96)	.156/.199 (4.0/5.1)	.114 (2.90)

Dimensions in inches (millimeters) and are subject to change without notice.



240-021

D-Subminiature Filter Connector

Solder Cup / Straight PCB Contacts • Connector Footprints

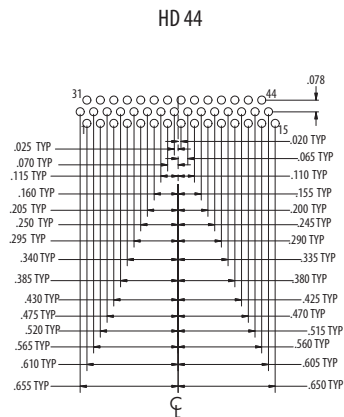
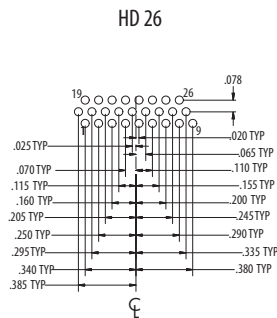
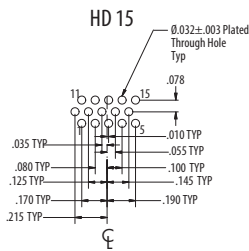
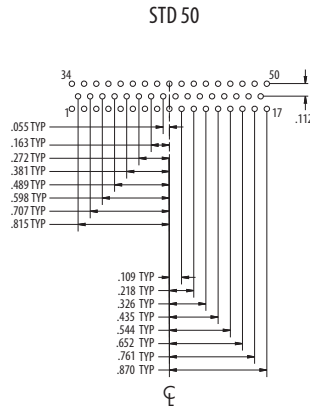
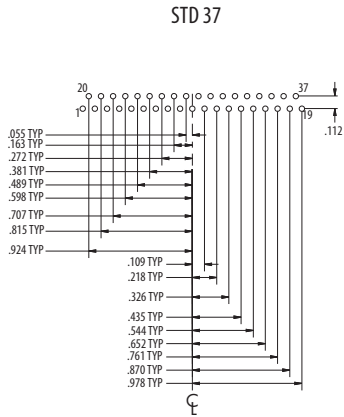
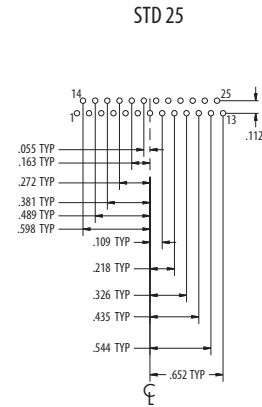
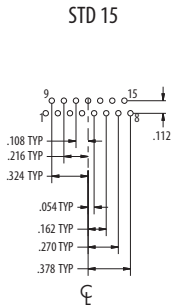
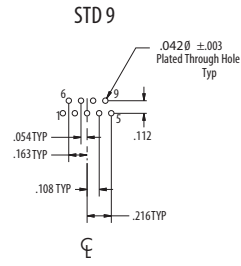

PCB patterns for high density inserts as viewed from non component side of PCB. Patterns shown are for pin inserts, sockets are mirrored around center line.

Dimensions in inches (millimeters) and are subject to change without notice.

240-021
D-Subminiature Filter Connector
 Solder Cup / Straight PCB Contacts • Connector Footprints



D-Subminiature
 MIL-DTL-24308 Type

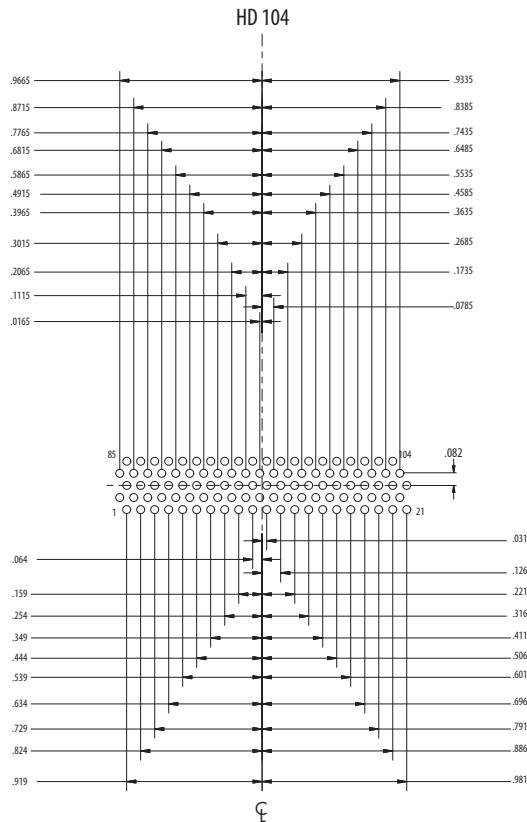
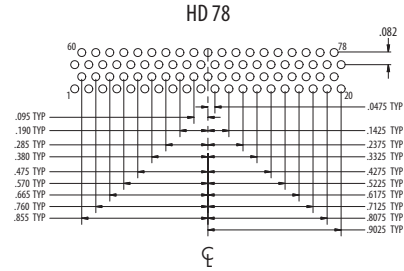
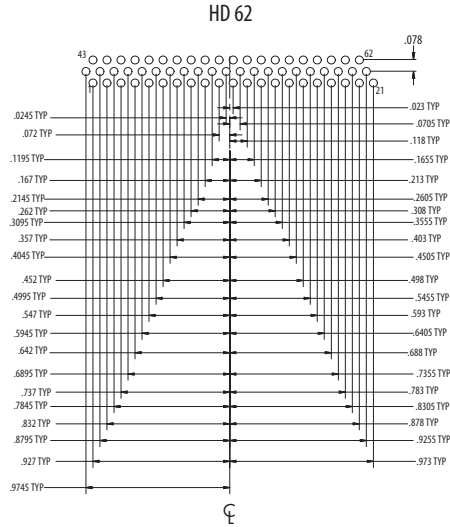

Dimensions in inches (millimeters) and are subject to change without notice.

© 2013 Glenair, Inc.

U.S. CAGE Code 06324

Printed in U.S.A.

E