



Inductors for Power Circuits

Wound Ferrite

CLF-NI-D Series

CLF7045NI-D Type

CLF7045NI-D

REMINDERS FOR USING THESE PRODUCTS

Before using these products, be sure to request the delivery specifications.

SAFETY REMINDERS

Please pay sufficient attention to the warnings for safe designing when using these products.

REMINDERS

- The storage period is less than 12 months. Be sure to follow the storage conditions (Temperature: 5 to 40°C, Humidity: 10 to 75% RH or less).
If the storage period elapses, the soldering of the terminal electrodes may deteriorate.
- Soldering corrections after mounting should be within the range of the conditions determined in the specifications.
If overheated, a short circuit, performance deterioration, or lifespan shortening may occur.
- Do not use products that have received any excessive mechanical shock such as by being dropped.
- When embedding a printed circuit board where a chip is mounted to a set, be sure that residual stress is not given to the chip due to the overall distortion of the printed circuit board and partial distortion such as at screw tightening portions.
- Self heating (temperature increase) occurs when the power is turned ON, so the tolerance should be sufficient for the set thermal design.
- Do not expose the products to magnets or magnetic fields.
- The performance of the product may deteriorate if coating materials are used, thus please assess the situation beforehand by taking this factor into consideration.
- Do not use for a purpose outside of the contents regulated in the delivery specifications.
- The products listed on this catalog are intended for use in general electronic equipment (AV equipment, telecommunications equipment, home appliances, amusement equipment, computer equipment, personal equipment, office equipment, measurement equipment, industrial robots) under a normal operation and use condition.

The products are not designed or warranted to meet the requirements of the applications listed below, whose performance and/or quality require a more stringent level of safety or reliability, or whose failure, malfunction or trouble could cause serious damage to society, person or property.

If you intend to use the products in the applications listed below or if you have special requirements exceeding the range or conditions set forth in the each catalog, please contact us.

- | | |
|---|--|
| (1) Aerospace/Aviation equipment | (8) Public information-processing equipment |
| (2) Transportation equipment (electric trains, ships, etc.) | (9) Military equipment |
| (3) Medical equipment | (10) Electric heating apparatus, burning equipment |
| (4) Power-generation control equipment | (11) Disaster prevention/crime prevention equipment |
| (5) Atomic energy-related equipment | (12) Safety equipment |
| (6) Seabed equipment | (13) Other applications that are not considered general-purpose applications |
| (7) Transportation control equipment | |

When designing your equipment even for general-purpose applications, you are kindly requested to take into consideration securing protection circuit/device or providing backup circuits in your equipment.

Inductors for Power Circuits

Wound Ferrite

Product compatible with RoHS directive
Halogen-free
Compatible with lead-free solder
AEC-Q200

Overview of CLF7045NI-D Type

FEATURES

- Magnetic shield type wound inductor for power circuits.
- It can be used at a wide temperature range. $-55\sim+150^{\circ}\text{C}$ (Including self-temperature rise)
- 1 to $470\mu\text{H}$, wide E-6 Series lineup allows for various usages.

APPLICATION

Equipment used for automobiles (ECM, airbags, headlights, electronic power steering, meters, ABS, other)

PART NUMBER CONSTRUCTION

CLF7045NI	T	-	1R0	N	-	D
Series name	Packaging style		Inductance (μH)	Inductance tolerance		Internal code
	T Taping		1R0 1.0 100 10 101 100	M $\pm 20\%$ N $\pm 30\%$		

OPERATING TEMPERATURE RANGE, PACKAGE QUANTITY, PRODUCT WEIGHT

Type	Temperature range		Package quantity (pieces/reel)	Individual weight (g)
	Operating temperature* ($^{\circ}\text{C}$)	Storage temperature** ($^{\circ}\text{C}$)		
CLF7045NI-D	-55 to $+150$	-55 to $+150$	1000	0.8

* Operating temperature range includes self-temperature rise.

** The Storage temperature range is for after the circuit board is mounted.

- RoHS Directive Compliant Product: See the following for more details related to RoHS Directive compliant products. <http://product.tdk.com/en/environment/rohs/>
- Halogen-free: Indicates that Cl content is less than 900ppm, Br content is less than 900ppm, and that the total Cl and Br content is less than 1500ppm.

 Please be sure to request delivery specifications that provide further details on the features and specifications of the products for proper and safe use.
Please note that the contents may change without any prior notice due to reasons such as upgrading.

CLF7045NI-D Type

RECOMMENDED REFLOW PROFILE



Preheating			Soldering		Peak	
Temp.	Temp.	Time	Temp.	Time	Temp.	Time
T1	T2	t1	T3	t2	T4	t3
150°C	180°C	60 to 120s	230°C	10 to 30s	245°C	5s

CLF7045NI-D Type

SHAPE & DIMENSIONS

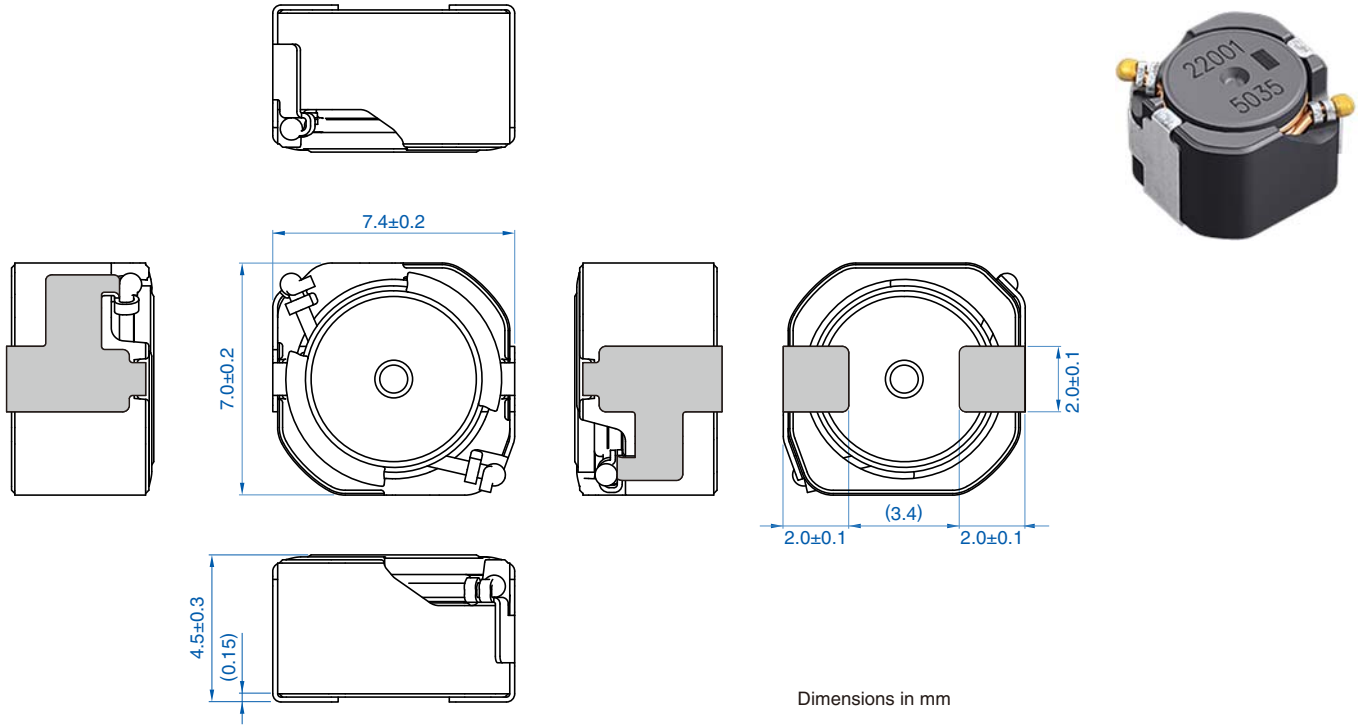

recommended land pattern

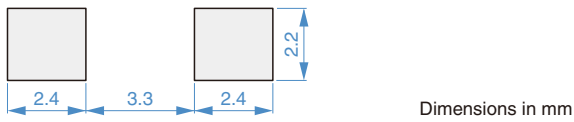

 Please be sure to request delivery specifications that provide further details on the features and specifications of the products for proper and safe use. Please note that the contents may change without any prior notice due to reasons such as upgrading.

CLF7045NI-D Type

ELECTRICAL CHARACTERISTICS

CHARACTERISTICS SPECIFICATION TABLE

L (μ H)	Tolerance	Measuring frequency	DC resistance	Rated current*		Part No.
		(kHz)	(Ω)	Isat (A)	Itemp (A)	
1.0	$\pm 30\%$	100	0.009 $\pm 30\%$	8.5	6.5	CLF7045NIT-1R0N-D
1.5	$\pm 30\%$	100	0.010 $\pm 30\%$	6.3	5.4	CLF7045NIT-1R5N-D
2.2	$\pm 30\%$	100	0.013 $\pm 30\%$	6.2	5.1	CLF7045NIT-2R2N-D
3.3	$\pm 30\%$	100	0.016 $\pm 30\%$	4.7	4.8	CLF7045NIT-3R3N-D
4.7	$\pm 30\%$	100	0.018 $\pm 30\%$	4.1	4.1	CLF7045NIT-4R7N-D
6.8	$\pm 30\%$	100	0.022 $\pm 30\%$	3.1	3.9	CLF7045NIT-6R8N-D
10	$\pm 20\%$	100	0.033 $\pm 20\%$	3.0	3.1	CLF7045NIT-100M-D
15	$\pm 20\%$	100	0.055 $\pm 20\%$	2.3	2.6	CLF7045NIT-150M-D
22	$\pm 20\%$	100	0.069 $\pm 20\%$	1.7	2.2	CLF7045NIT-220M-D
33	$\pm 20\%$	100	0.097 $\pm 20\%$	1.6	1.8	CLF7045NIT-330M-D
47	$\pm 20\%$	100	0.130 $\pm 20\%$	1.26	1.7	CLF7045NIT-470M-D
68	$\pm 20\%$	100	0.170 $\pm 20\%$	1.08	1.5	CLF7045NIT-680M-D
100	$\pm 20\%$	100	0.260 $\pm 20\%$	0.81	1.05	CLF7045NIT-101M-D
150	$\pm 20\%$	100	0.430 $\pm 20\%$	0.69	0.95	CLF7045NIT-151M-D
220	$\pm 20\%$	100	0.550 $\pm 20\%$	0.56	0.75	CLF7045NIT-221M-D
330	$\pm 20\%$	100	0.800 $\pm 20\%$	0.50	0.58	CLF7045NIT-331M-D
470	$\pm 20\%$	100	1.200 $\pm 20\%$	0.41	0.46	CLF7045NIT-471M-D

* Rated current: smaller value of either Isat or Itemp.

Isat: When based on the inductance change rate (30% below the nominal value)

Itemp: When based on the temperature increase (Temperature increase of 40°C by self heating)

Measurement equipment

Measurement item	Product No.	Manufacturer
L	4285A	Keysight Technologies
DC resistance	AN-114N	ADEX
Rated current Isat	4285A+42841A+42842C	Keysight Technologies

* Equivalent measurement equipment may be used.

CLF7045NI-D Type

ELECTRICAL CHARACTERISTICS

FREQUENCY CHARACTERISTICS GRAPH

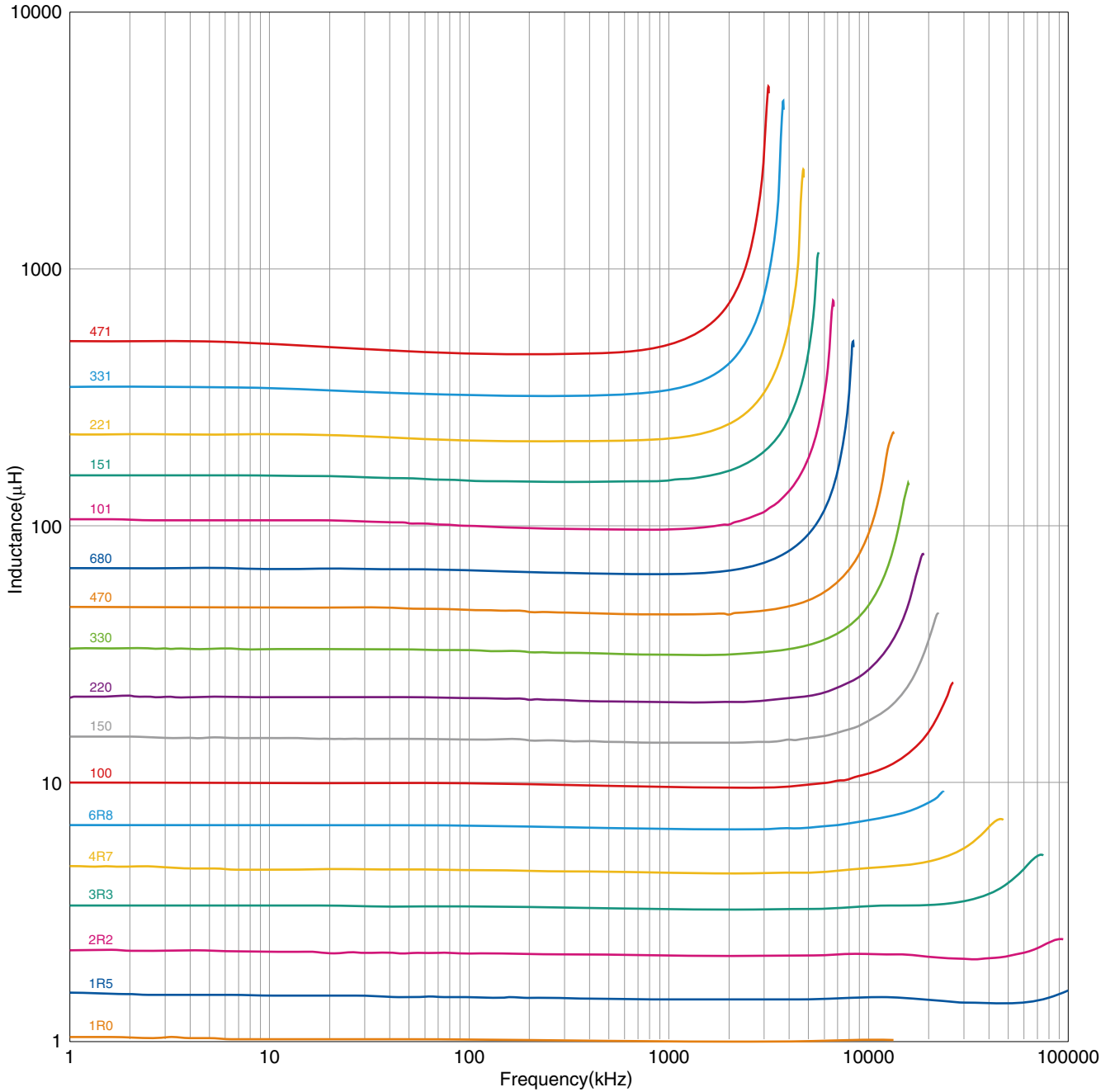

○ Measurement equipment

Product No.	Manufacturer
4285A+42841A+42842C	Keysight Technologies

* Equivalent measurement equipment may be used.

 Please be sure to request delivery specifications that provide further details on the features and specifications of the products for proper and safe use.
Please note that the contents may change without any prior notice due to reasons such as upgrading.

CLF7045NI-D Type

ELECTRICAL CHARACTERISTICS

INDUCTANCE VS. DC BIAS CHARACTERISTICS GRAPH

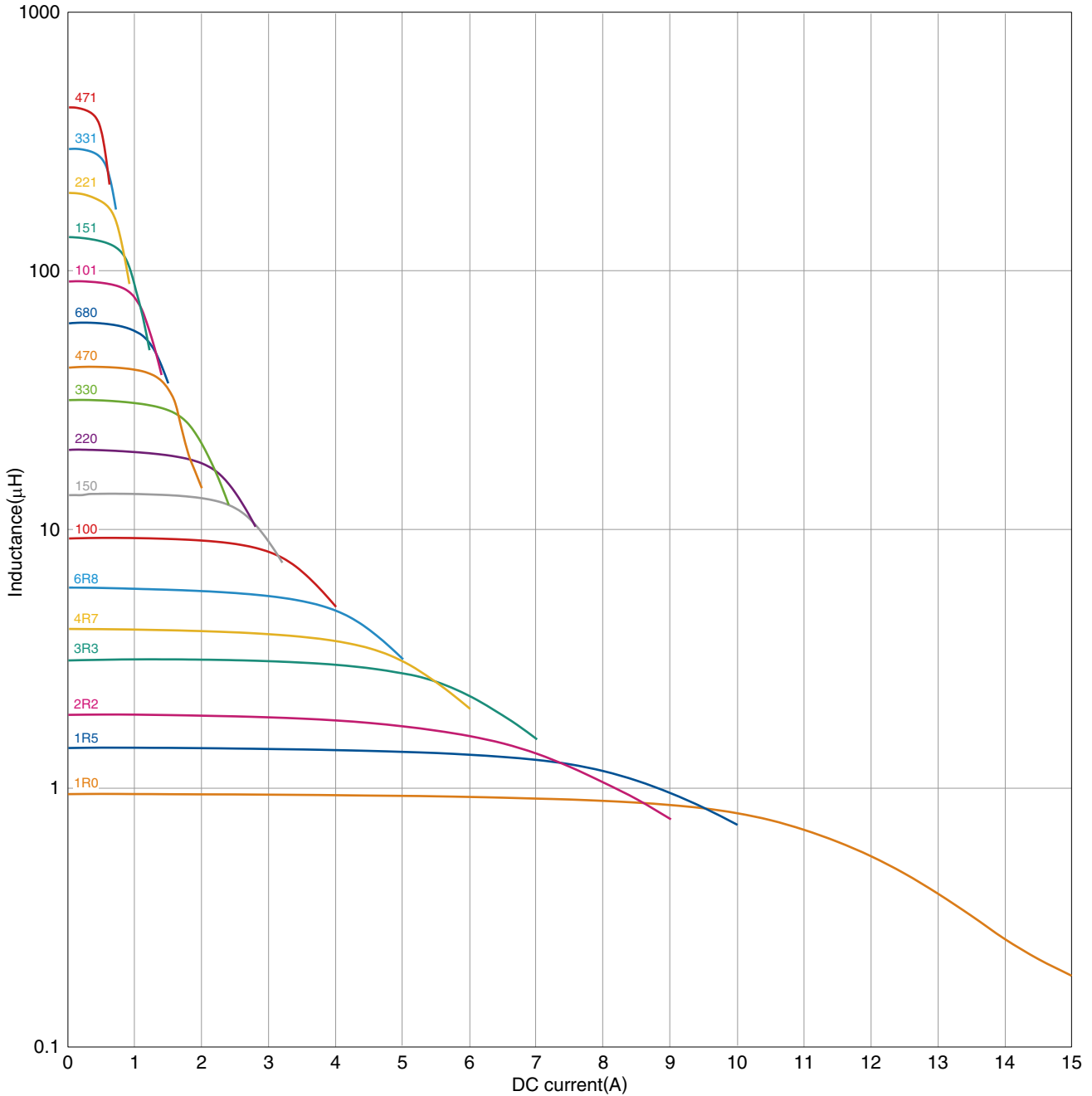

○ Measurement equipment

Product No.	Manufacturer
4285A+42841A+42842C	Keysight Technologies

* Equivalent measurement equipment may be used.

⚠ Please be sure to request delivery specifications that provide further details on the features and specifications of the products for proper and safe use. Please note that the contents may change without any prior notice due to reasons such as upgrading.

CLF7045NI-D Type

PACKAGING STYLE

REEL DIMENSIONS

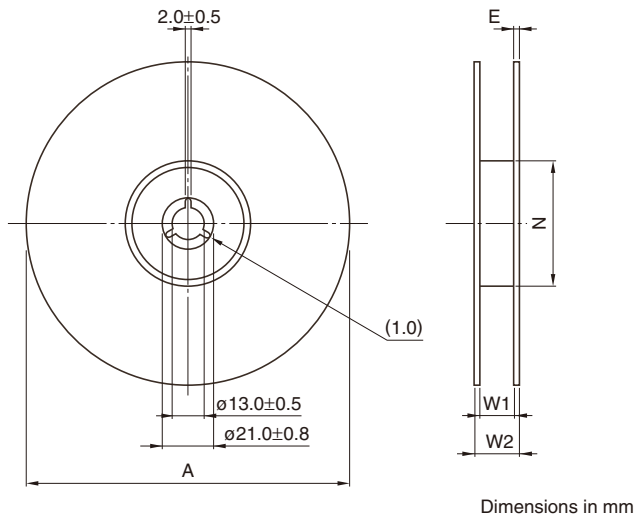

Type	A	W1	W2	N	E
CLF7045NI-D	φ330	16.4	22.4	φ100	2

* These values are typical values.

TAPE DIMENSIONS

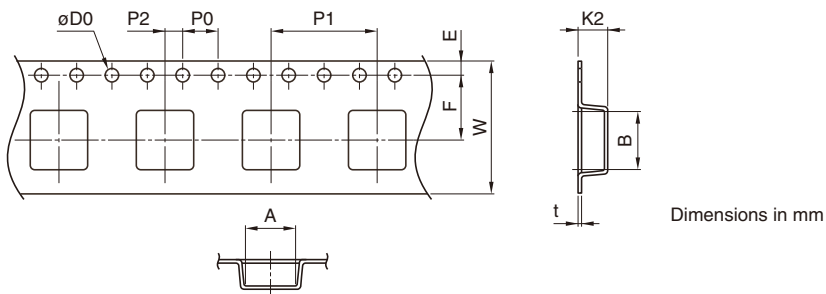

Type	A	B	φD0	E	F	P0	P1	P2	W	K2	t
CLF7045NI-D	7.8	7.4	1.5+0.1/-0	1.75±0.1	7.5±0.1	4.0±0.1	12.0±0.1	2.0±0.1	16.0±0.3	5.4	0.4