

PLEASE CHECK WWW.MOLEX.COM FOR LATEST PART INFORMATION

Part Number: [44300-0800](#)
Status: **Active**
Overview: Micro-Fit 3.0™ Connectors
Description: Micro-Fit 3.0 BMI™ Plug Housing, Dual Row, Panel Mount, 8 Circuits

Documents:

3D Model	Test Summary TS-44300-001 (PDF)
Drawing (PDF)	RoHS Certificate of Compliance (PDF)
Product Specification PS-44300-001 (PDF)	Product Literature (PDF)
Packaging Specification PK-44300-001 (PDF)	

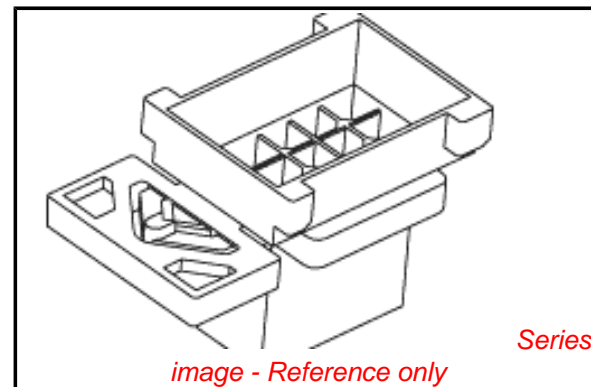

image - Reference only

Agency Certification

CSA	LR19980
TUV	R72081037
UL	E29179

General

Product Family	Crimp Housings
Series	44300
Application	Power, Wire-to-Board, Wire-to-Wire
Overview	Micro-Fit 3.0™ Connectors
Product Literature Order No	987650-5984
Product Name	Micro-Fit 3.0 BMI™
UPC	800754809672

Physical

Circuits (maximum)	8
Color - Resin	Black
Flammability	94V-0
Gender	Male
Glow-Wire Compliant	No
Material - Resin	Polyester
Net Weight	2.800/g
Number of Rows	2
Packaging Type	Bag
Panel Mount	Yes
Pitch - Mating Interface	3.00mm
Stackable	No
Temperature Range - Operating	-40°C to +105°C

Electrical

Current - Maximum per Contact	5A
-------------------------------	----

Material Info

Reference - Drawing Numbers

Packaging Specification	PK-44300-001
Product Specification	PS-44300-001, RPS-44300-001
Sales Drawing	SD-44300-001
Test Summary	TS-44300-001

EU RoHS ELV and RoHS Compliant REACH SVHC Contains SVHC: No Low-Halogen Status Not Low-Halogen	China RoHS 
---	--

Need more information on product environmental compliance?

Email productcompliance@molex.com
 For a multiple part number RoHS Certificate of Compliance, [click here](#)

Please visit the [Contact Us](#) section for any non-product compliance questions.

Search Parts in this Series

44300Series

Mates With

44133 , 44764 , 44769

Use With

43031