

FERROXCUBE

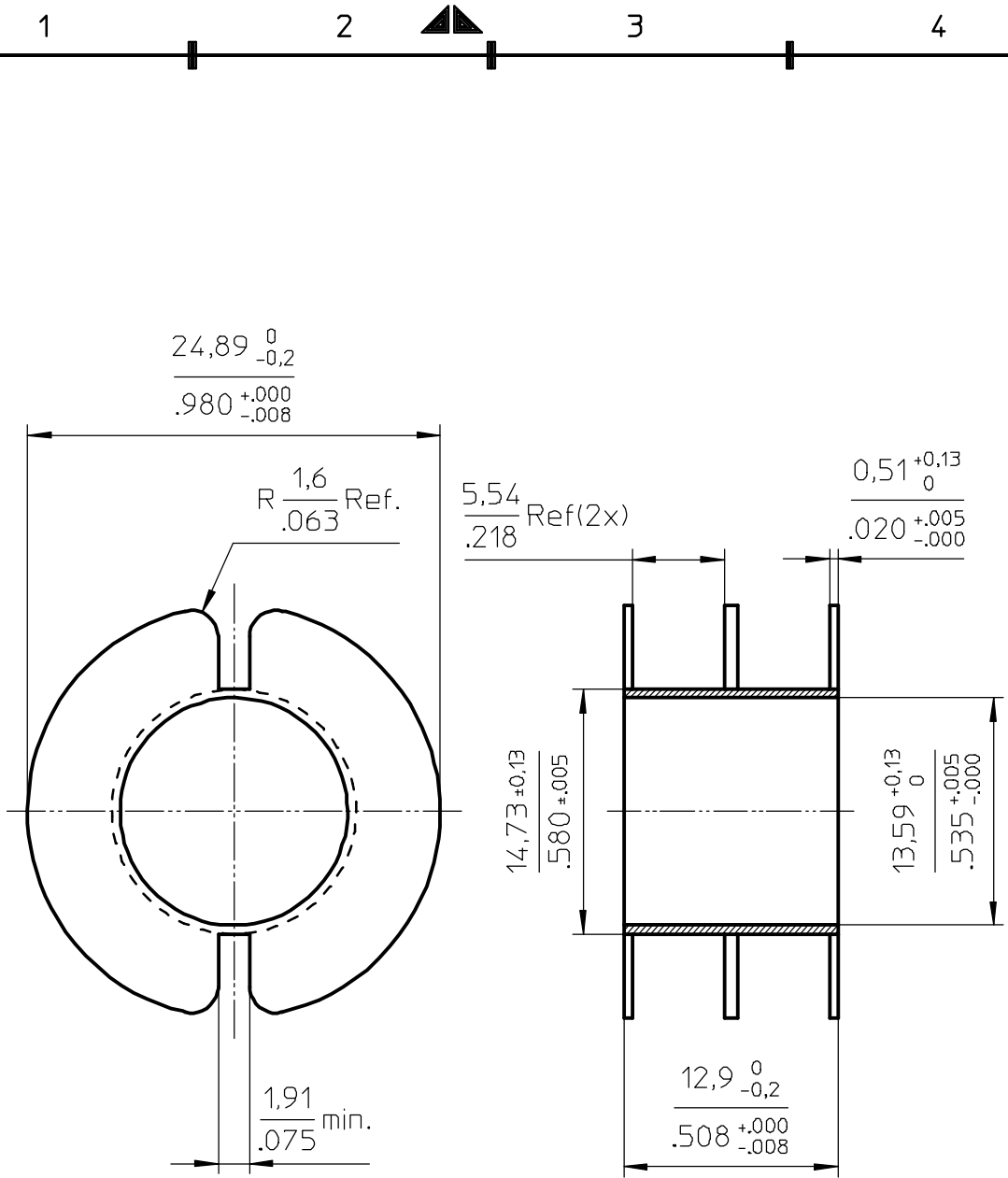
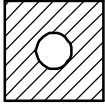

Coil former material: Delrin 900 (POM).
 UL file number: E66288 - UL94HB.
 max. operating temp: 130°

CLASSNO.			01-06-01
			02-11-04
	CP-P30/19-2S-A	4335 000 26241	
NAME NAAM	TJON	SUPERS. VERV	1 SH BL SH BL 112 - 001
MPA	CHECK CONTR.	DAT.	Property of Eigendom van © FERROXCUBE 2000
			A4