

# AS1346-49

## Dual Step-Down Converter with Battery Monitoring

### 1 General Description

The AS1346, AS1347, AS1348, AS1349 family is a high-efficiency, constant-frequency dual buck converter available with fixed voltage versions. The device provides two independent DC/DC Converters with output currents between 0.5A and 1.2A. The wide input voltage range (2.7V to 5.5V), automatic powersave mode and minimal external component requirements make the AS134x family perfect for SSD and many other battery-powered applications.

In shutdown mode the typical supply current decreases to  $\leq 1\mu\text{A}$ . The highly efficient duty cycle (100%) provides low dropout operation, prolonging battery life in portable systems.

An internal synchronous switching scheme increases efficiency and eliminates the need for an external Schottky diode. The fixed switching frequency (2.0MHz) allows the use of small surface mount inductors.

The integrated monitoring function can be configured that either the output voltage (Power Okay function) or the input voltage (Battery Monitoring Function) can be supervised.

Table 1. Available Products

Devices	IOUT1	IOUT2
AS1346	1.2A	0.5A
AS1347	0.5A	0.5A
AS1348	0.5A	0.95A
AS1349	1.2A	1.2A

The AS1346-49 is available in a 12-Pin TDFN 3x3mm package.

Figure 1. AS1346 - Typical Application Diagram with POK Function

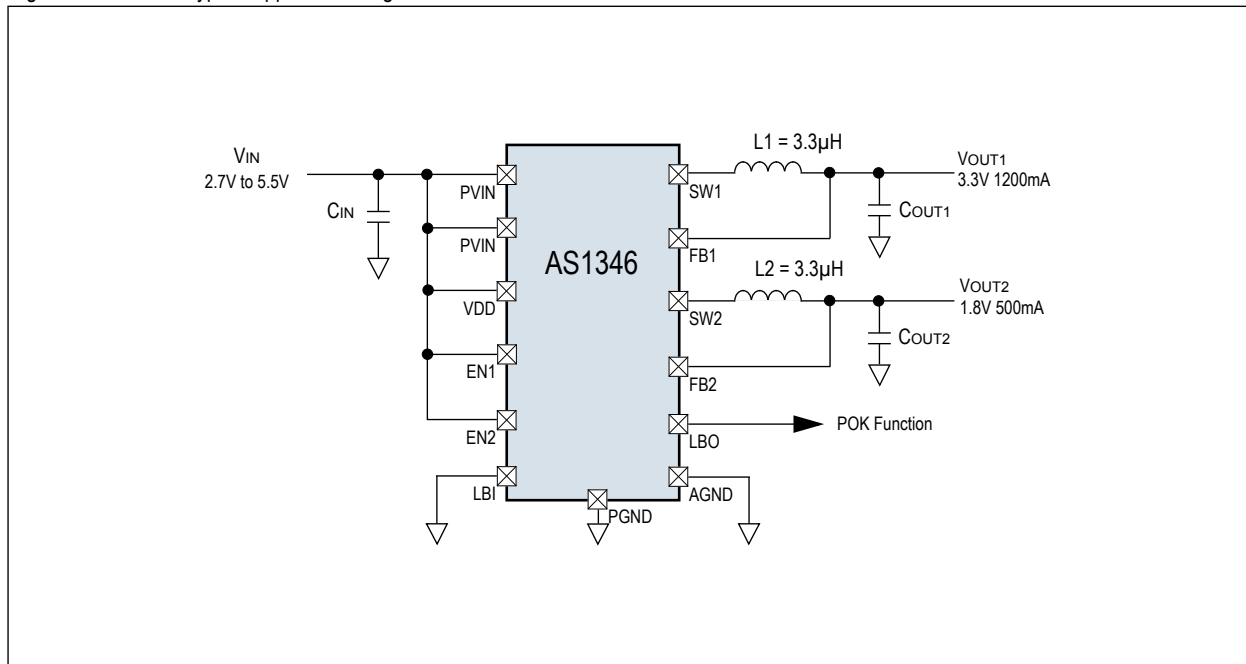

### 2 Key Features

- High Efficiency: Up to 95%
- Output Current: see Table 1
- Input Voltage Range: 2.7V to 5.5V
- Output Voltage Range: 1.2V to 3.6V (available in 100mV steps)
- Constant Frequency Operation: 2.0MHz
- 180° Out of Phase Operation
- Low Battery Detection
- Low Dropout Operation: 100% Duty Cycle
- Shutdown Mode Supply Current:  $\leq 1\mu\text{A}$
- No Schottky Diode Required
- Output Disconnect in Shutdown
- Non standard variants available within two weeks
- 12-Pin TDFN 3x3mm Package

### 3 Applications

The device is ideal for SSD applications, mobile communication devices, laptops and PDAs, ultra-low-power systems, threshold detectors/discriminators, telemetry and remote systems, medical instruments, or any other space-limited application with low power-consumption requirements.



## 4 Pin Assignments

Figure 2. Pin Assignments (Top View)

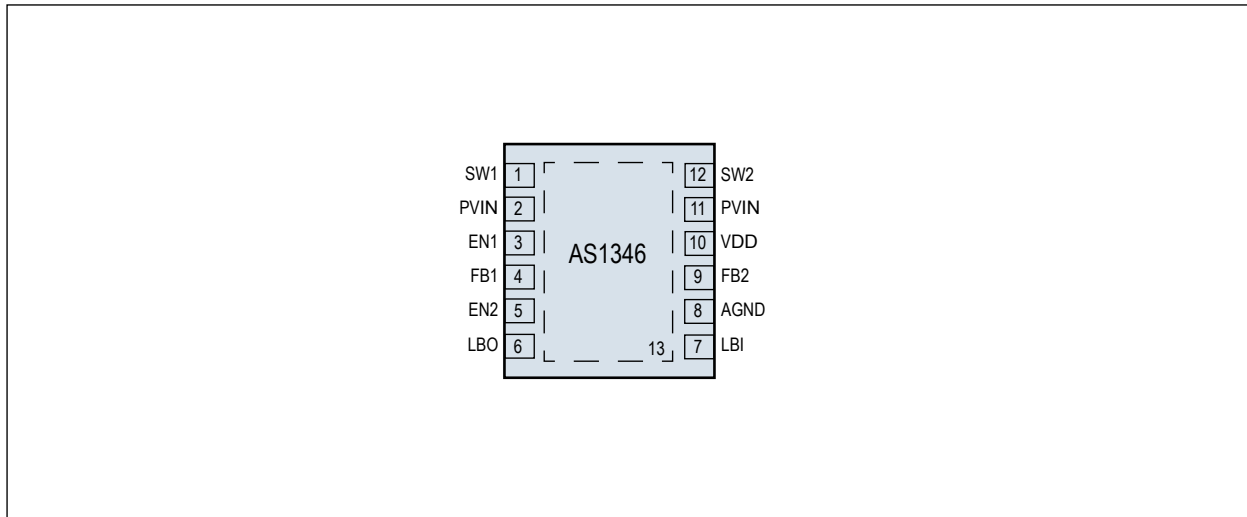

### 4.1 Pin Descriptions

Table 2. Pin Descriptions

Pin Number	Pin Name	Description
1	SW1	Switch Node1 Connection to Inductor. This pin connects to the drains of the internal main and synchronous power MOSFET switches.
2, 11	PVIN	Power Supply Connector. This pin must be closely decoupled to PGND with a $\geq 4.7\mu\text{F}$ ceramic capacitor.
3	EN1	Enable1 Input. Driving this pin above 1.2V enables $V_{\text{OUT}1}$ . Driving this pin below 0.5V puts the device in shutdown mode. In shutdown mode all functions are disabled, drawing $\leq 1\mu\text{A}$ supply current. This pin should not be left floating.
4	FB1	Feedback Pin 1. Feedback input to the error amplifier, connect this pin to $V_{\text{OUT}1}$ . The output can be factory set from 1.2V to 3.6V. For further information see <a href="#">Ordering Information on page 15</a> .
5	EN2	Enable2 Input. Driving this pin above 1.2V enables $V_{\text{OUT}2}$ . Driving this pin below 0.5V puts the device in shutdown mode. In shutdown mode all functions are disabled, drawing $\leq 1\mu\text{A}$ supply current. This pin should not be left floating.
6	LBO	Low Battery Comperator Output. This open-drain output is low when: - the voltage on LBI is higher than 1.2V or - LBI is connected to GND and $V_{\text{OUT}1}$ is below 92.5% of its nominal value.
7	LBI	Low Battery Comperator Input. 1.2V Threshold. May not be left floating. If connected to GND, LBO is working as Output Power Okay for $V_{\text{OUT}1}$ .
8	AGND	Analog Ground.
9	FB2	Feedback 2 Pin. Feedback input to the error amplifier, connect this pin to $V_{\text{OUT}2}$ . The output can be factory set from 1.2V to 3.6V. For further information see <a href="#">Ordering Information on page 15</a> .
10	VDD	Supply Connector. Connect this pin to PVIN
12	SW2	Switch Node2 Connection to Inductor. This pin connects to the drains of the internal main and synchronous power MOSFET switches.
13	PGND	Exposed Pad. The exposed pad must be connected to AGND. Ensure a good electrical connection to the PCB to achieve optimal thermal performance.



## 5 Absolute Maximum Ratings

Stresses beyond those listed in Table 3 may cause permanent damage to the device. These are stress ratings only, and functional operation of the device at these or any other conditions beyond those indicated in Electrical Characteristics on page 4 is not implied. Exposure to absolute maximum rating conditions for extended periods may affect device reliability.

Table 3. Absolute Maximum Ratings

Parameter	Min	Max	Units	Notes
Electrical Parameters				
VDD, PVIN to AGND	-0.3	+7.0	V	
PGND to AGND	-0.3	+0.3	V	
EN, FB	AGND - 0.3	VDD + 0.3	V	7.0V max
SW	PGND - 0.3	PVIN + 0.3	V	
PVIN to VDD	-0.3	+0.3	V	
Electrostatic Discharge				
Human Body Model		1	kV	Norm: MIL 883 E method 3015
Temperature Ranges and Storage Conditions				
Junction Temperature (T <sub>J-MAX</sub> )		+150	°C	
Storage Temperature Range	-55	+150	°C	
Package Body Temperature		+260	°C	The reflow peak soldering temperature (body temperature) specified is in accordance with IPC/JEDEC J-STD-020 "Moisture/Reflow Sensitivity Classification for Non-Hermetic Solid State Surface Mount Devices". The lead finish for Pb-free leaded packages is matte tin (100% Sn).
Humidity non-condensing	5	85	%	
Moisture Sensitive Level		1		Represents a max. floor life time of unlimited



## 6 Electrical Characteristics

PVIN = VDD = EN = 5V, unless otherwise noted. Typical values are at TA=25°C. All limits are guaranteed. The parameters with min and max values are guaranteed with production tests or SQC (Statistical Quality Control) methods.

Table 4. Electrical Characteristics

Symbol	Parameter	Conditions	Min	Typ	Max	Units
TA	Operating Temperature Range		-40		+85	°C
TJ	Operating Junction Temperature Range		-40		+125	°C
VIN	Input Voltage Range	VIN ≥ VOUT	2.7		5.5	V
VOUT	Output Voltage Range	(see Table 8 on page 15)	1.2		3.6	V
IQ	Quiescent Supply Current <sup>1</sup>			2	2.8	mA
IOUT1	Output current 1	AS1346, VOUT1 = 3.3V		1200		mA
		AS1347		500		mA
		AS1348		500		mA
		AS1349		1200		mA
IOUT2	Output current 2	AS1346, VOUT2 = 1.8V		500		mA
		AS1347		500		mA
		AS1348		950		mA
		AS1349		1200		mA
ISHDN	Shutdown Current			0.1	1	μA
Regulation						
VOUT1	Output Voltage 1	AS1346, IOUT1 = 100mA	3.234	3.3	3.366	V
	Accuracy			±2		%
VOUT2	Output Voltage 2	AS1346, IOUT2 = 100mA	1.764	1.8	1.836	V
	Accuracy			±2		%
	Line Transient Response	VIN = 4.5V to 5.5V, IOUT1 = 500mA, VOUT1 = 3.3V, EN2 = 0V		50		mVpk
	Load Transient Response	VIN = 5V, IOUT1 = 0 to 500mA, VOUT1 = 3.3V, EN2 = 0V		50		mVpk
fOSC	Oscillator frequency		1.8	2	2.2	MHz
ton	Turn on time			350		μs
DC-DC Switches						
ISW1	SW1 Current Limit	AS1346		1.55		A
ISW2	SW2 Current Limit	AS1346		800		mA
RDSO1(P)	Pin-Pin Resistance for PMOS1	VDD = 5.0V, ISW = 200mA		150		mΩ
RDSO1(N)	Pin-Pin Resistance for NMOS1	VDD = 5.0V, ISW = 200mA		250		mΩ



Table 4. Electrical Characteristics

Symbol	Parameter	Conditions	Min	Typ	Max	Units
$R_{DSON2(P)}$	Pin-Pin Resistance for PMOS2	$V_{DD} = 5.0V, I_{SW} = 200mA$		150		$m\Omega$
$R_{DSON2(N)}$	Pin-Pin Resistance for NMOS2	$V_{DD} = 5.0V, I_{SW} = 200mA$		250		$m\Omega$
Enable						
$V_{IH,EN}$	Logic high input threshold		1.2			V
$V_{IH,EN}$	Logic low input threshold				0.5V	V
Low Battery & Power-OK						
$V_{LBI}$	LBI Threshold	Falling Edge	1.16	1.2	1.24	V
	LBI Hysteresis			10		mV
	LBI Leakage Current	$LBI = 5V, T_A = 25^\circ C$		1		nA
	LBO Voltage Low <sup>2</sup>	$I_{LBO} = 0.1mA$		0.05		V
	LBO Leakage Current	$LBO = 5V, T_A = 25^\circ C$		1		nA
	Power-OK Threshold	$LBI = 0V, \text{Falling Edge}$	85	88	90	%

- The dynamic supply current is higher due to the gate charge delivered at the switching frequency. The Quiescent Current is measured while the DC-DC Converter is not switching.
- LBO goes low in startup mode as well as during normal operation if,
  - The voltage at the LBI pin is higher than LBI threshold.
  - The voltage at the LBI pin is below 0.1V (connected to GND) and  $V_{OUT1}$  is below 92.5% of its nominal value.



## 7 Typical Operating Characteristics

Figure 3. AS1346 Efficiency vs.  $I_{OUT}$ ,  $V_{OUT1} = 3.3V$

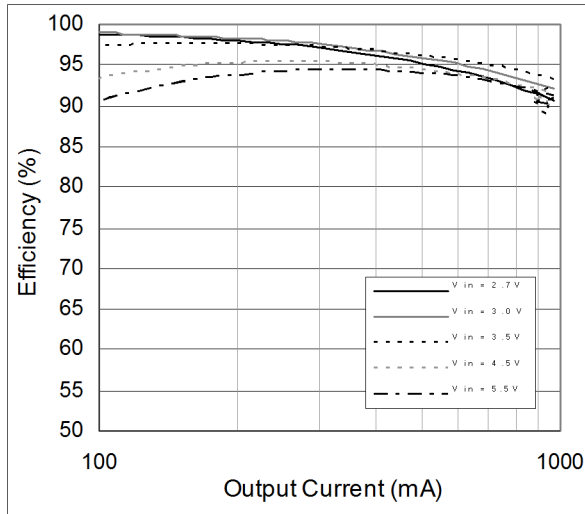

Figure 4. AS1346 Efficiency vs.  $I_{OUT}$ ,  $V_{OUT2} = 1.8V$

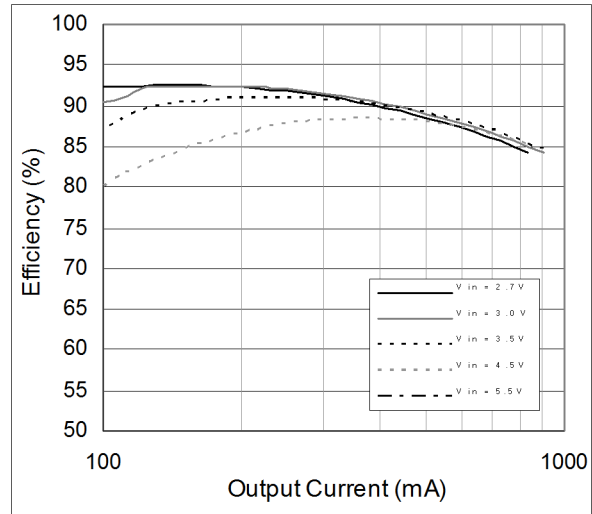

Figure 5. AS1346 Efficiency vs.  $V_{IN}$ ,  $V_{OUT1} = 3.3V$

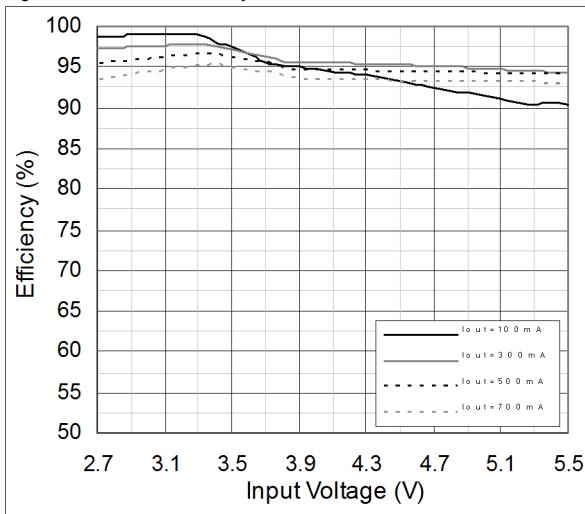

Figure 6. AS1346 Efficiency vs.  $V_{IN}$ ,  $V_{OUT2} = 1.8V$

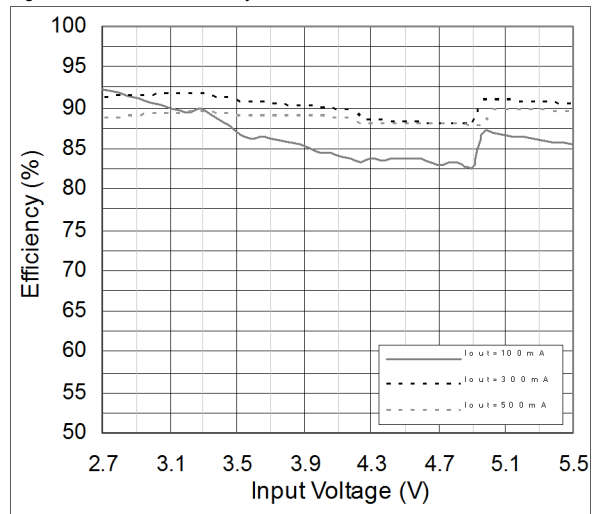

Figure 7. Efficiency vs.  $I_{OUT}$ ,  $V_{OUT1} = 2.5V$

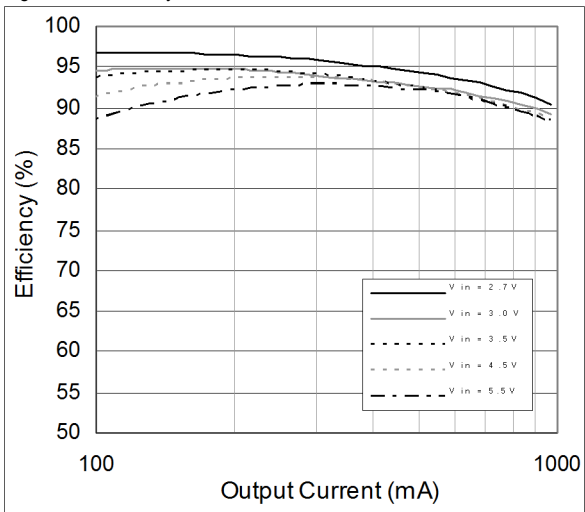

Figure 8. Efficiency vs.  $I_{OUT}$ ,  $V_{OUT2} = 1.2V$

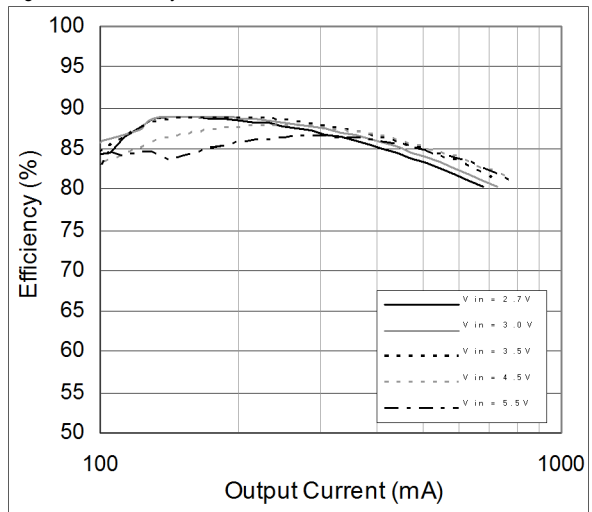



Figure 9. AS1346 Load Regulation;  $V_{IN} = 4.0V$ ,  $V_{OUT1} = 3.3V$

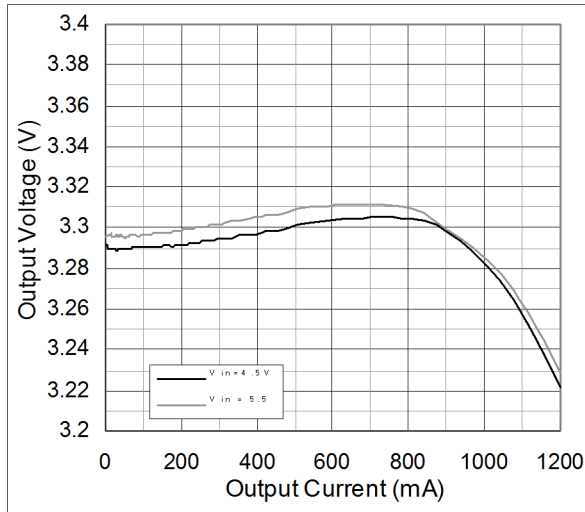

Figure 10. AS1346 Load Regulation;  $V_{IN} = 4.0V$ ,  $V_{OUT2} = 1.8V$

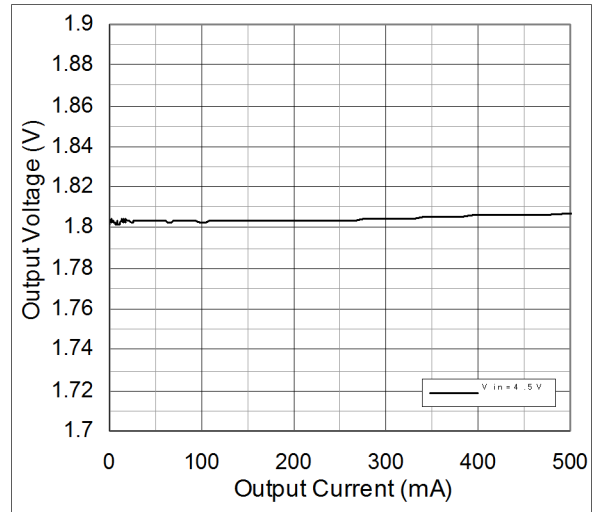

Figure 11. AS1346 Line Regulation,  $V_{OUT1} = 3.3V$

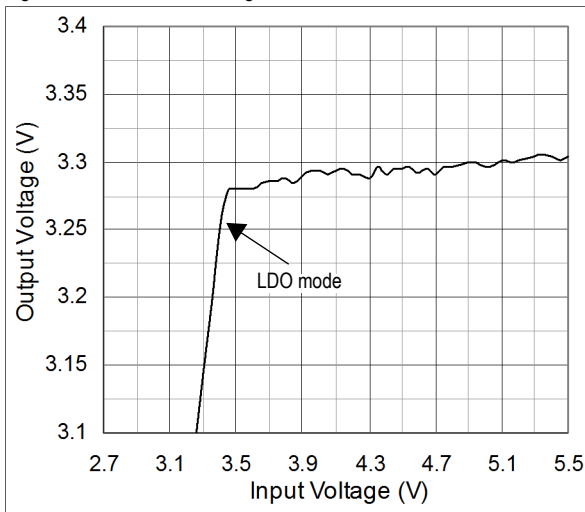

Figure 12. AS1346 Line Regulation,  $V_{OUT2} = 1.8V$

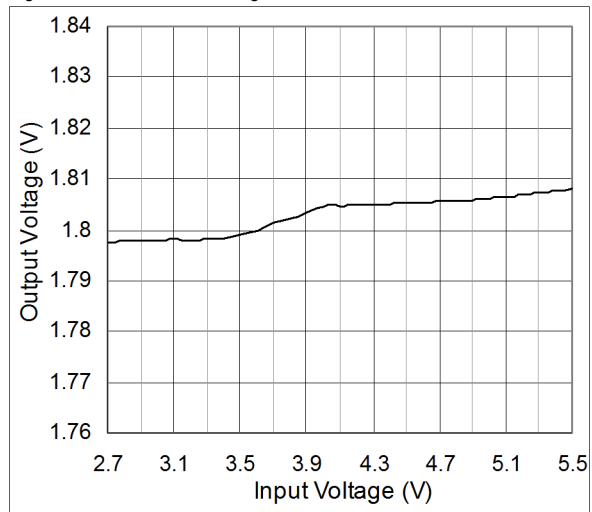

Figure 13. AS1346  $V_{OUT}$  vs. Temp.;  $V_{IN} = 5.5V$ ,  $I_{OUT} = 1A$

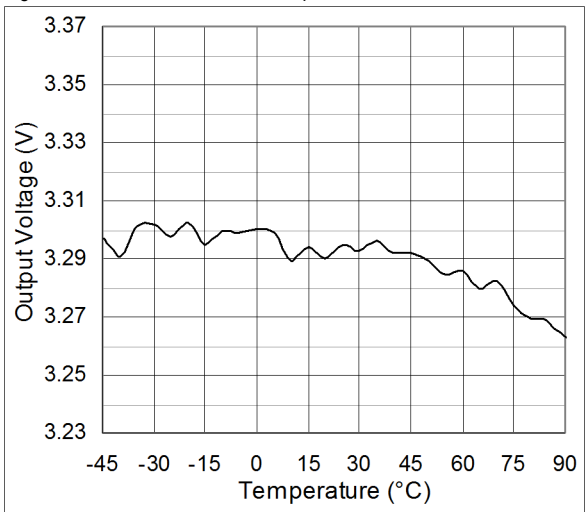

Figure 14. AS1346  $V_{OUT}$  vs. Temp.;  $V_{IN} = 5.5V$ ,  $I_{OUT} = 500mA$

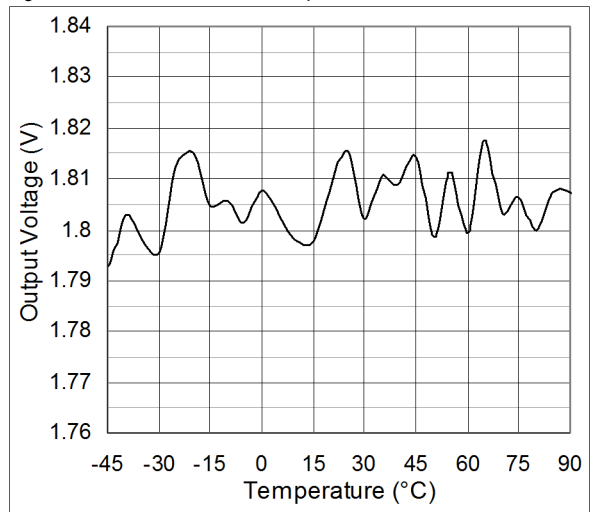



Figure 15. AS1346  $I_Q$  vs.  $V_{IN}$

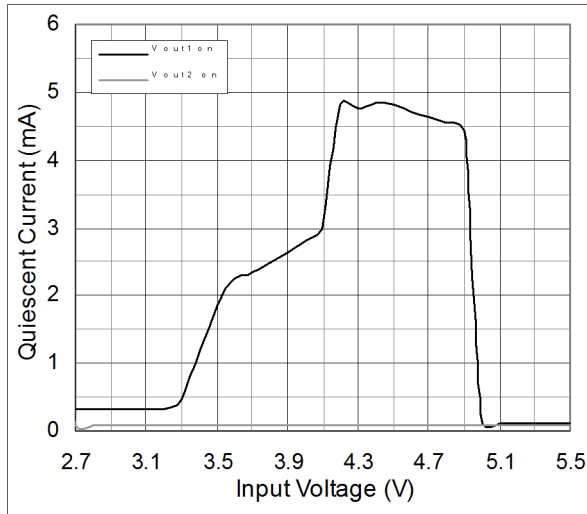
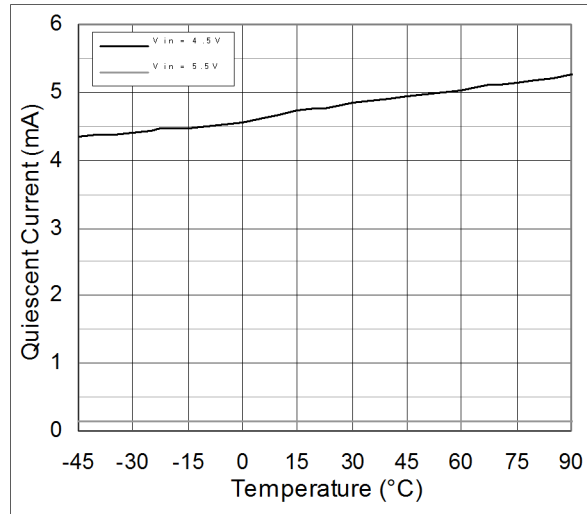

Figure 16. AS1346  $I_Q$  vs.  $V_{IN}$ , both  $V_{OUT}$  enabled







## 8 Detailed Description

The AS1346, AS1347, AS1348, AS1349 family is a high-efficiency buck converter that uses a constant-frequency current-mode architecture. The device contains two internal MOSFET switches and is available with a fixed output voltage (see Ordering Information on page 15).

Figure 17. AS1346 - Block Diagram

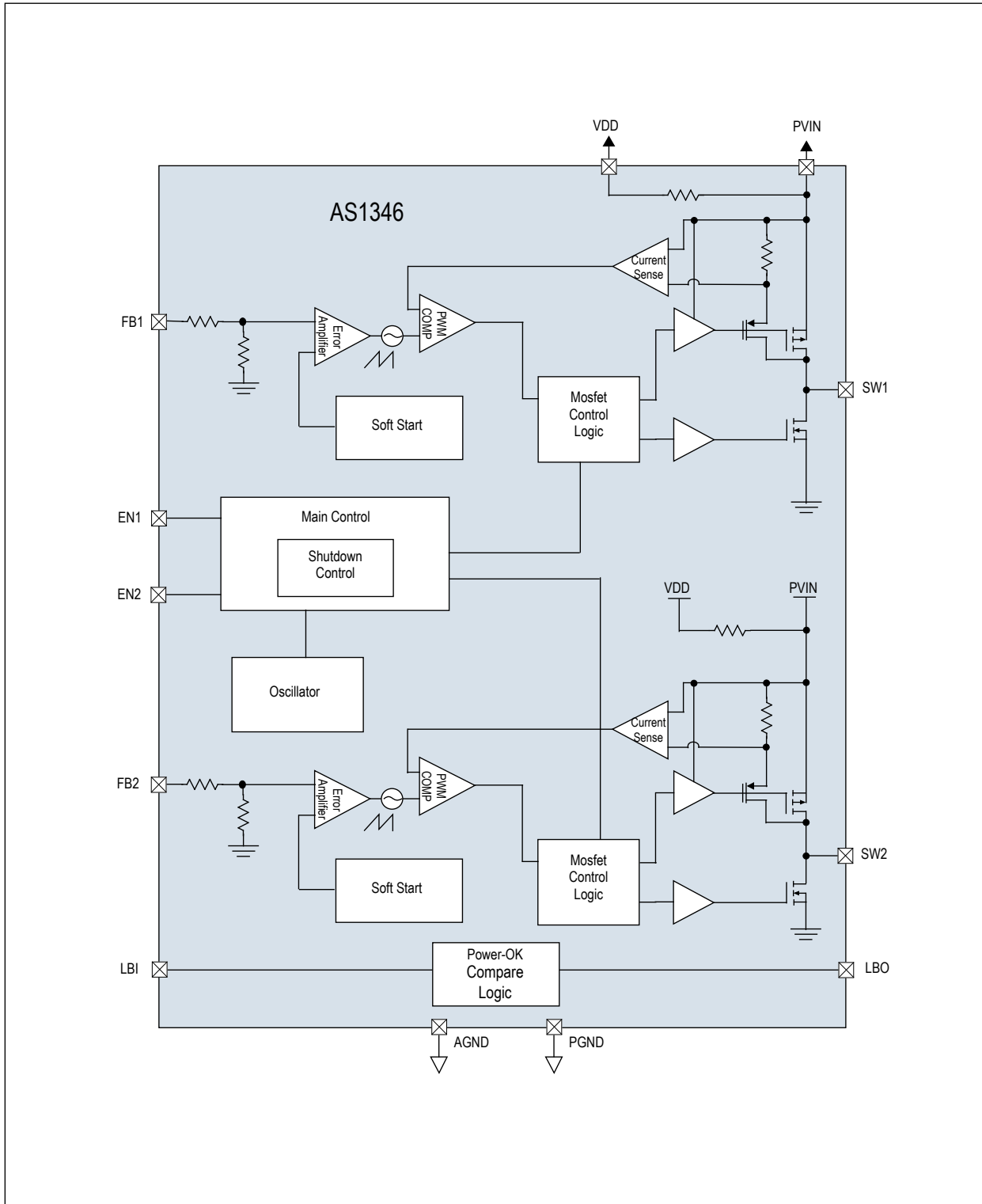



## 8.1 Main Control Loop

During normal operation, the internal top power MOSFET is turned on each cycle when the oscillator sets the RS latch. This switch is turned off when the current comparator resets the RS latch. The peak inductor current (I<sub>PK</sub>) at which ICOMP resets the RS latch, is controlled by the error amplifier. When I<sub>LOAD</sub> increases, V<sub>FB</sub> decreases slightly relative to the internal 0.6V reference, causing the error amplifier's output voltage to increase until the average inductor current matches the new load current.

When the top MOSFET is off, the bottom MOSFET is turned on until the inductor current starts to reverse as indicated by the current reversal comparator, or the next clock cycle begins. The over-voltage detection comparator guards against transient overshoots >7.8% by turning the main switch off and keeping it off until the transient is removed.

## 8.2 Short-Circuit Protection

The short-circuit protection turns off the power switches as long as the short is applied. When the short is removed the device is continuing normal operation.

## 8.3 Dropout Operation

The AS1346, AS1347, AS1348, AS1349 is working with a low input-to-output voltage difference by operating at 100% duty cycle. In this state, the PMOS is always on. This is particularly useful in battery-powered applications with a 3.3V output.

The AS1346, AS1347, AS1348, AS1349 allows the output to follow the input battery voltage as it drops below the regulation voltage. The quiescent current in this state is reduced to a minimal value, which aids in extending battery life. This dropout (100% duty-cycle) operation achieves long battery life by taking full advantage of the entire battery range.

The input voltage requires maintaining regulation and is a function of the output voltage and the load. The difference between the minimum input voltage and the output voltage is called the dropout voltage. The dropout voltage is therefore a function of the on-resistance of the internal PMOS (R<sub>DS(ON)PMOS</sub>) and the inductor resistance (DCR) and this is proportional to the load current.

**Note:** At low V<sub>IN</sub> values, the R<sub>DS(ON)</sub> of the P-channel switch increases (see [Electrical Characteristics on page 4](#)). Therefore, power dissipation should be taken in consideration.

## 8.4 Shutdown

Connecting EN to GND or logic low places the AS1346, AS1347, AS1348, AS1349 in shutdown mode and reduces the supply current to 0.1μA. In shutdown the control circuitry and the internal NMOS and PMOS turn off and SW becomes high impedance disconnecting the input from the output. The output capacitance and load current determine the voltage decay rate. For normal operation connect EN to V<sub>IN</sub> or logic high.

**Note:** Pin EN should not be left floating.

### 8.4.1 Power-OK and Low-Battery-Detect Functionality

LBO goes low in startup mode as well as during normal operation if,

- The voltage at the LBI pin is above LBI threshold (1.2V). This can be used to monitor the battery voltage.
- LBI pin is connected to GND and V<sub>OUT1</sub> is below 92.5% of its nominal value. LBO works as a power-OK signal in this case.

The LBI pin can be connected to a resistive-divider to monitor a particular definable voltage and compare it with a 1.2V internal reference. If LBI is connected to GND (see [Figure 1 on page 1](#)) an internal resistive-divider is activated and connected to the output. Therefore, the Power-OK functionality can be realized with no additional external components.

The Power-OK feature is not active during shutdown. To obtain a logic-level output, connect a pull-up resistor from pin LBO to pin V<sub>OUT</sub> or V<sub>DD</sub>. Larger values for this resistor will help to minimize current consumption; a 100kΩ resistor is perfect for most applications (see [Figure 18 on page 11](#)).

For the circuit shown in the left of [Figure 18 on page 11](#), the input bias current into LBI is very low, permitting large-value resistor-divider networks while maintaining accuracy. Place the resistor-divider network as close to the device as possible. Use a defined resistor for R<sub>2</sub> and then calculate R<sub>1</sub> as:

$$R_1 = R_2 \cdot \left( \frac{V_{IN}}{V_{LBI}} - 1 \right) \quad (\text{EQ 1})$$

**Where:**

V<sub>LBI</sub> (the internal sense reference voltage) is 1.2V.

In case of the LBI pin is connected to GND, an internal resistor-divider network is activated and compares the output voltage with a 92.5% voltage threshold (see [AS1346 - Typical Application Diagram with POK Function on page 1](#)). For this particular Power-OK application, no external resistive components (R<sub>1</sub> and R<sub>2</sub>) are necessary.



Figure 18. Typical Application Diagram with Adjustable Battery Monitoring

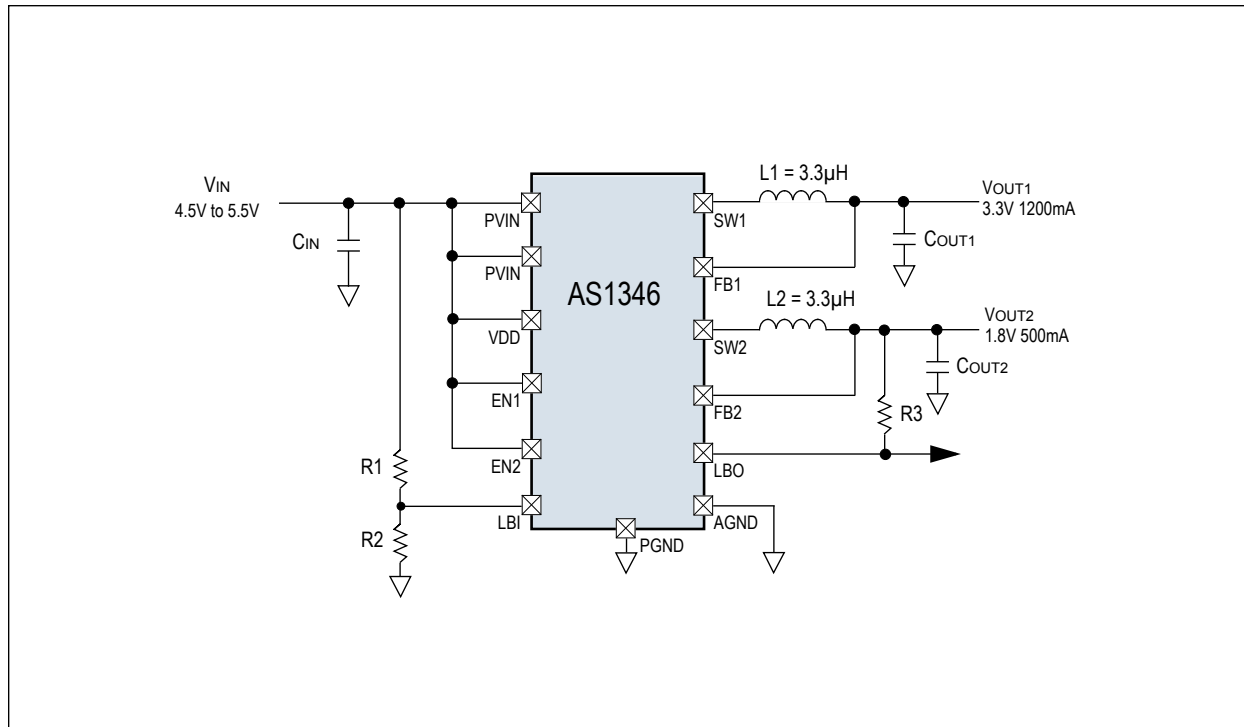

## 8.5 Thermal Shutdown

Due to its high-efficiency design, the AS1346 will not dissipate much heat in most applications. However, in applications where the AS1346 is running at high ambient temperature, uses a low supply voltage, and runs with high duty cycles (such as in dropout) the heat dissipated may exceed the maximum junction temperature of the device.

As soon as the junction temperature reaches approximately 150°C the AS1346 goes in thermal shutdown. In this mode the internal PMOS & NMOS switch are turned off. The device will power up again, as soon as the temperature falls below +140°C again.



## 9 Application Information

### 9.1 Component Selection

Only three power components are required to complete the design of the buck converter. For the adjustable LBI two external resistors are needed.

### 9.2 Inductor Selection

For the external inductor, a 3.3μH inductor is recommended. Minimum inductor size is dependant on the desired efficiency and output current. Inductors with low core losses and small DCR at 2MHz are recommended.

Table 5. Recommended Inductor

L	DCR	Current Rating
3.3μH	80mΩ	IMAX

Calculation of IMAX:

$$I_{MAX} = \frac{I_{OUT1} \times V_{OUT1} + I_{OUT2} \times V_{OUT2}}{0,7 \times V_{IN}} \quad (EQ 2)$$

### 9.3 Capacitor Selection

A 10μF capacitor is recommended for C<sub>IN</sub> as well as a 10μF for C<sub>OUT</sub>. Small-sized X5R or X7R ceramic capacitors are recommended as they retain capacitance over wide ranges of voltages and temperatures.

#### 9.3.1 Input and Output Capacitor Selection

Low ESR input capacitors reduce input switching noise and reduce the peak current drawn from the battery. Also low ESR capacitors should be used to minimize V<sub>OUT</sub> ripple. Multi-layer ceramic capacitors are recommended since they have extremely low ESR and are available in small footprints.

For input decoupling the ceramic capacitor should be located as close to the device as practical. A 22μF input capacitor is sufficient for most applications. Larger values may be used without limitations.

A 2.2μF to 10μF output ceramic capacitor is sufficient for most applications. Larger values up to 22μF may be used to obtain extremely low output voltage ripple and improve transient response.

Table 6. Recommended Input and Output Capacitor

	C	TC Code	Rated Voltage
C <sub>IN</sub>	10 - 47μF	X5R	6.3V
C <sub>OUT1</sub> , C <sub>OUT2</sub>	2.2 - 10μF	X7R	25V



## 10 Package Drawings and Markings

Figure 19. 12-Pin TDFN 3x3mm Marking

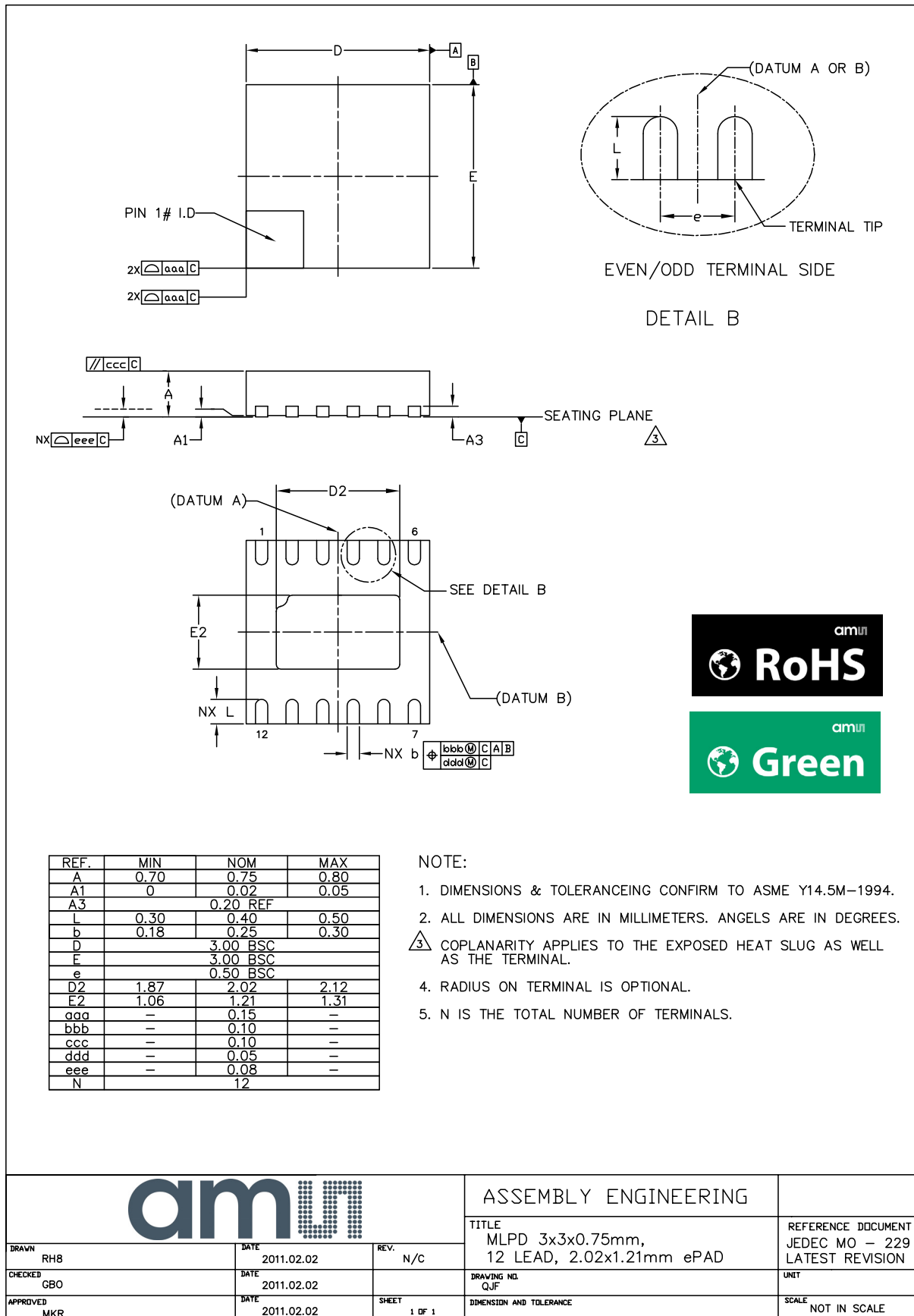

Table 7. Packaging Code YYWWQZZ

XXXX	YY	WW	Q	ZZ
marketing code	year	manufacturing week	plant identifier	free choice / traceability code



Figure 20. 12-Pin TDFN 3x3mm Package



			ASSEMBLY ENGINEERING		
			TITLE MLPD 3x3x0.75mm, 12 LEAD, 2.02x1.21mm ePAD		REFERENCE DOCUMENT JEDEC MO - 229 LATEST REVISION
DRAWN RHS	DATE 2011.02.02	REV. N/C	DRAWING NO. QJF		UNIT
CHECKED GBO	DATE 2011.02.02		DIMENSION AND TOLERANCE		SCALE NOT IN SCALE
APPROVED MKR	DATE 2011.02.02	SHEET 1 OF 1			



## 11 Ordering Information

The device is available as the standard products listed below.

Table 8. Ordering Information

Ordering Code	Marking	Channel	Vout	Iout	Description	Delivery Form	Package
AS1346-BTDT-3318	ASSL	OUT1	3.3V	1.2A	Dual Step-Down Converter with Battery Monitoring	Tape and Reel	12-Pin TDFN 3x3mm
		OUT2	1.8V	0.5A			
AS1347-BTDT-1812	ASU6	OUT1	1.8V	0.5A	Dual Step-Down Converter with Battery Monitoring	Tape and Reel	12-Pin TDFN 3x3mm
		OUT2	1.2V	0.5A			
AS1347-BTDT-3310	ASU7	OUT1	3.3V	0.5A	Dual Step-Down Converter with Battery Monitoring	Tape and Reel	12-Pin TDFN 3x3mm
		OUT2	1.0V	0.5A			
AS1348-BTDT-3312	ASTZ	OUT1	3.3V	0.5A	Dual Step-Down Converter with Battery Monitoring	Tape and Reel	12-Pin TDFN 3x3mm
		OUT2	1.2V	0.95A			
AS1346-BTDT-xyy <sup>1</sup>	tbd	OUT1	xx	1.2A	Dual Step-Down Converter with Battery Monitoring	Tape and Reel	12-Pin TDFN 3x3mm
		OUT2	yy	0.5A			
AS1347-BTDTxyy <sup>1</sup>	tbd	OUT1	xx	0.5A	Dual Step-Down Converter with Battery Monitoring	Tape and Reel	12-Pin TDFN 3x3mm
		OUT2	yy	0.5A			
AS1348-BTDTxyy <sup>1</sup>	tbd	OUT1	xx	0.5A	Dual Step-Down Converter with Battery Monitoring	Tape and Reel	12-Pin TDFN 3x3mm
		OUT2	yy	0.95A			
AS1349-BTDTxyy <sup>1</sup>	tbd	OUT1	xx	1.2A	Dual Step-Down Converter with Battery Monitoring	Tape and Reel	12-Pin TDFN 3x3mm
		OUT2	yy	1.2A			

1. Non-standard devices from 1.2V to 3.6V are available in 100mV steps.  
For more information and inquiries contact <http://www.ams.com/contact>

Receive samples within **2 weeks** for any non standard output voltage variant!

**Note:** All products are RoHS compliant.  
Buy our products or get free samples online at ICdirect: <http://www.ams.com/ICdirect>

Technical Support is found at <http://www.ams.com/Technical-Support>

For further information and requests, please contact us <mailto:sales@ams.com>  
or find your local distributor at <http://www.ams.com/distributor>



## Copyrights

Copyright © 1997-2011, ams AG, Tobelbaderstrasse 30, 8141 Unterpremstaetten, Austria-Europe. Trademarks Registered ®. All rights reserved. The material herein may not be reproduced, adapted, merged, translated, stored, or used without the prior written consent of the copyright owner.

All products and companies mentioned are trademarks or registered trademarks of their respective companies.

## Disclaimer

Devices sold by ams AG are covered by the warranty and patent indemnification provisions appearing in its Term of Sale. ams AG makes no warranty, express, statutory, implied, or by description regarding the information set forth herein or regarding the freedom of the described devices from patent infringement. ams AG reserves the right to change specifications and prices at any time and without notice. Therefore, prior to designing this product into a system, it is necessary to check with ams AG for current information. This product is intended for use in normal commercial applications. Applications requiring extended temperature range, unusual environmental requirements, or high reliability applications, such as military, medical life-support or life-sustaining equipment are specifically not recommended without additional processing by ams AG for each application. For shipments of less than 100 parts the manufacturing flow might show deviations from the standard production flow, such as test flow or test location.

The information furnished here by ams AG is believed to be correct and accurate. However, ams AG shall not be liable to recipient or any third party for any damages, including but not limited to personal injury, property damage, loss of profits, loss of use, interruption of business or indirect, special, incidental or consequential damages, of any kind, in connection with or arising out of the furnishing, performance or use of the technical data herein. No obligation or liability to recipient or any third party shall arise or flow out of ams AG rendering of technical or other services.



## Contact Information

### Headquarters

ams AG  
Tobelbaderstrasse 30  
A-8141 Unterpremstaetten, Austria

Tel: +43 (0) 3136 500 0  
Fax: +43 (0) 3136 525 01

For Sales Offices, Distributors and Representatives, please visit:

<http://www.ams.com/contact>