



## Features

- u 120 Watts Peak Pulse Power per Line (tp=8/20μs)
- u Protects two or four I/O lines
- u Low capacitance: 0.35 pF typical (I/O to I/O)
- u Low operating voltage: 5V
- u RoHS Compliant
- u IEC61000-4-2 (ESD) ±25kV (air), ±20kV (contact)
- u IEC61000-4-4 (EFT) 40A (5/50ns)
- u IEC61000-4-5 (Lightning) 4A (8/20μs)

## Mechanical Characteristics

- u Package: DFN2510-10 (2.5×1.0×0.5mm)
- u Ultra low leakage: nA level
- u Case Material: “Green” Molding Compound.
- u UL Flammability Classification Rating 94V-0
- u Moisture Sensitivity: Level 3 per J-STD-020
- u Terminal Connections: See Diagram Below

## Applications

- u High Definition Multimedia Interface (HDMI)
- u Digital Visual Interface (DVI)
- u Unified Display Interface (UDI)
- u MDDI Ports
- u PCI Express
- u Serial ATA

## Ordering Information

Part Number	Qty per Reel	Reel Size
TPRCLAMP0524P	3000	7"

## Dimensions and Pin Configuration

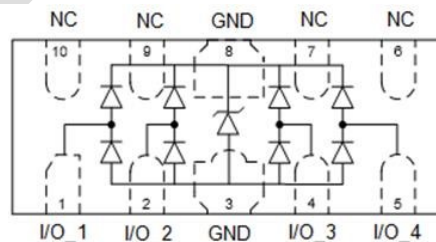

## Marking

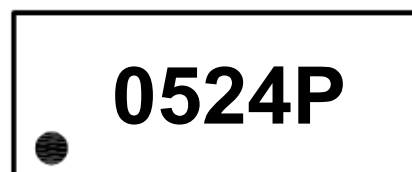

**Absolute Maximum Ratings** (Tamb=25°C unless otherwise specified)

Parameter	Symbol	Value	Unit
Peak Pulse Power (8/20μs)	Ppk	120	W
Peak Pulse Current (8/20μs)	IPP	4	A
ESD per IEC 61000-4-2 (Air)	VESD	± 25	kV
ESD per IEC 61000-4-2 (Contact)		± 20	
Operating Temperature Range	TJ	-55 to +125	°C
Storage Temperature Range	Tstg	-55 to +150	°C

**Electrical Characteristics** (TA=25°C unless otherwise specified)

Parameter	Symbol	Min	Typ	Max	Unit	Test Condition
Reverse Working Voltage	VRWM			5	V	Any I/O pin to ground
Breakdown Voltage	VBR	6		9	V	IT = 1mA, any I/O pin to ground
Reverse Leakage Current	IR			0.2	μA	VRWM = 5V, any I/O pin to ground
Clamping Voltage	VC			9	V	IPP = 1A (8 x 20μs pulse), any I/O pin to ground
Clamping Voltage	VC			25	V	IPP = 4A (8 x 20μs pulse), any I/O pin to ground
Junction Capacitance	CJ		0.35		pF	VR = 0V, f = 1MHz, between I/O pins
Junction Capacitance	CJ		0.6	0.8	pF	VR = 0V, f = 1MHz, any I/O pin to ground

## Characteristic Curves

Fig1. 8/20 $\mu$ s Pulse Waveform

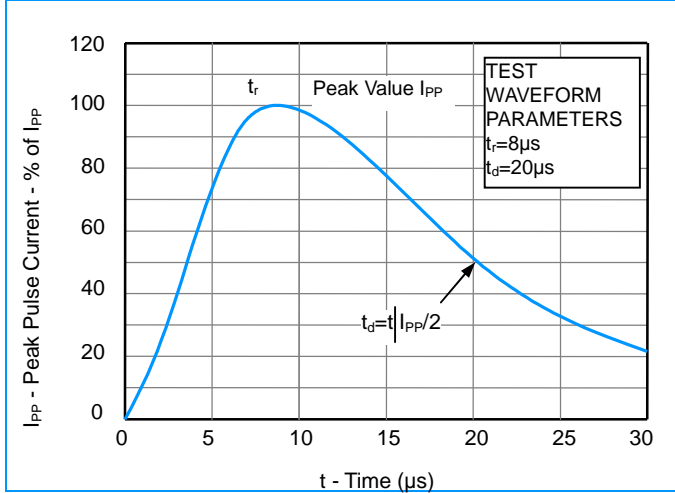

Fig2. ESD Pulse Waveform (according to IEC 61000-4-2)

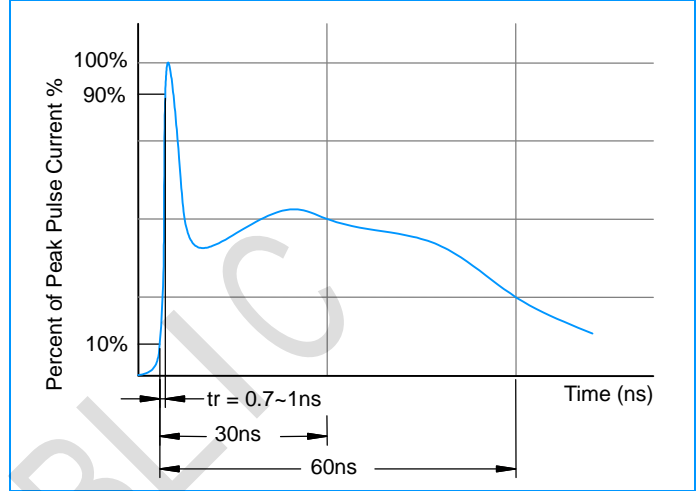

Fig3. Non - Repetitive Peak Pulse Power vs. Pulse Time

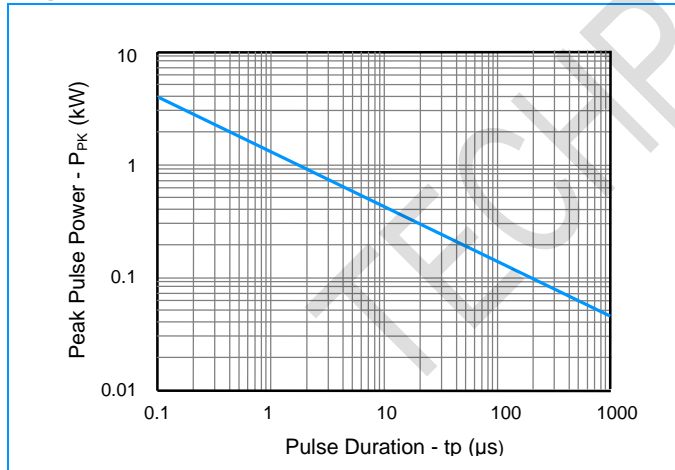
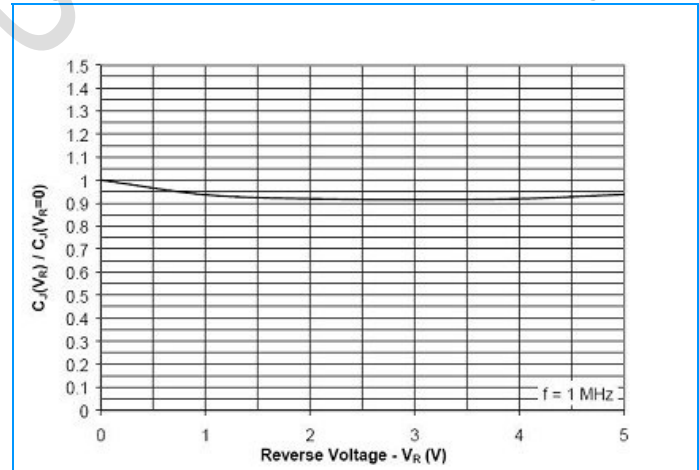
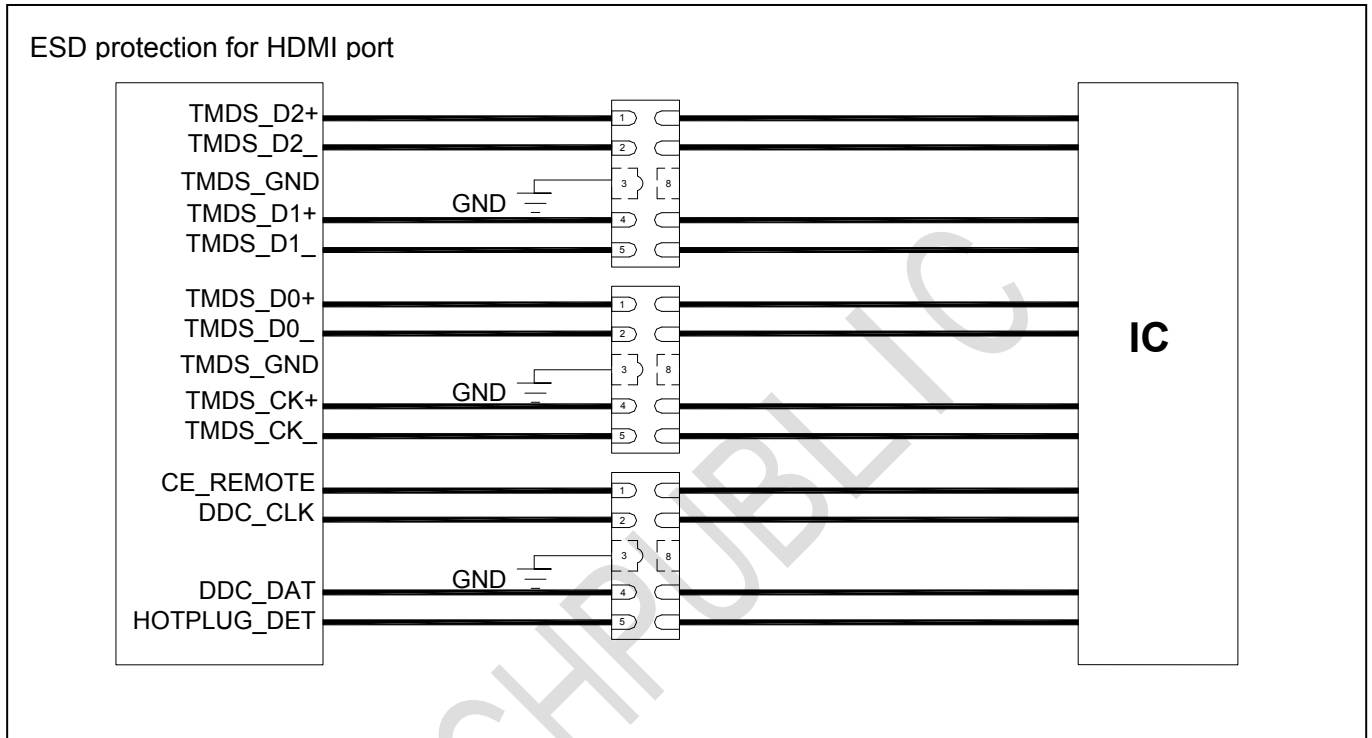

Fig4. Normalized Capacitance vs. Reverse Voltage



**Application Information**



## Outline Drawing - DFN2510-10

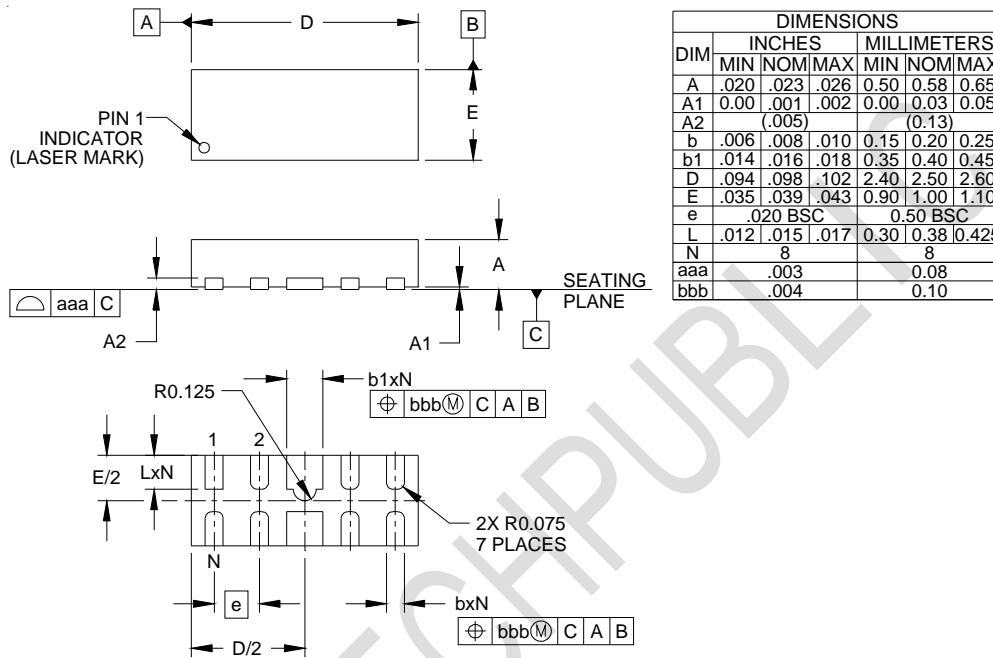

## Land Pattern - DFN2510-10

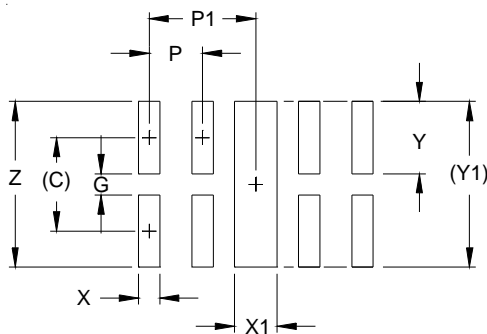

DIM	DIMENSIONS	
	INCHES	MILLIMETERS
C	(.034)	(0.875)
G	.008	0.20
P	.020	0.50
P1	.039	1.00
X	.008	0.20
X1	.016	0.40
Y	.027	0.675
Y1	(.061)	(1.55)
Z	.061	1.55