



High Performance BGA Cooling Solutions with maxiGRIP™ Attachment

ATS PART # ATS-53310P-C1-R0

Features & Benefits

- » High aspect ratio, straight fin heat sinks that are ideal for compact PCB environments
- » maxiGRIP™ attachment applies steady, even pressure to the component and does not require holes in the PCB
- » Designed specifically for BGAs and other surface mount packages
- » Meets Telcordia GR-63-Core Office Vibration, ETSI 300 019 Transportation Vibration, and MIL-STD-810 Shock testing and Unpackaged Drop Testing standards
- » Comes preassembled with high performance, phase change, thermal interface material
- » “Keep-Out” Requirements: An “Un-Populated” boarder zone of 5 mm around the component is necessary to facilitate the Installation/ Removal of the maxiGRIP™. Please refer to the maxiGRIP™ Keep-Out Guidelines and maxiGRIP™ Installation/Removal Instructions for further details

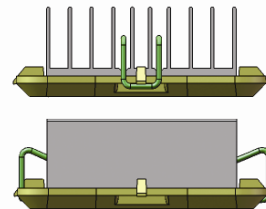
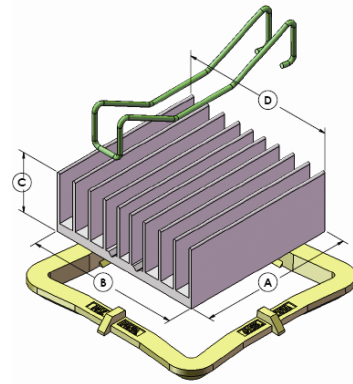

**Image above is for illustration purposes only.*

Thermal Performance

AIR VELOCITY		THERMAL RESISTANCE	
FT/MIN	M/S	°C/W (UNDUCTED FLOW)	°C/W (DUCTED FLOW)
200	1.0	4.7	3.1
300	1.5	3.8	
400	2.0	3.3	
500	2.5	2.9	
600	3.0	2.7	
700	3.5	2.5	
800	4.0	2.4	

Product Details

DIMENSION A	DIMENSION B	DIMENSION C	DIMENSION D	INTERFACE MATERIAL	FINISH
31 mm	31 mm	17.5 mm	31 mm	CHOMERICS T766	BLUE ANODIZED

NOTES:

- 1) DIMENSIONS ARE MEASURED IN MILLIMETERS
- 2) DIMENSIONS A & B REFER TO COMPONENT SIZE
- 3) DIMENSION C = THE HEIGHT OF THE HEAT SINK SHOWN ABOVE AND DOES NOT INCLUDE THE HEIGHT OF THE ATTACHMENT METHOD
- 4) ATS RESERVES THE RIGHT TO UPDATE OR CHANGE IT PRODUCTS WITHOUT NOTICE
- 5) CONTACT ATS TO LEARN ABOUT CUSTOM OPTIONS AVAILABLE



ATS ADVANCED THERMAL SOLUTIONS, INC.
Innovations in Thermal Management®

For more information, to find a distributor or to place an order, visit www.qats.com or call: 781.769.2800 (North America); +31 (0) 3569 84715 (Europe).