

36

3615-1

RAST 5 connectors, pitch 5.0 mm

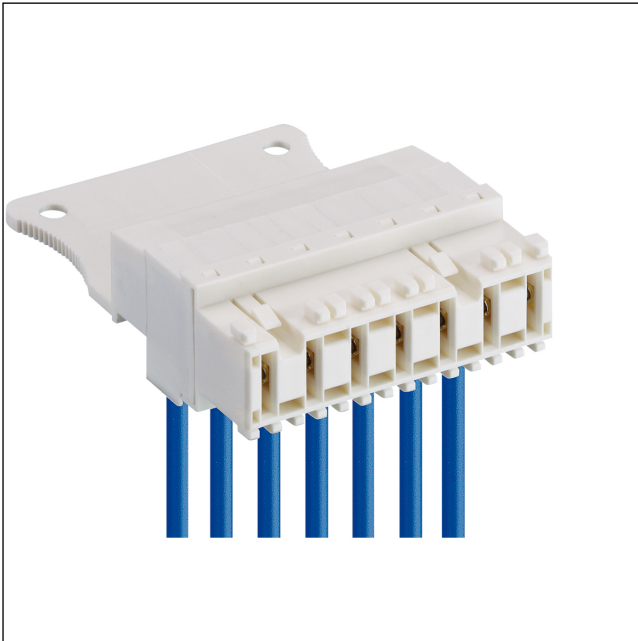

RAST 5 connector for indirect mating, with screw terminal, with lift clamp with protection against misplacing, with test holes and interior locking, consecutive placement without loss of pitch, cable departure opposite to lock, with handle latch

---

State: Active

---

Approvals:  

---

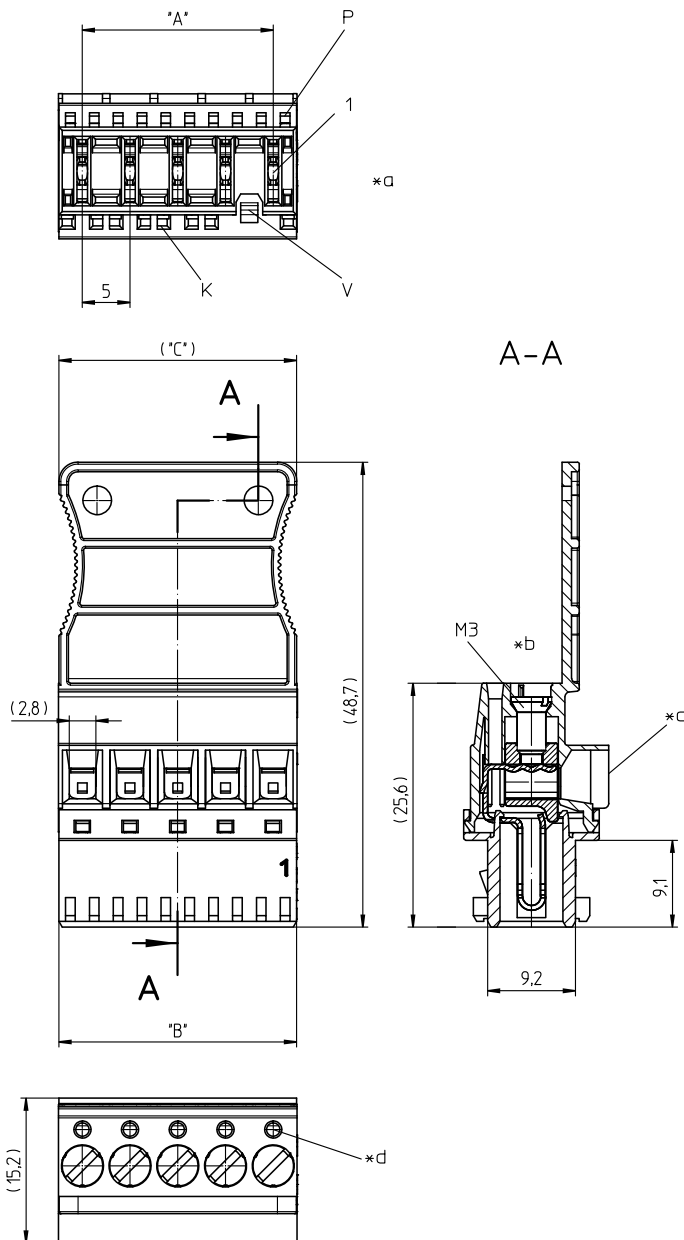

- \*a K = keying  
P = positioning  
V = space for lock
- \*b all screw clamps of the connector to be tightened with the indicated torque
- \*c cable departure 90°
- \*d hole for test spike  $\varnothing$  1.3 mm

### Environmental conditions

Temperature range -25 °C/+130 °C<sup>1</sup>

<sup>1</sup> upper limit temperature (insulating body) RTI (electrical) of the UL Yellow Card

### Materials

Insulating body PA GF, V-2 according to UL94<sup>1</sup>  
 Contact spring CuSn, tin-plated  
 Clamp CuZn, nickel-plated  
 Screw steel, zinc-plated and chromatiert

<sup>1</sup> component glow wire resistant (GWT 750 °C), testing acc. to IEC 60695-2-11, assessment acc. to IEC 60335-1 (flame < 2 s)

### Mechanical data

Insertion force/contact  $\leq$  4,0 N  
 Withdrawal force/contact  $\geq$  1,0 N  
 Tightening torque screw 0,5 Nm  
 Keying proposals at [www.lumberg.com](http://www.lumberg.com) 

### Connectable conductors for screw clamp



















Section stranded wire 0,14–2,5 mm<sup>2</sup> (AWG 26–14)  
 Section stranded wire with sleeve 0,25–2,5 mm<sup>2</sup> (AWG 24–14)  
 Section solid wire 0,14–4,0 mm<sup>2</sup> (AWG 26–12)  
 Stripping length 8 ± 1 mm

### Electrical data (at T<sub>amb</sub> 20 °C)

Contact resistance  $\leq$  5 m $\Omega$   
 Rated current 10 A (T<sub>v</sub> 70 °C)  
 Rated voltage 250 V AC  
 Material group IIIa (IEC)/2 (UL) (CTI  $\geq$  250)  
 Creepage distance 3,5 mm  
 Clearance 3,5 mm  
 Insulation resistance > 10 G $\Omega$

### Associated products

#### Counterparts

 3618	 3618-1	 3618-2
 3618-3	 361899	 361899-1
 361899-2	 361899-3	 3641
 3642	 364299	 3643
 364399	 3644	 364499
 3645	 364599	 3647

---

<a href="#">3648</a>	<a href="#">3649</a>	<a href="#">3671</a>
<a href="#">367199</a>	<a href="#">3672</a>	<a href="#">367299</a>
<a href="#">3673</a>	<a href="#">367399</a>	<a href="#">3674</a>
<a href="#">367499</a>	<a href="#">3676</a>	<a href="#">3677</a>
<a href="#">3678</a>	<a href="#">3679</a>	<a href="#">3680</a>
<a href="#">3683</a>		

---

36

3615-1

Designation	Pole Number	PU (Pieces)	MDQ (Pieces)	Dimensions		
				A (mm)	B (mm)	C (mm)
3615-1 02	2	200	1000	5	9.9	9.3
3615-1 03	3	200	1000	10	14.9	14.3
3615-1 04	4	200	1000	15	19.9	19.3
3615-1 05	5	200	1000	20	24.9	24.3
3615-1 06	6	200	1000	25	29.9	29.3
3615-1 07	7	200	1000	30	34.9	34.3

Designation to be completed by further details (e.g. for keying, color or material options).

**Packaging:**

in bulk, in a cardboard box