

1A Low Dropout, Fast Response Fixed Voltage Regulator

Features

- **Guaranteed Output Voltage Accuracy within 2%**
- **Fast Transient Response**
- **Load Regulation : 1mV Typ.**
- **Line Regulation : 4mV Typ.**
- **Low Dropout Voltage : 210mV at $I_{OUT}=1A$**
- **Current Limit : 1A Typ. at $T_j=125^\circ C$**
- **On-Chip Thermal Limiting : 150 $^\circ C$ Typ.**
- **Standard 8-pin SOP Power Package**
- **Very Low Shutdown Current : < 0.5mA**
- **Fixed Output Voltage : 2.5V, 2.8V and 3.3V**
- **Lead Free and Green Devices Available (RoHS Compliant)**

Applications

- Peripheral Cards
- Active SCSI Terminators
- Low Voltage Logic Supplies
- Post Regulator for Switching Power Supply

General Description

The APL1565A is a low dropout regulator which operates from 2.7V to 6V input voltage and delivers up to 1A current capability. In order to obtain lower dropout voltage and faster transient response which is critical for low voltage applications, the APL1565A has been optimized.

The device is available in fixed output voltages of 2.5V, 2.8V, and 3.3V. APL1565A Dropout voltage is guaranteed at a maximum of 210mV at 1A load.

Current limit is trimmed to ensure specified output current and controlled short-circuit current. On-chip thermal limiting provides protection against any combination of overload that would create excessive junction temperatures.

The APL1565A is available in the industry standard 8-pin SOP power package which can be used in applications where space is limited.

Pin Configuration

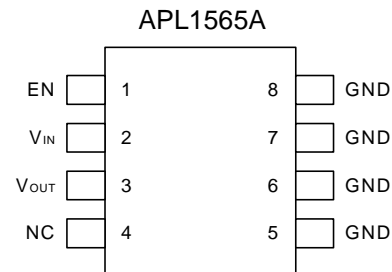

Front View for SOP-8

ANPEC reserves the right to make changes to improve reliability or manufacturability without notice, and advise customers to obtain the latest version of relevant information to verify before placing orders.

Ordering and Marking Information

<p>APL1565A □□□□ - □□□</p> <div style="margin-left: 40px;"> <p>└─ Assembly Material</p> <p>└─ Handling Code</p> <p>└─ Temperature Range</p> <p>└─ Package Code</p> <p>└─ Voltage Code</p> </div>	<p>Package Code K : SOP-8</p> <p>Temperature Range C : 0 to 70 °C</p> <p>Handling Code TR : Tape & Reel</p> <p>Voltage Code 25 : 2.5V 28 : 2.8V 33 : 3.3V</p> <p>Assembly Material L : Lead Free Device G : Halogen and Lead Free Device</p>
APL1565A-25K : APL1565A XXXXX25	XXXXX - Date Code
APL1565A-28K : APL1565A XXXXX28	XXXXX - Date Code
APL1565A-33K : APL1565A XXXXX33	XXXXX - Date Code

Note: ANPEC lead-free products contain molding compounds/die attach materials and 100% matte tin plate termination finish; which are fully compliant with RoHS. ANPEC lead-free products meet or exceed the lead-free requirements of IPC/JEDEC J-STD-020C for MSL classification at lead-free peak reflow temperature. ANPEC defines "Green" to mean lead-free (RoHS compliant) and halogen free (Br or Cl does not exceed 900ppm by weight in homogeneous material and total of Br and Cl does not exceed 1500ppm by weight).

Pin Description

PIN		I/O	Description
No.	Name		
1	EN	I	Enable control pin, low = off, high = normal.
2	VIN	I	Supply voltage input.
3	VOUT	O	Output pin of the regulator.
5, 6, 7, 8	GND		Ground pins of the circuitry, and all ground pins must be soldered to PCB with proper power dissipation.

Absolute Maximum Ratings (Note 1)

Symbol	Parameter	Rating	Unit
V _{IN} , V _{OUT}	Input Voltage or Out Voltage	6	V
EN	Enable Control Pin	6	V
R _{TH,JA}	Thermal Resistance – Junction to Ambient	210	°C/W
P _D	Power Dissipation	Internally Limited	W
T _J	Operating Junction Temperature		
	Control Section	0 to 125	°C
	Power Transistor	0 to 150	
T _{STG}	Storage Temperature Range	-65 to +150	°C
T _{SDR}	Maximum Lead Soldering Temperature, 10 seconds	260	°C

Note 1: Absolute Maximum Ratings are those values beyond which the life of a device may be impaired. Exposure to absolute maximum rating conditions for extended periods may affect device reliability.

Electrical Characteristics

Unless otherwise noted these specifications apply over full temperature, $V_{IN}=3.6V$, $C_{IN}=C_{OUT}=4.7\mu F$, $EN=V_{IN}$, $T_J=0$ to $125^\circ C$. Typical values refer to $T_J=25^\circ C$.

Symbol	Parameter	Test Conditions	APL1565A			Unit
			Min.	Typ.	Max.	
V_{IN}	Input Voltage		2.7		6	V
V_{OUT}	Output Voltage	$V_{OUT}+1.0V < V_{CC} < 6.0V$, $0mA < I_{OUT} < I_{MAX}$	$V_{OUT} - 2\%$	V_{OUT}	$V_{OUT} + 2\%$	V
I_{LIMIT}	Circuit Current Limit		1.0	1.2		A
REG_{LINE}	Line Regulation	$V_{OUT}+0.5V < V_{CC} < 6.0V$, $0mA < I_{OUT} < I_{MAX}$		4	10	mV
REG_{LOAD}	Load Regulation	$V_{IN} = V_{OUT}+1.0V$, $0mA < I_{OUT} < I_{MAX}$		1	6	mV
V_{DROP}	Dropout Voltage	$I_{OUT} = 1A$, $T_J = 0\sim 125^\circ C$		210	400	mV
PSRR	Ripple Rejection	$F \leq 1kHz$, $1V_{pp}$ at $V_{IN} = V_{OUT}+1.0V$	55	65		dB
I_Q	Quiescent Current	No load		50	100	μA
		$I_{OUT}=1A$		370	300	
	Shutdown Supply Current	$EN = low$ $I_{OUT}=0$, $V_{CC} = 6.0V$		0.01	1	μA
V_{IH}	Enable Pin	$V_{IN}=3.3V$	1.8		0.4	V
V_{IL}	Threshold					
OTS	Over Temperature			150		$^\circ C$
		Hysteresis		10		$^\circ C$
TC	Output Voltage Temperature Coefficient			50		ppm/ $^\circ C$

Typical Application Circuit

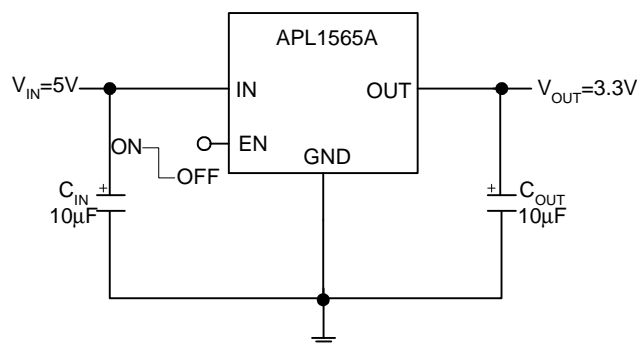

5V to 3.3V Regulation with Enable Function

Typical Characteristics

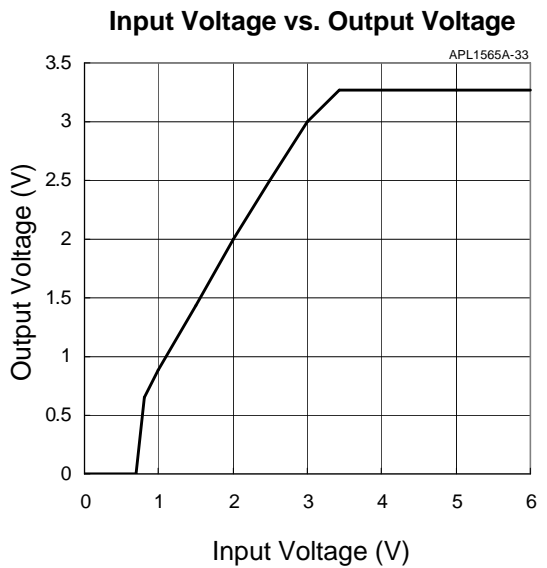
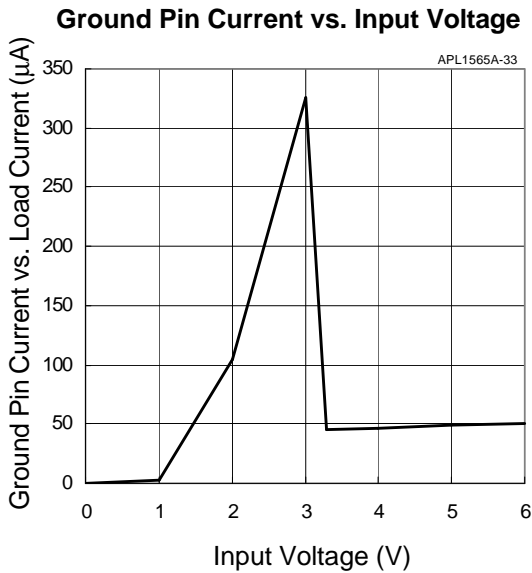
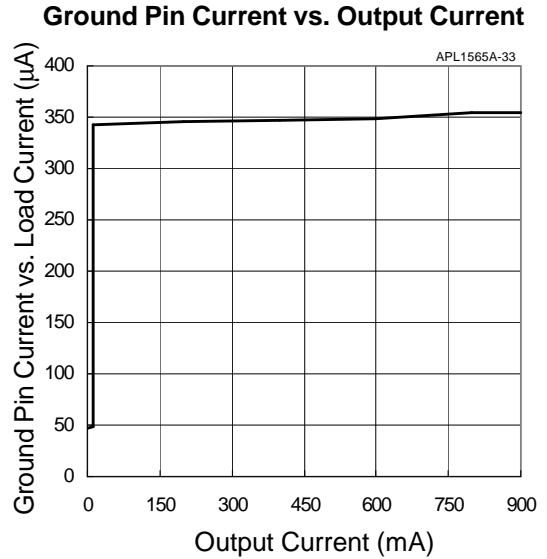
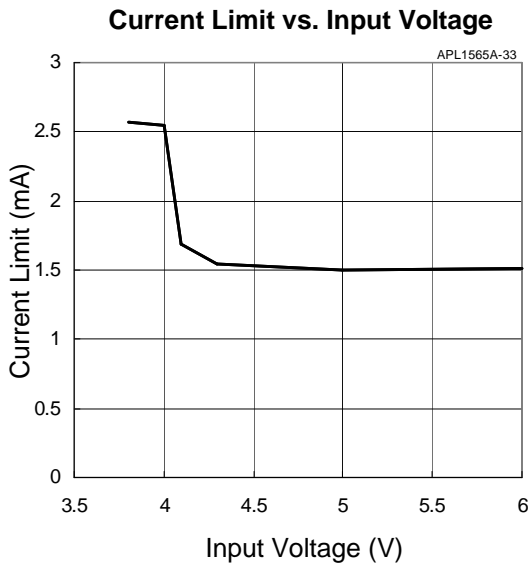

Typical Characteristics (Cont.)

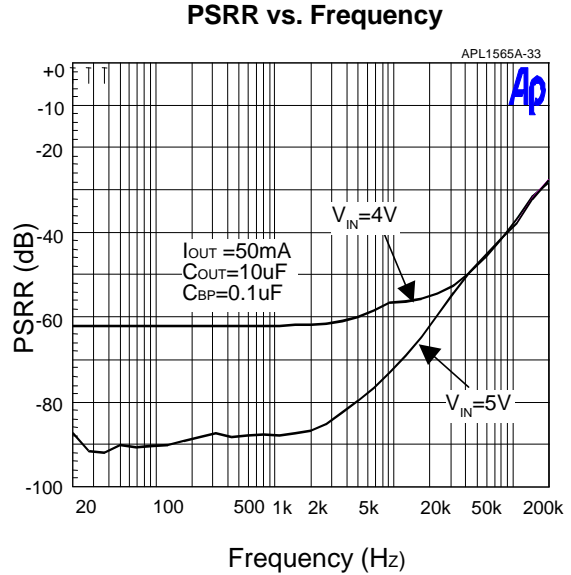
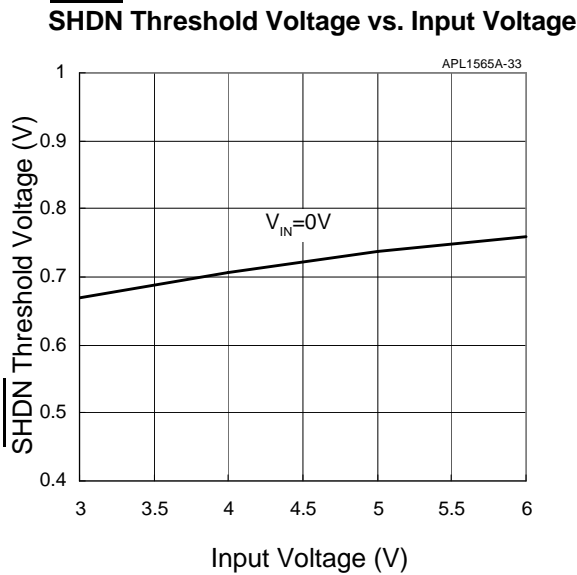
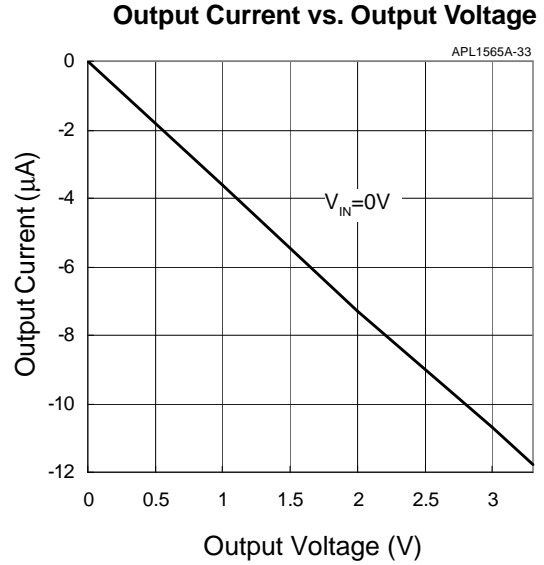
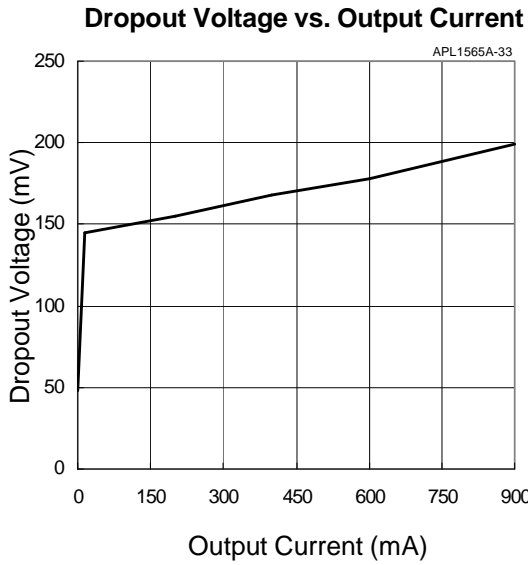

Typical Characteristics (Cont.)

Output Noise

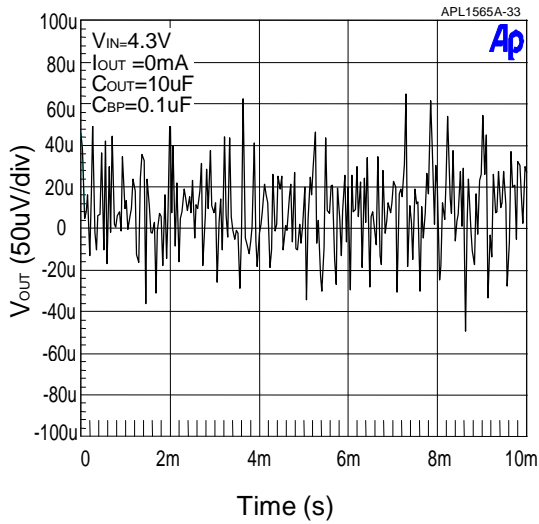

Output Noise vs. Bypass Capacitor

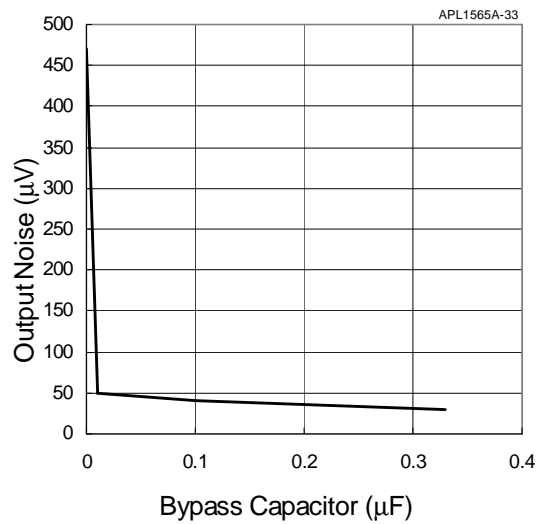

Load-Transient Response

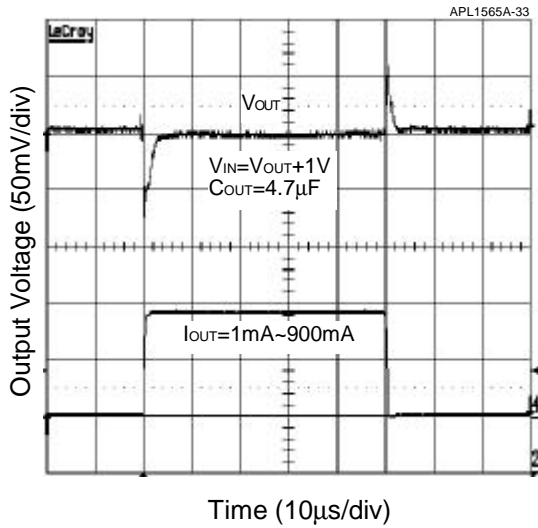

Line-Transient Response

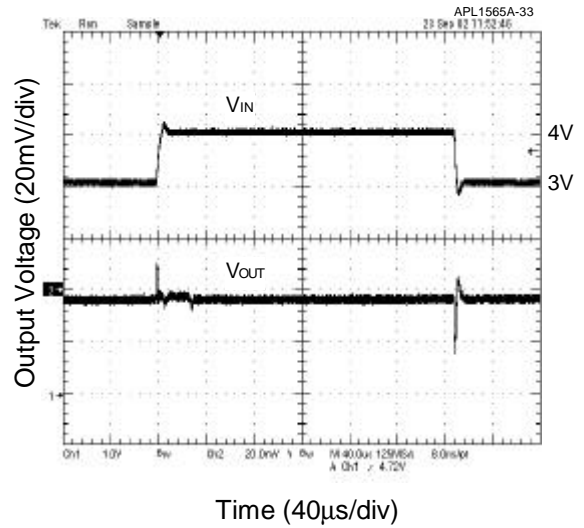

Typical Characteristics (Cont.)

Shutdown Exit Delay

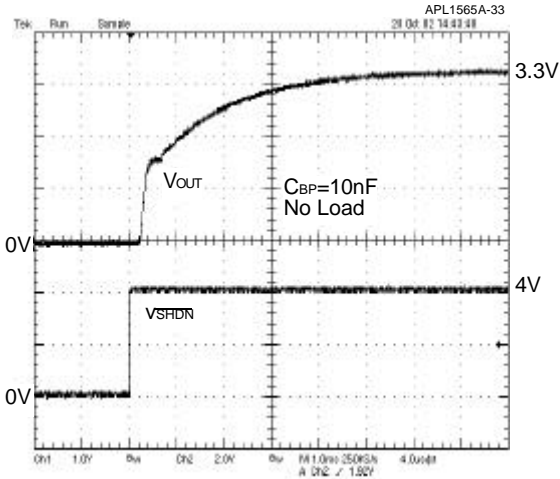

Shutdown Exit Delay

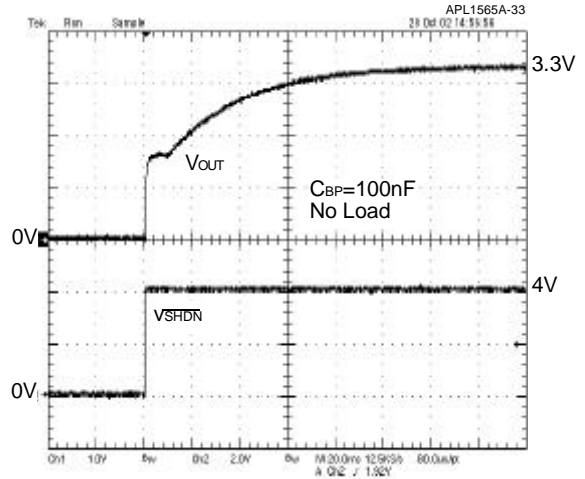

Entering Shutdown

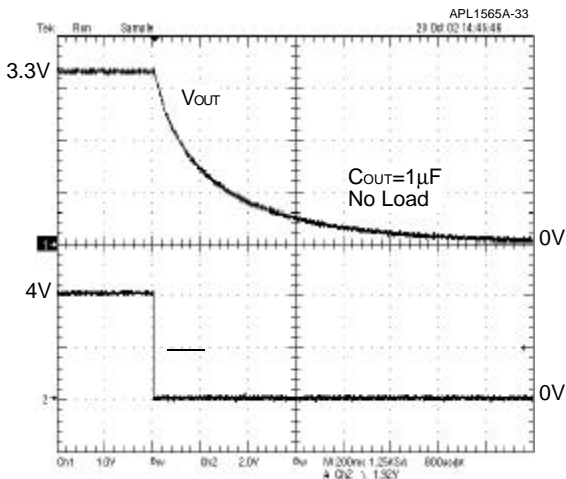

Region of Stable ESR vs. Load Current

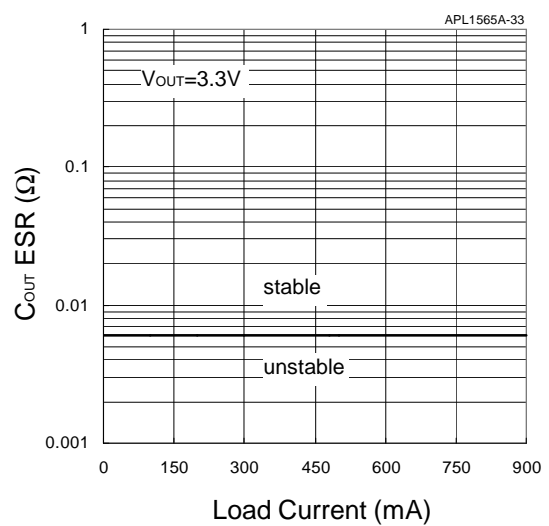

Typical Characteristics (Cont.)

Output Voltage vs. Junction Temperature

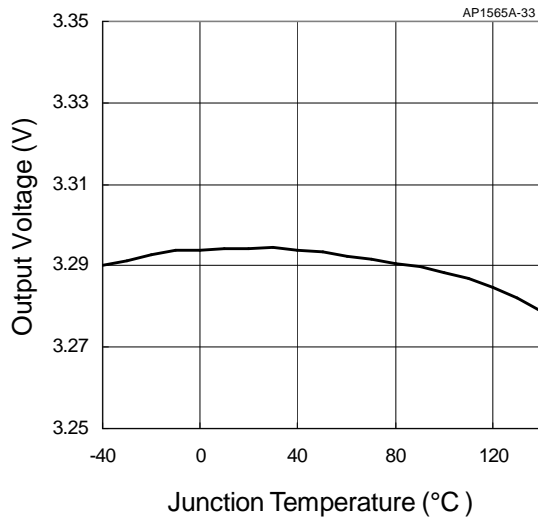

Application Information

Capacitor Selection and Regulator Stability

The APL1565A uses at least a 4.7 μ F capacitor on the input. This capacitor can use Aluminum, Tantalum or Ceramic capacitors. Input capacitor with large values and low ESR provides better PSRR and line-transient response. The output capacitor also can use Aluminum, Tantalum or Ceramic capacitors, and a minimum value of 10 μ F and ESR above 0.06W is recommended. A larger output capacitor can reduce noise and improve load-transient response, stability and PSRR.

Load-Transient Considerations

The APL1565A load-transient response graphs in typical characteristics show the transient response. A step change in the load current from 0mA to 1A at 1 μ s will cause a 100mV transient spike. Larger output capacitor and lower ESR can reduce transient spike.

Input-Output (Dropout) Voltage

The minimum input-output voltage difference (dropout) determines the lowest usable supply voltage. In battery-powered systems, this will determine the useful end-of-life battery voltage. Because the APL1565A uses a p-

channel MOSFET pass transistor, the dropout voltage is a function of drain-to-source on-resistance ($R_{DS(ON)}$) multiplied by the load current.

Reverse Current Protection

The APL1565A has an internal reverse protection, and it does not need an external schottky diode to connect the regulator input and output. If the output voltage is forced above the input voltage by more than 11mV, the IC will be shutdown and the ground pin current is below 0.1 μ A.

Current Limit

The APL1565A has a current limit protection. The output voltage will drop close to zero volt when load current reaches the limit, and then the load current will be limited at 150mA after output voltage is below 0.7V. When the load current back to the value where limiting started, the output voltage and current will return to normal value. When output is shorted to ground, the APL1565A will keep short circuit current at 150mA .

Application Information

Thermal Protection

Thermal protection limits total power dissipation in the device. When the junction temperature exceeds $T_{j,+150}$, the thermal sensor generates a logic signal to turn off the pass transistor and allows IC to cool. When the IC's junction temperature cools down by 10 , the thermal sensor will turn the pass transistor on again, resulting in a pulsed output during continuous thermal protection. Thermal protection is designed to protect it in the event of fault conditions. For continuous operation, it should not exceed the absolute maximum junction temperature of $T_{j,+150}$.

Operating Region and Power Dissipation

The thermal resistance of the case to circuit board, and the rate of air flow all control the APL1565A's maximum power dissipation. The power dissipation across the device is $P_D = I_{OUT}(V_{IN}-V_{OUT})$ and the maximum power dissipation is:

$$P_{D_{MAX}} = (T_J - T_A) / (R_{JC} + R_{CA})$$

where $T_J - T_A$ is the temperature difference between the junction and ambient air, R_{JC} is the thermal resistance of the package, and R_{CA} is the thermal resistance through the printed circuit board, copper traces, and other materials to the ambient air.

The GND pin of the APL1565A provides an electrical connection to ground and channeling heat away. If power dissipation is large, connecting the GND pin to ground by using a large pad or ground plane can improve the problem of over heat of IC.

Package Information

SOP-8

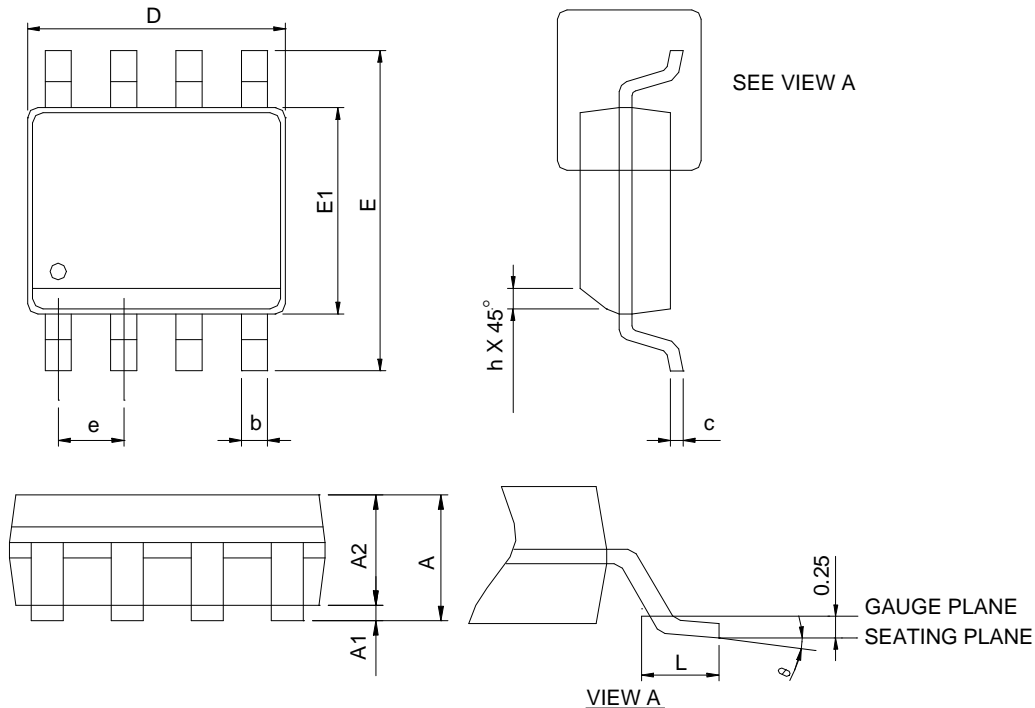

SYMBOL	SOP-8			
	MILLIMETERS		INCHES	
	MIN.	MAX.	MIN.	MAX.
A		1.75		0.069
A1	0.10	0.25	0.004	0.010
A2	1.25		0.049	
b	0.31	0.51	0.012	0.020
c	0.17	0.25	0.007	0.010
D	4.80	5.00	0.189	0.197
E	5.80	6.20	0.228	0.244
E1	3.80	4.00	0.150	0.157
e	1.27 BSC		0.050 BSC	
h	0.25	0.50	0.010	0.020
L	0.40	1.27	0.016	0.050
θ	0°	8°	0°	8°

- Note: 1. Follow JEDEC MS-012 AA.
 2. Dimension "D" does not include mold flash, protrusions or gate burrs. Mold flash, protrusion or gate burrs shall not exceed 6 mil per side.
 3. Dimension "E" does not include inter-lead flash or protrusions. Inter-lead flash and protrusions shall not exceed 10 mil per side.

Carrier Tape & Reel Dimensions

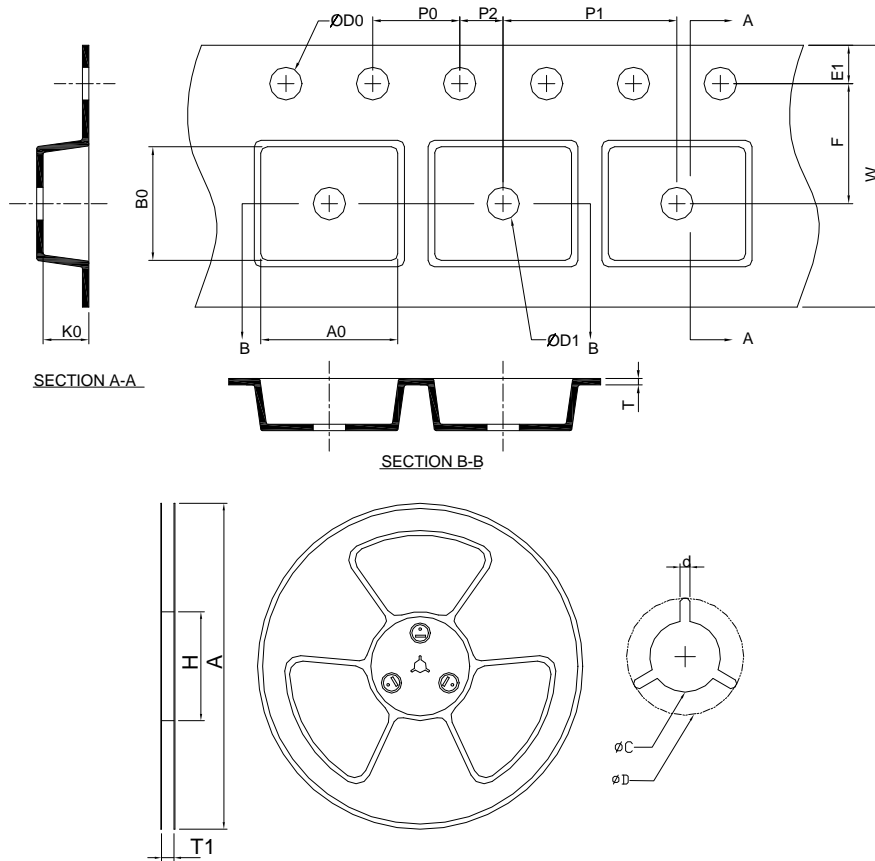

Application	A	H	T1	C	d	D	W	E1	F
SOP-8	330.0 ± 2.00	50 MIN.	12.4+2.00 -0.00	13.0+0.50 -0.20	1.5 MIN.	20.2 MIN.	12.0 ± 0.30	1.75 ± 0.10	5.5 ± 0.05
	P0	P1	P2	D0	D1	T	A0	B0	K0
	4.0 ± 0.10	8.0 ± 0.10	2.0 ± 0.05	1.5+0.10 -0.00	1.5 MIN.	0.6+0.00 -0.40	6.40 ± 0.20	5.20 ± 0.20	2.10 ± 0.20

(mm)

Devices Per Unit

Package Type	Unit	Quantity
SOP- 8	Tape & Reel	2500

Reflow Condition (IR/Convection or VPR Reflow)

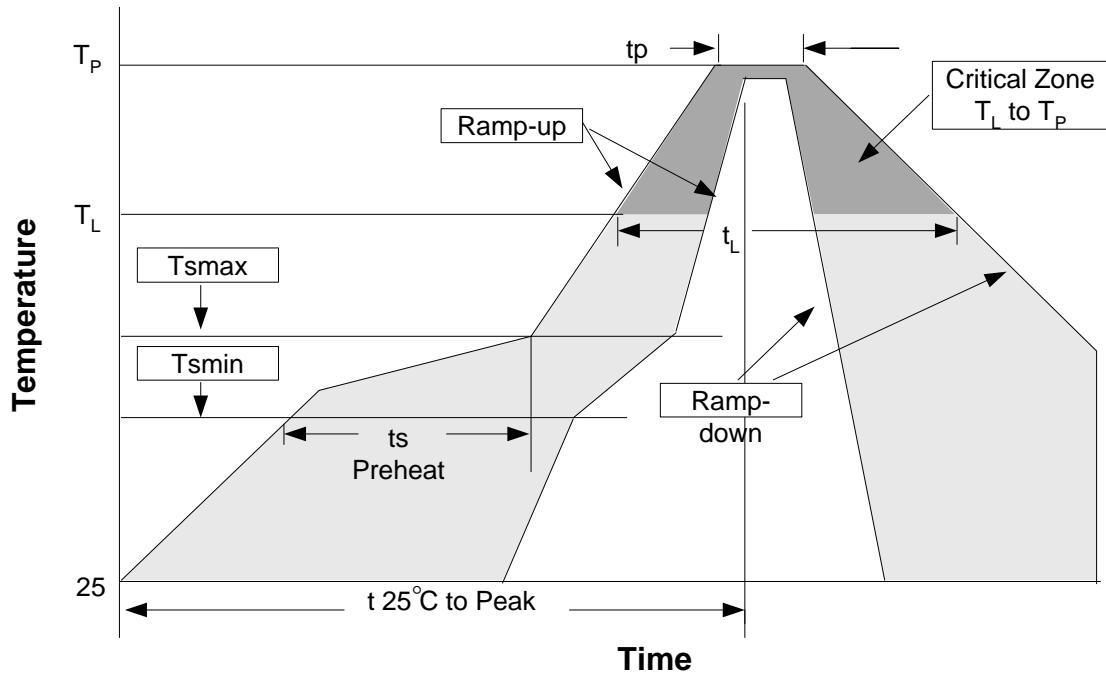

Reliability Test Program

Test item	Method	Description
SOLDERABILITY	MIL-STD-883D-2003	245°C, 5 sec
HOLT	MIL-STD-883D-1005.7	1000 Hrs Bias @ 125°C
PCT	JESD-22-B, A102	168 Hrs, 100%RH, 121°C
TST	MIL-STD-883D-1011.9	-65°C~150°C, 200 Cycles
ESD	MIL-STD-883D-3015.7	VHBM > 2KV, VMM > 200V
Latch-Up	JESD 78	10ms, $1_{tr} > 100\text{mA}$

Classification Reflow Profiles

Profile Feature	Sn-Pb Eutectic Assembly	Pb-Free Assembly
Average ramp-up rate (T_L to T_p)	3°C/second max.	3°C/second max.
Preheat		
- Temperature Min (T_{smin})	100°C	150°C
- Temperature Max (T_{smax})	150°C	200°C
- Time (min to max) (t_s)	60-120 seconds	60-180 seconds
Time maintained above:		
- Temperature (T_L)	183°C	217°C
- Time (t_L)	60-150 seconds	60-150 seconds
Peak/Classification Temperature (T_p)	See table 1	See table 2
Time within 5°C of actual Peak Temperature (t_p)	10-30 seconds	20-40 seconds
Ramp-down Rate	6°C/second max.	6°C/second max.
Time 25°C to Peak Temperature	6 minutes max.	8 minutes max.

Note: All temperatures refer to topside of the package. Measured on the body surface.

Classification Reflow Profiles (Cont.)

Table 1. SnPb Eutectic Process – Package Peak Reflow Temperatures

Package Thickness	Volume mm ³ <350	Volume mm ³ ≥350
<2.5 mm	240 +0/-5°C	225 +0/-5°C
≥2.5 mm	225 +0/-5°C	225 +0/-5°C

Table 2. Pb-free Process – Package Classification Reflow Temperatures

Package Thickness	Volume mm ³ <350	Volume mm ³ 350-2000	Volume mm ³ >2000
<1.6 mm	260 +0°C*	260 +0°C*	260 +0°C*
1.6 mm – 2.5 mm	260 +0°C*	250 +0°C*	245 +0°C*
≥2.5 mm	250 +0°C*	245 +0°C*	245 +0°C*

*Tolerance: The device manufacturer/supplier **shall** assure process compatibility up to and including the stated classification temperature (this means Peak reflow temperature +0°C. For example 260°C+0°C) at the rated MSL level.

Customer Service

Anpec Electronics Corp.

Head Office :

No.6, Dusing 1st Road, SBIP,
Hsin-Chu, Taiwan
Tel : 886-3-5642000
Fax : 886-3-5642050

Taipei Branch :

2F, No. 11, Lane 218, Sec 2 Jhongsing Rd.,
Sindian City, Taipei County 23146, Taiwan
Tel : 886-2-2910-3838
Fax : 886-2-2917-3838