

REV.	ECN Number	Description	Drawn
1	CS21100033	初版发行	2021/10/13

- 备注:
1. 塑胶材料: LCP-GA130, 黑色, 防火等级: UL 94v-0
 2. 端子材料: 铜合金
 3. 额定电压: 50V AC/DC for 1 minute
 4. 接触阻抗: 50mΩ max. initial (不包括导体阻抗)
 5. 耐电压: 500V AC for 1 minute
 6. 绝缘阻抗: 100MΩ min.
 7. 额定电流: 0.5A
 8. 寿命: 30次 min
 9. 插入力: 150gf max. /pin, 拔出力: 8.5gf min. /pin
 10. 保持力: 250gf 最小/pin
 11. 有害物质需符合Rohs2.0标准.
 12. 尺寸符合ANSI Y14.5M-1994.

料号说明:
 BB41-XXFT-1B-XHR
 F: 塑胶高度11.35mm
 公母合高12.70mm-13.70mm
 Pin数

X方向浮动量: ±0.5
 Y方向浮动量: ±0.5
 Z方向浮动量: ±0.5



TOLERANCE UNLESS OTHERWISE SPECIFIED			
X.X	±0.35	X.*	±5°
X.XX	±0.20	X.X*	±3°
X.XXX		X.XX*	±2°

SCALE	1:1	ORIGINAL DRAWN:	Qin Su	DATE	2021/10/13
UNIT	mm	CHECK:	Guangyu Guo	DATE	2021/10/13
SIZE	A4	APPROVE:	Ady Zhou	DATE	2021/10/13

DWG. NO.	600-0000-0519
PARTS NO. (INTENDED USE)	BB41-XXFT-1B-XHR

TITLE	0.80mm Pitch 浮动BTB 客户图
-------	------------------------

REV.	1
SHEET	1/2

40PIN: BB41-40FT-1B-XHR

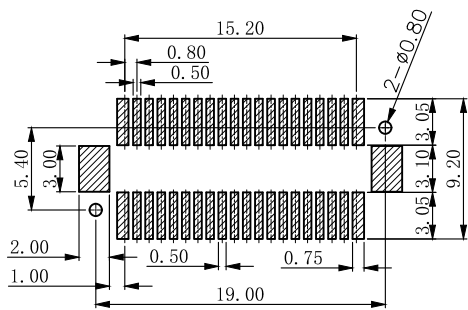
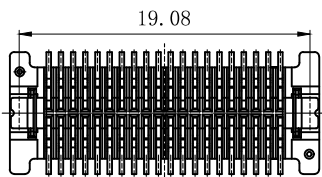
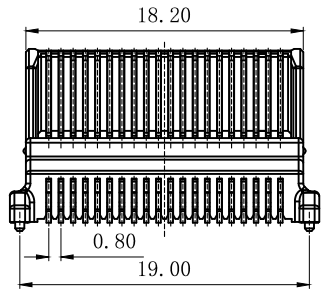
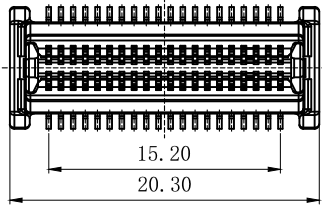

RECOMMENDED PCB LAYOUT
TOLERANCE: ±0.05mm

60PIN: BB41-60FT-1B-XHR

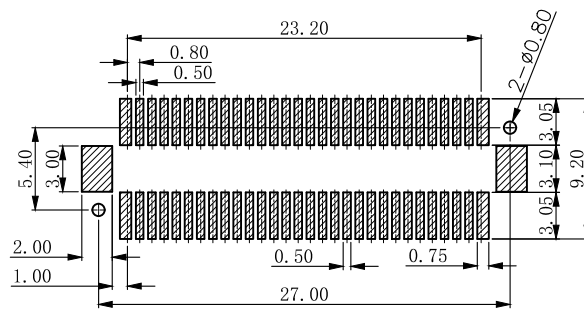
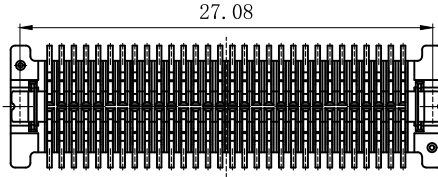
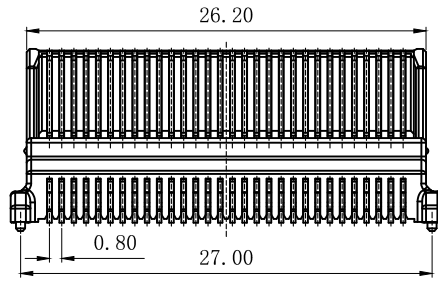
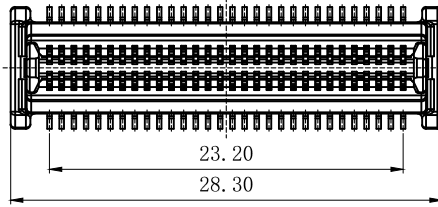

RECOMMENDED PCB LAYOUT
TOLERANCE: ±0.05mm

80PIN: BB41-80FT-1B-XHR

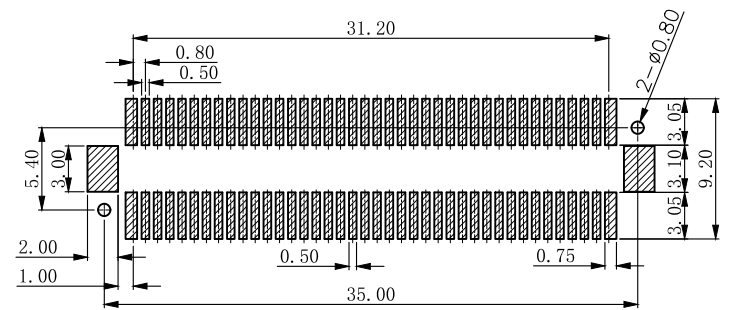
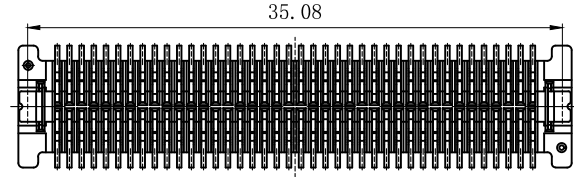
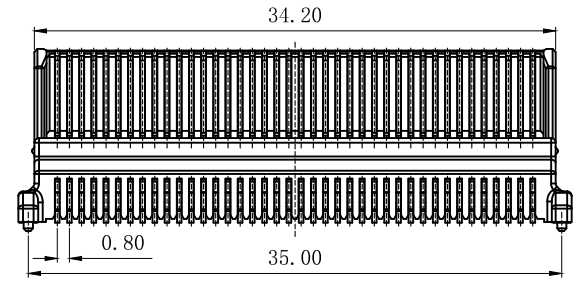
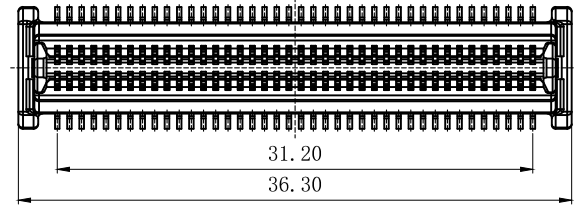

RECOMMENDED PCB LAYOUT
TOLERANCE: ±0.05mm



ShenZhen ShenTai weiXiang Electronics Co.,

TOLERANCE UNLESS OTHERWISE SPECIFIED

X.X	±0.35	X.*	±5°
X.XX	±0.20	X.X*	±3°
X.XXX		X.XX*	±2°

SCALE	1:1
UNIT	mm
SIZE	A4



ORIGINAL DRAWN:	Qin Su	DATE	2021/10/13
CHECK:	Guangyu Guo	DATE	2021/10/13
APPROVE:	Ady Zhou	DATE	2021/10/13

DWG. NO.	600-0000-0519
PARTS NO. (INTENDED USE)	BB41-XXFT-1B-XHR

TITLE	0.80mm Pitch 浮动BTB 客户图
-------	---------------------------

REV.	1
SHEET	2/2