

PLEASE CHECK WWW.MOLEX.COM FOR LATEST PART INFORMATION

Part Number: [0791091267](#)
Status: **Active**
Description: 2.00mm (.079") Pitch Milli-Grid™ Receptacle, Surface Mount, Vertical, Top/Bottom Entry, with Press-fit Plastic Pegs, without Cap, Tube, 0.76µm (30µ") Gold (Au) Selective, 36 Circuits, Leadfree

Documents:

[3D Model](#) [Product Specification PS-79107 \(PDF\)](#)
[Drawing \(PDF\)](#) [RoHS Certificate of Compliance \(PDF\)](#)

Agency Certification

CSA LR19980
 UL E29179

General

Product Family PCB Receptacles
 Series [79109](#)
 Application Board-to-Board
 Product Name Milli-Grid™

Physical

Circuits (Loaded) 36
 Color - Resin Black
 Durability (mating cycles max) 50
 Flammability 94V-0
 Glow-Wire Compliant No
 Lock to Mating Part None
 Material - Metal Phosphor Bronze
 Material - Plating Mating Gold
 Material - Plating Termination Tin
 Material - Resin High Temperature Thermoplastic
 Number of Rows 2
 Orientation Vertical
 PCB Locator Yes
 PCB Retention Yes
 Packaging Type Tube
 Pitch - Mating Interface (in) 0.079 In
 Pitch - Mating Interface (mm) 2.00 mm
 Plating min: Mating (µin) 30
 Plating min: Mating (µm) 0.75
 Plating min: Termination (µin) 75
 Plating min: Termination (µm) 1.875
 Polarized to Mating Part No
 Polarized to PCB No
 Surface Mount Compatible (SMC) N/A
 Temperature Range - Operating -55°C to +105°C
 Termination Interface: Style Surface Mount

Electrical

Current - Maximum per Contact 1A
 Voltage - Maximum 125V

Solder Process Data

Lead-free Process Capability Reflow Capable (SMT only)
 Process Temperature max. C 260

Material Info

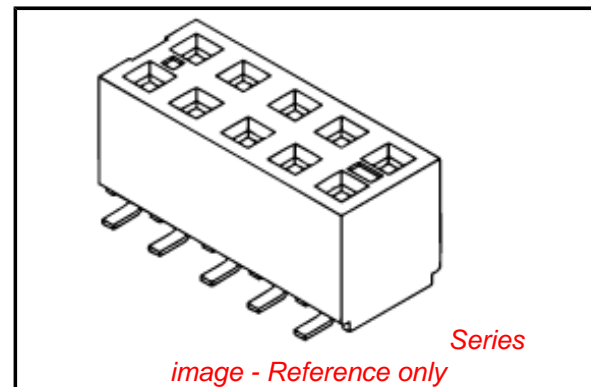

EU RoHS

ELV and RoHS Compliant
REACH SVHC
 Not Reviewed
Halogen-Free Status
 Not Reviewed

China RoHS



Need more information on product environmental compliance?

Email productcompliance@molex.com
 For a multiple part number RoHS Certificate of Compliance, [click here](#)

Please visit the [Contact Us](#) section for any non-product compliance questions.

Search Parts in this Series

[79109Series](#)

Mates With

[87833](#) , [87832](#) , [87831](#) , [87758](#) , [87759](#) , [87760](#)

Reference - Drawing Numbers

Product Specification
Sales Drawing

PS-79107
SDA-79109-****

This document was generated on 03/18/2010

PLEASE CHECK WWW.MOLEX.COM FOR LATEST PART INFORMATION



NOTES:

1. HOUSING MATERIAL:
LCP, GLASS FILLED, UL 94V-0
COLOUR BLACK.
2. TERMINAL MATERIAL:
PHOSPHOR BRONZE
3. SEE APPROPRIATE SHEET FOR CIRCUIT SIZE,
PART NUMBERS AND OVERALL DIMENSIONS.
4. FOR ILLUSTRATION, 6 CKT ASSY SHOWN.
5. REFER TO PRODUCT SPEC PS-79107.
6. TUBE PACKAGING PER PK-70873-0217 OR
TAPE PACKAGING PER PK-70873-0259
7. SEE SHT 3 FOR PEG OPTION ASSEMBLIES.
8. CKT LOCATIONS ARE NUMBERED FROM LEFT TO
RIGHT WHEN VIEWING ASSY FROM TOP WITH
THE GATE RECESS ON THE RIGHT AS SHOWN.
9. SEE SHT 5 & 6 FOR VOIDED CIRCUIT PART NUMBERS.
10. MEASUREMENT IS TAKEN BETWEEN THE TANGENT OF
THE TOE TO TIP OF THE TERMINAL.

PLATING OPTION:

4. 30u* (0.75um) MIN. GOLD PLATE IN SELECTED AREA AND
75u* (1.88um) MIN. TIN PLATE IN SELECTED AREA OVER
50u* (1.25um) MIN. NICKEL OVERALL.
5. 15u* (0.38um) MIN. GOLD PLATE IN SELECTED AREA AND
75u* (1.88um) MIN. TIN PLATE IN SELECTED AREA OVER
50u* (1.25um) MIN. NICKEL OVERALL.
6. 5u* (0.13um) MIN. GOLD PLATE IN SELECTED AREA AND
75u* (1.88um) MIN. TIN PLATE IN SELECTED AREA OVER
50u* (1.25um) MIN. NICKEL OVERALL.



SECTION A-A



SECTION B-B



DETAIL A BENDING ANGLE OF TAIL



REVISED EC NO: S2010-0566 DRWN:SKANG 2010/01/05 CHYKD:ATSEE 2010/02/03 APPR:MLONG 2010/02/19 M6	QUALITY SYMBOLS $F_A=0$ $F_C=0$ $F_P=0$	GENERAL TOLERANCES (UNLESS SPECIFIED)		DIMENSION STYLE IN/MM		SCALE NTS	DESIGN UNITS INCH	THIRD ANGLE PROJECTION	
		4 PLACES ± --- ± --- 3 PLACES ± --- ± 0.10 2 PLACES ± 0.25 ± 0.15 1 PLACE ± 0.38 ± ---	mm INCH	DRAWN BY AAB	DATE 1989/05/15	TITLE 2MM DUAL ROW VERTICAL RECEPTACLE, SMT			
		ANGULAR ± 3 °		CHECKED BY MJM	DATE 1989/05/15	MOLEX INCORPORATED			
		DRAFT WHERE APPLICABLE MUST REMAIN WITHIN DIMENSIONS		APPROVED BY MLONG	DATE 2010/02/18	MATERIAL NO. SEE TABLE	DOCUMENT NO. SDA-79109-****	SHEET NO. 1 OF 10	

WITHOUT PEG OPTION

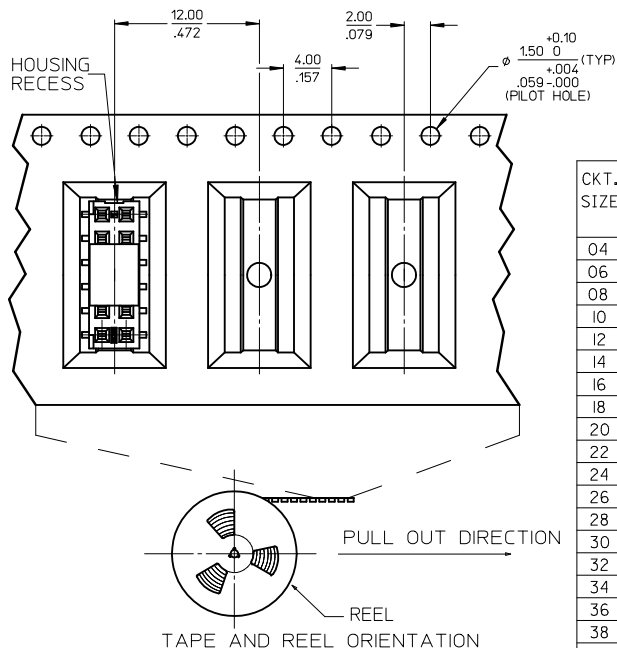

CKT. SIZE	DIM. "A"		DIM. "B"		DIM. "D"		PLATING OPTION 5		PLATING OPTION 4		PLATING OPTION 6	
	INCH	MM	INCH	MM	INCH	MM	ITEM NO. TUBE PACKED (WITHOUT CAP)	ITEM NO. TAPE PACKED (WITH CAP A)	ITEM NO. TUBE PACKED (WITHOUT CAP)	ITEM NO. TAPE PACKED (WITH CAP A)	ITEM NO. TUBE PACKED (WITHOUT CAP)	ITEM NO. TAPE PACKED (WITH CAP A)
04	.079	(2.00)	.165	(4.19)	.183	(4.65)	79109-1001	79109-8401	79109-1051	79109-8451	X	79109-1101
06	.157	(4.00)	.244	(6.19)	.183	(4.65)	79109-1002	79109-8402	79109-1052	79109-8452	X	79109-1102
08	.236	(6.00)	.322	(8.19)	.183	(4.65)	79109-1003	79109-8403	79109-1053	79109-8453	X	79109-1103
10	.315	(8.00)	.401	(10.19)	.183	(4.65)	79109-1004	79109-8404	79109-1054	79109-8454	X	79109-1104
12	.394	(10.00)	.480	(12.19)	.183	(4.65)	79109-1005	79109-8405	79109-1055	79109-8455	X	79109-1105
14	.472	(12.00)	.559	(14.19)	.183	(4.65)	79109-1006	79109-8406	79109-1056	79109-8456	X	79109-1106
16	.551	(14.00)	.637	(16.19)	.183	(4.65)	79109-1007	79109-8407	79109-1057	79109-8457	X	79109-1107
18	.630	(16.00)	.716	(18.19)	.183	(4.65)	79109-1008	79109-8408	79109-1058	79109-8458	X	79109-1108
20	.709	(18.00)	.795	(20.19)	.183	(4.65)	79109-1009	79109-8409	79109-1059	79109-8459	X	79109-1109
22	.787	(20.00)	.874	(22.19)	.183	(4.65)	79109-1010	79109-8410	79109-1060	79109-8460	X	79109-1110
24	.866	(22.00)	.952	(24.19)	.183	(4.65)	79109-1011	79109-8411	79109-1061	79109-8461	X	79109-1111
26	.945	(24.00)	1.031	(26.19)	.183	(4.65)	79109-1012	79109-8412	79109-1062	79109-8462	X	79109-1112
28	1.024	(26.00)	1.110	(28.19)	.183	(4.65)	79109-1013	79109-8413	79109-1063	79109-8463	X	79109-1113
30	1.102	(28.00)	1.188	(30.19)	.183	(4.65)	79109-1014	79109-8414	79109-1064	79109-8464	X	79109-1114
32	1.181	(30.00)	1.267	(32.19)	.183	(4.65)	79109-1015	79109-8415	79109-1065	79109-8465	X	79109-1115
34	1.260	(32.00)	1.346	(34.19)	.183	(4.65)	79109-1016	79109-8416	79109-1066	79109-8466	X	79109-1116
36	1.338	(34.00)	1.425	(36.19)	.183	(4.65)	79109-1017	79109-8417	79109-1067	79109-8467	X	79109-1117
38	1.417	(36.00)	1.504	(38.19)	.183	(4.65)	79109-1018	79109-8418	79109-1068	79109-8468	X	79109-1118
40	1.496	(38.00)	1.582	(40.19)	.183	(4.65)	79109-1019	79109-8419	79109-1069	79109-8469	X	79109-1119
42	1.575	(40.00)	1.661	(42.19)	.183	(4.65)	79109-1020	79109-8420	79109-1070	79109-8470	X	79109-1120
44	1.654	(42.00)	1.740	(44.19)	.183	(4.65)	79109-1021	79109-8421	79109-1071	79109-8471	X	79109-1121
46	1.732	(44.00)	1.818	(46.19)	.183	(4.65)	79109-1022	79109-8422	79109-1072	79109-8472	X	79109-1122
48	1.811	(46.00)	1.897	(48.19)	.183	(4.65)	79109-1023	79109-8423	79109-1073	79109-8473	X	79109-1123
50	1.890	(48.00)	1.976	(50.19)	.183	(4.65)	79109-1024	79109-8424	79109-1074	79109-8474	X	79109-1124

NOTES:

1. LEADER AND TRAILER TAPE

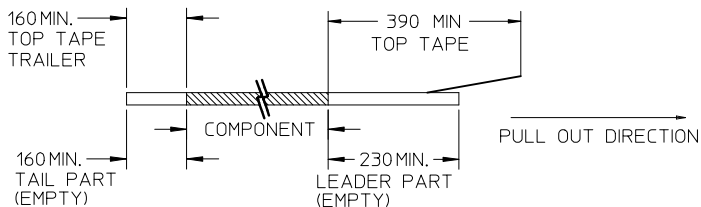

2. PEELING OFF FORCE OF THE TOP TAPE: 20-80gf.
(PEELING DIRECTION AS SHOWN IN FOLLOWING FIGURE)

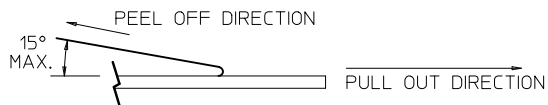

3. PACKAGING STANDARD IS AS PER EIA-481.

4. TAPE & REEL QUANTITY = 500 PCS/REEL

X INDICATES TOOLING NOT AVAILABLE

SPECIAL PACKAGING (TAPE PACKED WITHOUT CAP)

CKT. SIZE	DIM. "A"		DIM. "B"		DIM. "D"		ITEM NO.	PLATING OPTION SEE SHEET 1
	INCH	MM	INCH	MM	INCH	MM		
06	.157	(4.00)	.244	(6.19)	.183	(4.65)	79109-9004	5
20	.709	(18.00)	.795	(20.19)	.183	(4.65)	79109-9005	5
50	1.890	(48.00)	1.976	(50.19)	.183	(4.65)	79109-9006	5
34	1.260	(32.00)	1.346	(34.19)	.183	(4.65)	79109-9007	5

REVISED EC NO: S2010-0566 DRWN:SKANG CHKD:ATSEE APPR:MLONG 2010/01/05 2010/02/03 2010/02/19	QUALITY SYMBOLS $F_A=0$ $F_C=0$ $F_P=0$	GENERAL TOLERANCES (UNLESS SPECIFIED)		DIMENSION STYLE IN/MM		SCALE NTS	DESIGN UNITS INCH		THIRD ANGLE PROJECTION		
		4 PLACES ± --- ± --- 3 PLACES ± --- ± --- 2 PLACES ± 0.25 ± 0.15 1 PLACE ± 0.38 ± ---		DRAWN BY: AAB DATE: 1989/05/15		TITLE: 2MM DUAL ROW VERTICAL RECEPTACLE, SMT		APPROVED BY: MLONG DATE: 2010/02/18		MOLEX INCORPORATED	
		ANGULAR ± 3°		DRAFT WHERE APPLICABLE MUST REMAIN WITHIN DIMENSIONS		MATERIAL NO. SEE TABLE		DOCUMENT NO. SDA-79109-****		SHEET NO. 2 OF 10	
		SIZE A3		THIS DRAWING CONTAINS INFORMATION THAT IS PROPRIETARY TO MOLEX INCORPORATED AND SHOULD NOT BE USED WITHOUT WRITTEN PERMISSION							

ASSEMBLIES WITHOUT PEGS
VOIDED CIRCUIT OPTION

CKT. SIZE	ASSEMBLY (WITHOUT CAP IN TUBE)	VOID LOCATION(S) SEE SHEET 1 FOR CONVENTION		PLATING OPTION	DIM. "A"		DIM. "B"		DIM. "D"	
	PART NUMBER	ROW	CKT. NO.(s)		INCH	MM	INCH	MM	INCH	MM
22	79109-5011	A	2	4	.787	(20.00)	.874	(22.19)	.183	(4.65)
6	79109-5012	A	2	5	.157	(4.00)	.244	(6.19)	.183	(4.65)

CKT SIZE	ASSEMBLY (WITH CAP A IN T&R)	VOID LOCATION(S) SEE SHEET 1 FOR CONVENTION		PLATING OPTION	DIM A		DIM B		DIM D	
	PART NUMBER	ROW	CKT NO.		INCH	MM	INCH	MM	INCH	MM
50	79109-8924	A	13, 23	5	1.890	(48.00)	1.976	(50.19)	.183	(4.65)
		B	23							

NOTES:

1. TERMINALS WILL BE PRESENT IN VOIDED LOCATIONS. HOWEVER, PIN WINDOWS WILL BE CLOSED.
2. VOIDS CAN ONLY BE PRESENT IN ONE ROW OF A CONNECTOR.

REVISED EC NO: S2010-0566 DRWN:SKANG 2010/01/05 CHKD:ATSEE 2010/02/03 APPR:MLONG 2010/02/19	QUALITY SYMBOLS	GENERAL TOLERANCES (UNLESS SPECIFIED)	DIMENSION STYLE IN/MM	SCALE NTS	DESIGN UNITS INCH	THIRD ANGLE PROJECTION
	$F_A=0$	4 PLACES ± --- ± ---	mm INCH	DRAWN BY AAB	DATE 1989/05/15	TITLE 2MM DUAL ROW VERTICAL RECEPTACLE, SMT
	$F_G=0$	3 PLACES ± --- ± .010		CHECKED BY MJM	DATE 1989/05/15	 MOLEX INCORPORATED
	$F_P=0$	2 PLACES ± 0.25 ± .015		APPROVED BY MLONG	DATE 2010/02/18	
	1 PLACE ± 0.38 ± ---	ANGULAR ± 3 °	MATERIAL NO. SEE TABLE	DOCUMENT NO. SDA-79109-****	SHEET NO. 3 OF 10	
		DRAFT WHERE APPLICABLE MUST REMAIN WITHIN DIMENSIONS	SIZE A3	THIS DRAWING CONTAINS INFORMATION THAT IS PROPRIETARY TO MOLEX INCORPORATED AND SHOULD NOT BE USED WITHOUT WRITTEN PERMISSION		

PEG OPTION



CONNECTOR WITH CAP

PLATING OPTION:

- (4) 30uIn (0.75um) MIN. GOLD PLATE IN SELECTED AREA AND 75uIn (1.88um) MIN. TIN IN SELECTED AREA OVER 50uIn (1.25um) MIN. NICKEL OVER-ALL.
- (5) 15uIn (0.38um) MIN. GOLD PLATE IN SELECTED AREA AND 75uIn (1.88um) MIN. TIN IN SELECTED AREA OVER 50uIn (1.25um) MIN. NICKEL OVER-ALL.
- (6) 5uIn (0.13um) MIN. GOLD PLATE IN SELECTED AREA AND 75uIn (1.88um) MIN. TIN IN SELECTED AREA OVER 50uIn (1.25um) MIN. NICKEL OVER-ALL.

NOTES:

- 1 - HOUSING MATERIAL: GLASS FILLED HIGH TEMP. THERMOPLASTIC. COLOR: BLACK.
- 2 - TERMINAL MATERIAL: PHOSPHOR BRONZE
- 3 - SEE APPROPRIATE SHEET FOR CIRCUIT SIZE, PART NUMBERS AND OVER-ALL DIMENSIONS.
- 4 - FOR ILLUSTRATION, 6&12 CIRCUIT ASSEMBLY SHOWN.
- 5 - REFER TO PRODUCT SPECIFICATION PS-79107.
- 6 - TUBE PACKAGING PER PK-70873-0217 OR TAPE PACKAGING PER PK-70873-0259.
- 7 - SEE PSX-79107 FOR SUGGESTED BOTTOM ENTRY PIN LENGTHS.
- 8 - .035 DIA. FOR PRESS FIT ONLY. USE .039±.002 FOR ALIGNMENT PURPOSES ON PICK AND PLACE.
- 9 - MEASUREMENT IS TAKEN BETWEEN THE TANGENT OF THE TOE TO TIP OF THE TERMINAL.



SECTION C-C

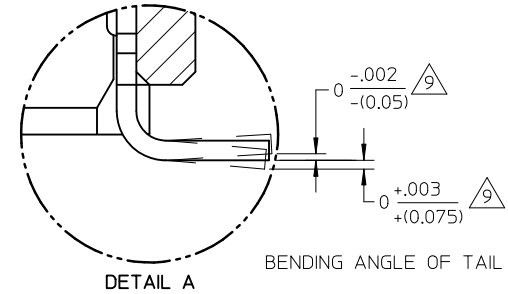
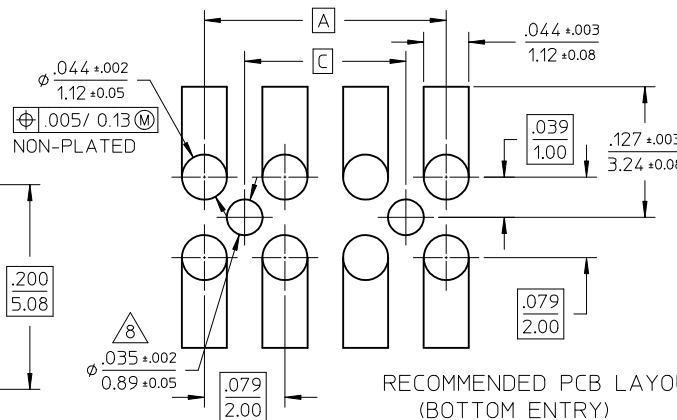
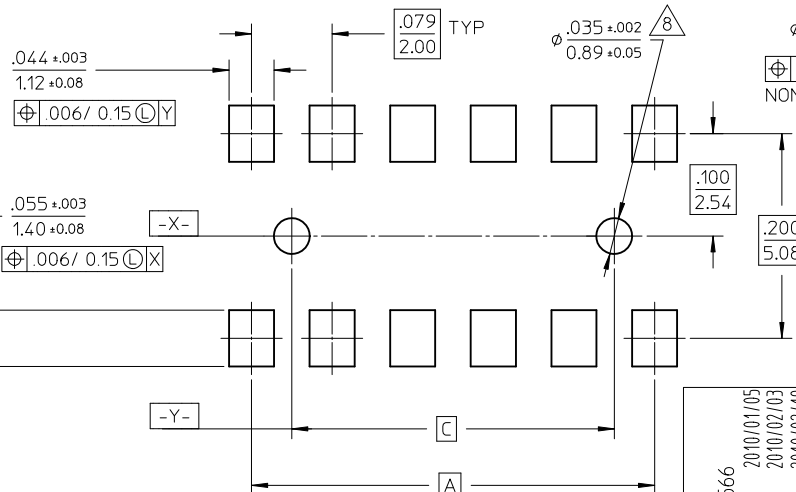
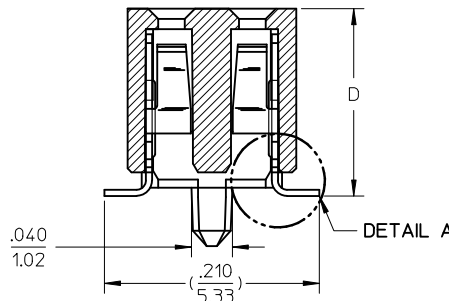

DETAIL A BENDING ANGLE OF TAIL

RECOMMENDED PCB LAYOUT

RECOMMENDED PCB LAYOUT (BOTTOM ENTRY)

REVISED EC NO: S2010-0566 DRWN:SKANG CHKD:ATSEE APPR:MLONG 2010/01/05 2010/02/03 2010/02/19	QUALITY SYMBOLS $F_A=0$ $F_C=0$ $F_P=0$	GENERAL TOLERANCES (UNLESS SPECIFIED) mm INCH 4 PLACES ± --- ± --- 3 PLACES ± --- ± .010 2 PLACES ± 0.25 ± .015 1 PLACE ± 0.38 ± --- ANGULAR ± 3 °	DIMENSION STYLE IN/MM DRAWN BY DATE AAB 1989/05/15 CHECKED BY DATE MJM 1989/05/15 APPROVED BY DATE MLONG 2010/02/18	SCALE NTS DESIGN UNITS INCH THIRD ANGLE PROJECTION	TITLE 2MM DUAL ROW VERTICAL RECEPTACLE, SMT MOLEX INCORPORATED DOCUMENT NO. SDA-79109-**** SHEET NO. 4 OF 10	
	DRAFT WHERE APPLICABLE MUST REMAIN WITHIN DIMENSIONS	MATERIAL NO. SEE TABLE	SIZE A3 THIS DRAWING CONTAINS INFORMATION THAT IS PROPRIETARY TO MOLEX INCORPORATED AND SHOULD NOT BE USED WITHOUT WRITTEN PERMISSION			
	M6	REV DESCRIPTION				

PEG OPTION

CKT. SIZE	DIM. "A"		DIM. "B"		DIM. "C"		DIM. "D"		PLATING OPTION 5		PLATING OPTION 4		PLATING OPTION 6		
	INCH	MM	INCH	MM	INCH	MM	INCH	MM	ITEM NO. TUBE PACKED (WITHOUT CAP)	ITEM NO. TAPE PACKED (WITH CAP A)	ITEM NO. TUBE PACKED (WITHOUT CAP)	ITEM NO. TAPE PACKED (WITH CAP A)	ITEM NO. TUBE PACKED (WITHOUT CAP)	ITEM NO. TAPE PACKED (WITH CAP A)	
04	.079	(2.00)	.165	(4.19)	-	-	.183	(4.65)	79109-1201	79109-8601	79109-1251	79109-8651	X	79109-1301	-
06	.157	(4.00)	.244	(6.19)	.079	(2.00)	.183	(4.65)	79109-1202	79109-8602	79109-1252	79109-8652	X	79109-1302	-
08	.236	(6.00)	.322	(8.19)	.157	(4.00)	.183	(4.65)	79109-1203	79109-8603	79109-1253	79109-8653	X	79109-1303	-
10	.315	(8.00)	.401	(10.19)	.236	(6.00)	.183	(4.65)	79109-1204	79109-8604	79109-1254	79109-8654	X	79109-1304	-
12	.394	(10.00)	.480	(12.19)	.315	(8.00)	.183	(4.65)	79109-1205	79109-8605	79109-1255	79109-8655	X	79109-1305	-
14	.472	(12.00)	.559	(14.19)	.394	(10.00)	.183	(4.65)	79109-1206	79109-8606	79109-1256	79109-8656	X	79109-1306	-
16	.551	(14.00)	.637	(16.19)	.472	(12.00)	.183	(4.65)	79109-1207	79109-8607	79109-1257	79109-8657	X	79109-1307	-
18	.630	(16.00)	.716	(18.19)	.551	(14.00)	.183	(4.65)	79109-1208	79109-8608	79109-1258	79109-8658	X	79109-1308	-
20	.709	(18.00)	.795	(20.19)	.630	(16.00)	.183	(4.65)	79109-1209	79109-8609	79109-1259	79109-8659	X	79109-1309	-
22	.787	(20.00)	.874	(22.19)	.709	(18.00)	.183	(4.65)	79109-1210	79109-8610	79109-1260	79109-8660	X	79109-1310	-
24	.866	(22.00)	.952	(24.19)	.787	(20.00)	.183	(4.65)	79109-1211	79109-8611	79109-1261	79109-8661	X	79109-1311	-
26	.945	(24.00)	1.031	(26.19)	.866	(22.00)	.183	(4.65)	79109-1212	79109-8612	79109-1262	79109-8662	X	79109-1312	-
28	1.024	(26.00)	1.110	(28.19)	.945	(24.00)	.183	(4.65)	79109-1213	79109-8613	79109-1263	79109-8663	X	79109-1313	-
30	1.102	(28.00)	1.188	(30.19)	1.024	(26.00)	.183	(4.65)	79109-1214	79109-8614	79109-1264	79109-8664	X	79109-1314	-
32	1.181	(30.00)	1.267	(32.19)	1.102	(28.00)	.183	(4.65)	79109-1215	79109-8615	79109-1265	79109-8665	X	79109-1315	-
34	1.260	(32.00)	1.346	(34.19)	1.181	(30.00)	.183	(4.65)	79109-1216	79109-8616	79109-1266	79109-8666	X	79109-1316	-
36	1.338	(34.00)	1.425	(36.19)	1.260	(32.00)	.183	(4.65)	79109-1217	79109-8617	79109-1267	79109-8667	X	79109-1317	-
38	1.417	(36.00)	1.504	(38.19)	1.338	(34.00)	.183	(4.65)	79109-1218	79109-8618	79109-1268	79109-8668	X	79109-1318	-
40	1.496	(38.00)	1.582	(40.19)	1.417	(36.00)	.183	(4.65)	79109-1219	79109-8619	79109-1269	79109-8669	X	79109-1319	-
42	1.575	(40.00)	1.661	(42.19)	1.496	(38.00)	.183	(4.65)	79109-1220	79109-8620	79109-1270	79109-8670	X	79109-1320	-
44	1.654	(42.00)	1.740	(44.19)	1.575	(40.00)	.183	(4.65)	79109-1221	79109-8621	79109-1271	79109-8671	X	79109-1321	-
46	1.732	(44.00)	1.818	(46.19)	1.654	(42.00)	.183	(4.65)	79109-1222	79109-8622	79109-1272	79109-8672	X	79109-1322	-
48	1.811	(46.00)	1.897	(48.19)	1.732	(44.00)	.183	(4.65)	79109-1223	79109-8623	79109-1273	79109-8673	X	79109-1323	-
50	1.890	(48.00)	1.976	(50.19)	1.811	(46.00)	.183	(4.65)	79109-1224	79109-8624	79109-1274	79109-8674	X	79109-1324	-

*X INDICATES TOOLING NOT AVAILABLE

REVISED EC NO: S2010-0566 DRWN:SKANG CHKD:ATSEE APPR:MLONG 2010/01/05 2010/02/03 2010/02/19	QUALITY SYMBOLS	GENERAL TOLERANCES (UNLESS SPECIFIED)	DIMENSION STYLE	SCALE	DESIGN UNITS	THIRD ANGLE PROJECTION	
	$F_A=0$ $F_C=0$ $F_P=0$	mm INCH 4 PLACES ± --- ± --- 3 PLACES ± --- ± .010 2 PLACES ± 0.25 ± .015 1 PLACE ± 0.38 ± --- ANGULAR ± 3 °	IN/MM DRAWN BY DATE AAB 1989/05/15 CHECKED BY DATE MJM 1989/05/15 APPROVED BY DATE MLONG 2010/02/18	NTS TITLE 2MM DUAL ROW VERTICAL RECEPTACLE, SMT			
		DRAFT WHERE APPLICABLE MUST REMAIN WITHIN DIMENSIONS	MATERIAL NO. SEE TABLE	MOLEX MOLEX INCORPORATED			
	M6		SIZE A3 THIS DRAWING CONTAINS INFORMATION THAT IS PROPRIETARY TO MOLEX INCORPORATED AND SHOULD NOT BE USED WITHOUT WRITTEN PERMISSION	DOCUMENT NO. SDA-79109-****			SHEET NO. 5 OF 10

PEG OPTION

SPECIAL PACKAGING (TAPE PACKED WITHOUT CAP)

CKT. SIZE	DIM. "A"		DIM. "B"		DIM. "C"		DIM. "D"		ITEM NO.	PLATING OPTION SEE SHEET 1
	INCH	MM	INCH	MM	INCH	MM	INCH	MM		
50	1.890	(48.00)	1.976	(50.19)	1.811	(46.00)	.183	(4.65)	79109-9103	5

REVISED EC NO: S2010-0566 2010/01/05 DRWN:SKANG 2010/02/03 CHKD:ATSEE 2010/02/19 APPR:MLONG	QUALITY SYMBOLS $F_A=0$ $F_C=0$ $F_P=0$	GENERAL TOLERANCES (UNLESS SPECIFIED) 4 PLACES \pm --- \pm --- 3 PLACES \pm --- \pm .010 2 PLACES \pm 0.25 \pm .015 1 PLACE \pm 0.38 \pm --- ANGULAR \pm 3 °	DIMENSION STYLE IN/MM	SCALE NTS	DESIGN UNITS INCH	THIRD ANGLE PROJECTION	
	DRAWN BY AAB	DATE 1989/05/15	TITLE 2MM DUAL ROW VERTICAL RECEPTACLE, SMT				
	CHECKED BY MJM	DATE 1989/05/15	MOLEX INCORPORATED				
	APPROVED BY MLONG	DATE 2010/02/18	MATERIAL NO. SEE TABLE	DOCUMENT NO. SDA-79109-****	SHEET NO. 6 OF 10		
M6	DRAFT WHERE APPLICABLE MUST REMAIN WITHIN DIMENSIONS	THIS DRAWING CONTAINS INFORMATION THAT IS PROPRIETARY TO MOLEX INCORPORATED AND SHOULD NOT BE USED WITHOUT WRITTEN PERMISSION					

ASSEMBLIES WITH PEGS
VOIDED CIRCUIT OPTION

CKT. SIZE	ASSEMBLY (WITHOUT CAP IN TUBE)	VOID LOCATION(S) SEE SHEET 1 FOR CONVENTION		PLATING OPTION	DIM. "A"		DIM. "B"		DIM. "C"		DIM. "D"	
	ITEM NO.	ROW	CKT. NO.(s)		INCH	MM	INCH	MM	INCH	MM	INCH	MM
48	79109-6011	ROW A	1, 24	5	1.811	(46.00)	1.897	(48.19)	1.732	(44.00)	.183	(4.65)
44	79109-6012	ROW B	10	5	1.654	(42.00)	1.740	(44.19)	1.575	(42.00)	.183	(4.65)

NOTES:

1. TERMINALS WILL BE PRESENT IN VOIDED LOCATIONS. HOWEVER, PIN WINDOWS WILL BE CLOSED.
2. VOIDS CAN ONLY BE PRESENT IN ONE ROW OF A CONNECTOR.

REVISED EC NO: S2010-0566 DRWN:SKANG CHKD:ATSEE APPR:MLONG	2010/01/05 2010/02/03 2010/02/19	DESCRIPTION REV	QUALITY SYMBOLS	GENERAL TOLERANCES (UNLESS SPECIFIED)	DIMENSION STYLE	SCALE	DESIGN UNITS	THIRD ANGLE PROJECTION			
			$F_A=0$ $F_G=0$ $F_P=0$	mm INCH 4 PLACES ± --- ± --- 3 PLACES ± --- ± .010 2 PLACES ± 0.25 ± .015 1 PLACE ± 0.38 ± --- ANGULAR ± 3 °	IN/MM	NTS	INCH	DRAWN BY DATE AAB 1989/05/15 CHECKED BY DATE MJM 1989/05/15 APPROVED BY DATE MLONG 2010/02/18	TITLE 2MM DUAL ROW VERTICAL RECEPTACLE, SMT		
			DRAFT WHERE APPLICABLE MUST REMAIN WITHIN DIMENSIONS	MATERIAL NO. SEE TABLE	MOLEX INCORPORATED			DOCUMENT NO. SDA-79109-****	SHEET NO. 7 OF 10		
			M6	SIZE A3	THIS DRAWING CONTAINS INFORMATION THAT IS PROPRIETARY TO MOLEX INCORPORATED AND SHOULD NOT BE USED WITHOUT WRITTEN PERMISSION						

SPECIAL - CUSTOM TERMINAL FEET

PEG OPTION

CKT. SIZE	DIM. "A"		DIM. "B"		DIM. "C"		DIM. "D"		PLATING OPTION 5			
	INCH	MM	INCH	MM	INCH	MM	INCH	MM	ITEM NO. TUBE PACKED (WITHOUT CAP)	ITEM NO. TAPE PACKED (WITH CAP A)	ITEM NO. TUBE PACKED (WITH CAP A)	
04	.079	(2.00)	.165	(4.19)	-	-	.185	(4.70)	X	-	X 79109-8751	X -
06	.157	(4.00)	.244	(6.19)	.079	(2.00)	.185	(4.70)	X	-	X 79109-8752	X -
08	.236	(6.00)	.322	(8.19)	.157	(4.00)	.185	(4.70)	X	-	X 79109-8753	X -
10	.315	(8.00)	.401	(10.19)	.236	(6.00)	.185	(4.70)	X	-	X 79109-8754	X -
12	.394	(10.00)	.480	(12.19)	.315	(8.00)	.185	(4.70)	X	-	X 79109-8755	X -
14	.472	(12.00)	.559	(14.19)	.394	(10.00)	.185	(4.70)	X	-	X 79109-8756	X -
16	.551	(14.00)	.637	(16.19)	.472	(12.00)	.185	(4.70)	X	-	X 79109-8757	X -
18	.630	(16.00)	.716	(18.19)	.551	(14.00)	.185	(4.70)	X	-	X 79109-8758	X -
20	.709	(18.00)	.795	(20.19)	.630	(16.00)	.185	(4.70)	X	-	X 79109-8759	X -
22	.787	(20.00)	.874	(22.19)	.709	(18.00)	.185	(4.70)	X	-	X 79109-8760	X -
24	.866	(22.00)	.952	(24.19)	.787	(20.00)	.185	(4.70)	X	-	X 79109-8761	X -
26	.945	(24.00)	1.031	(26.19)	.866	(22.00)	.185	(4.70)	X	-	X 79109-8762	X -
28	1.024	(26.00)	1.110	(28.19)	.945	(24.00)	.185	(4.70)	X	-	X 79109-8763	X -
30	1.102	(28.00)	1.188	(30.19)	1.024	(26.00)	.185	(4.70)		79109-7010	79109-8764	X 79109-7065
32	1.181	(30.00)	1.267	(32.19)	1.102	(28.00)	.185	(4.70)	X	-	X 79109-8765	X -
34	1.260	(32.00)	1.346	(34.19)	1.181	(30.00)	.185	(4.70)	X	-	X 79109-8766	X -
36	1.338	(34.00)	1.425	(36.19)	1.260	(32.00)	.185	(4.70)	X	-	X 79109-8767	X -
38	1.417	(36.00)	1.504	(38.19)	1.338	(34.00)	.185	(4.70)	X	-	X 79109-8768	X -
40	1.496	(38.00)	1.582	(40.19)	1.417	(36.00)	.185	(4.70)	X	-	X 79109-8769	X -
42	1.575	(40.00)	1.661	(42.19)	1.496	(38.00)	.185	(4.70)	X	-	X N.A.	X -
44	1.654	(42.00)	1.740	(44.19)	1.575	(40.00)	.185	(4.70)		79109-7016	X N.A.	X -
46	1.732	(44.00)	1.818	(46.19)	1.654	(42.00)	.185	(4.70)	X	-	X N.A.	X -
48	1.811	(46.00)	1.897	(48.19)	1.732	(44.00)	.185	(4.70)	X	-	X N.A.	X -
50	1.890	(48.00)	1.976	(50.19)	1.811	(46.00)	.185	(4.70)		79109-7015	X N.A.	X -

X INDICATES TOOLING NOT AVAILABLE

REVISED EC NO: S2010-0566 DRWN:SKANG CHKD:ATSEE APPR:MLONG 2010/01/05 2010/02/03 2010/02/19	QUALITY SYMBOLS	GENERAL TOLERANCES (UNLESS SPECIFIED)	DIMENSION STYLE	SCALE	DESIGN UNITS	THIRD ANGLE PROJECTION	
	$F_A=0$ $F_C=0$ $F_P=0$	mm INCH 4 PLACES ± --- ± --- 3 PLACES ± --- ± .010 2 PLACES ± 0.25 ± .015 1 PLACE ± 0.38 ± --- ANGULAR ± 3 °	IN/MM	DRAWN BY DATE AAB 1989/05/15 CHECKED BY DATE MJM 1989/05/15 APPROVED BY DATE MLONG 2010/02/18	NTS	INCH	TITLE 2MM DUAL ROW VERTICAL RECEPTACLE, SMT
	M6	DRAFT WHERE APPLICABLE MUST REMAIN WITHIN DIMENSIONS	SEE TABLE	MATERIAL NO. MOLEX INCORPORATED DOCUMENT NO. SDA-79109-****			SHEET NO. 8 OF 10
				SIZE A3 THIS DRAWING CONTAINS INFORMATION THAT IS PROPRIETARY TO MOLEX INCORPORATED AND SHOULD NOT BE USED WITHOUT WRITTEN PERMISSION			

SPECIAL - CUSTOM TERMINAL FEET
VOIDED CIRCUIT OPTION

CKT. SIZE	ASSEMBLY		VOID LOCATION(S) SEE SHEET 1 FOR CONVENTION		PLATING OPTION	DIM. "A"		DIM. "B"		DIM. "C"		DIM. "D"		PEG OPTION
	ITEM NO. TUBE PACKED (WITHOUT CAP)	ITEM NO. TAPE PACKED (WITH CAP A)	ROW	CKT. NO.(s)		INCH	MM	INCH	MM	INCH	MM	INCH	MM	
48	79109-7011	X 79109-8385	ROW A	1, 24	5	1.811	(46.00)	1.897	(48.19)	1.732	(44.00)	.185	(4.70)	YES
42	79109-7012	X 79109-8386	ROW A	1, 21	5	1.575	(40.00)	1.661	(42.19)	1.496	(38.00)	.185	(4.70)	YES
20	79109-7013	79109-8387	ROW A	1, 10	5	.709	(18.00)	.795	(20.19)	.630	(16.00)	.185	(4.70)	YES
50	79109-7014	X 79109-8388	ROW B	13	5	1.890	(48.00)	1.976	(50.19)	1.811	(46.00)	.185	(4.70)	YES
50	79109-7017	79109-8988	ROW B	13	5	1.890	(48.00)	1.976	(50.19)	1.811	(46.00)	.185	(4.70)	NO

X INDICATES TOOLING IS NOT AVAILABLE

NOTES:

1. TERMINALS WILL BE PRESENT IN VOIDED LOCATIONS. HOWEVER, PIN WINDOWS WILL BE CLOSED.
2. VOIDS CAN ONLY BE PRESENT IN ONE ROW OF A CONNECTOR.

REVISED EC NO: S2010-0566 DRWN:SKANG CHKD:ATSEE APPR:MLONG 2010/01/05 2010/02/03 2010/02/19	QUALITY SYMBOLS	GENERAL TOLERANCES (UNLESS SPECIFIED)	DIMENSION STYLE	SCALE	DESIGN UNITS	THIRD ANGLE PROJECTION
	$F_A=0$ $F_C=0$ $F_P=0$	mm INCH 4 PLACES ± --- ± --- 3 PLACES ± --- ± .010 2 PLACES ± 0.25 ± .015 1 PLACE ± 0.38 ± --- ANGULAR ± 3 °	IN/MM	NTS	INCH	
	DESCRIPTION	DRAWN BY	DATE	TITLE		
		AAB	1989/05/15	2MM DUAL ROW VERTICAL RECEPTACLE, SMT		
	CHECKED BY	DATE	MOLEX INCORPORATED			
	MJM	1989/05/15				
	APPROVED BY	DATE	DOCUMENT NO.			
	MLONG	2010/02/18	SDA-79109-****			
	MATERIAL NO.	SEE TABLE		SHEET NO.		
				9 OF 10		
	DRAFT WHERE APPLICABLE MUST REMAIN WITHIN DIMENSIONS	THIS DRAWING CONTAINS INFORMATION THAT IS PROPRIETARY TO MOLEX INCORPORATED AND SHOULD NOT BE USED WITHOUT WRITTEN PERMISSION				
	SIZE	A3				

SPECIAL - ASSEMBLIES WITH CAP B (TAPE PACKED WITH CAP)

PEG OPTION

CKT. SIZE	DIM. "A"		DIM. "B"		DIM. "C"		DIM. "D"		DIM. "E"		ITEM NO.	PLATING OPTION SEE SHEET 1
	INCH	MM	INCH	MM	INCH	MM	INCH	MM	INCH	MM		
8	.236	(6.00)	.322	(8.19)	.157	(4.00)	.183	(4.65)	.065	(1.65)	79109-9108	4
18	.630	(16.00)	.716	(18.19)	.551	(14.00)	.183	(4.65)	.262	(6.65)	79109-9118	4



REVISED EC NO: S2010-0566 DRWN:SKANG CHKD:ATSEE APPR:MLONG 2010/01/05 2010/02/03 2010/02/19	QUALITY SYMBOLS	GENERAL TOLERANCES (UNLESS SPECIFIED)	DIMENSION STYLE	SCALE	DESIGN UNITS	THIRD ANGLE PROJECTION
	$F_A=0$ $F_C=0$ $F_P=0$	mm INCH 4 PLACES ± --- ± --- 3 PLACES ± --- ± .010 2 PLACES ± 0.25 ± .015 1 PLACE ± 0.38 ± --- ANGULAR ± 3 °	IN/MM	NTS	INCH	
	DESCRIPTION	DRAFT WHERE APPLICABLE MUST REMAIN WITHIN DIMENSIONS	DRAWN BY: AAB DATE: 1989/05/15 CHECKED BY: MJM DATE: 1989/05/15 APPROVED BY: MLONG DATE: 2010/02/18	TITLE	2MM DUAL ROW VERTICAL RECEPTACLE, SMT	
	M6	SEE TABLE	MATERIAL NO.	DOCUMENT NO.	SDA-79109-****	
			SIZE A3	THIS DRAWING CONTAINS INFORMATION THAT IS PROPRIETARY TO MOLEX INCORPORATED AND SHOULD NOT BE USED WITHOUT WRITTEN PERMISSION		