

Low-Voltage CMOS Octal Transceiver/Registered Transceiver

With 5V-Tolerant Inputs and Outputs (3-State, Non-Inverting)

The MC74LCX646 is a high performance, non-inverting octal transceiver/registered transceiver operating from a 2.7 to 3.6V supply. High impedance TTL compatible inputs significantly reduce current loading to input drivers while TTL compatible outputs offer improved switching noise performance. A V_I specification of 5.5V allows MC74LCX646 inputs to be safely driven from 5V devices. The MC74LCX646 is suitable for memory address driving and all TTL level bus oriented transceiver applications.

Data on the A or B bus will be clocked into the registers as the appropriate clock pin goes from a LOW-to-HIGH logic level. Output Enable (OE) and DIR pins are provided to control the transceiver outputs. In the transceiver mode, data present at the high impedance port may be stored in either the A or the B register or in both. The select controls (SBA, SAB) can multiplex stored and real-time (transparent mode) data. The direction control (DIR) determines which bus will receive data when the enable OE is active LOW. In the isolation mode (OE HIGH), A data may be stored in the B register or B data may be stored in the A register. Only one of the two buses, A or B, may be driven at one time.

- Designed for 2.7 to 3.6V V_{CC} Operation
- 5V Tolerant — Interface Capability With 5V TTL Logic
- Supports Live Insertion and Withdrawal
- I_{OFF} Specification Guarantees High Impedance When $V_{CC} = 0V$
- LVTTL Compatible
- LVC MOS Compatible
- 24mA Balanced Output Sink and Source Capability
- Near Zero Static Supply Current in All Three Logic States (10 μ A) Substantially Reduces System Power Requirements
- Latchup Performance Exceeds 500mA
- ESD Performance: Human Body Model >2000V; Machine Model >200V

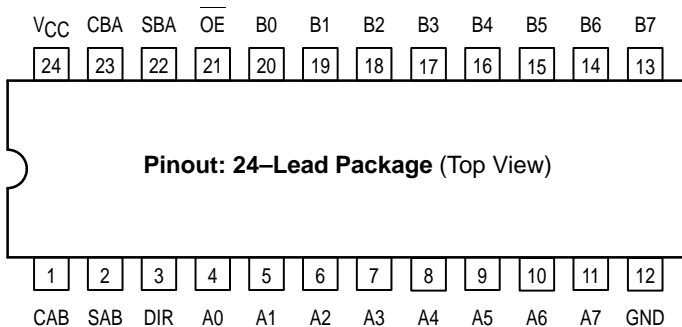

MC74LCX646

LCX

LOW-VOLTAGE CMOS OCTAL TRANSCEIVER/ REGISTERED TRANSCEIVER

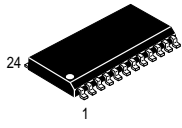

DW SUFFIX
PLASTIC SOIC
CASE 751E-04

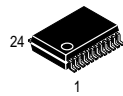

SD SUFFIX
PLASTIC SSOP
CASE 940D-03

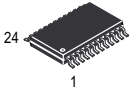

DT SUFFIX
PLASTIC TSSOP
CASE 948H-01

PIN NAMES

Pins	Function
A0–A7	Side A Inputs/Outputs
B0–B7	Side B Inputs/Outputs
CAB, CBA	Clock Pulse Inputs
SAB, SBA	Select Control Inputs
DIR, OE	Output Enable Inputs

MC74LCX646

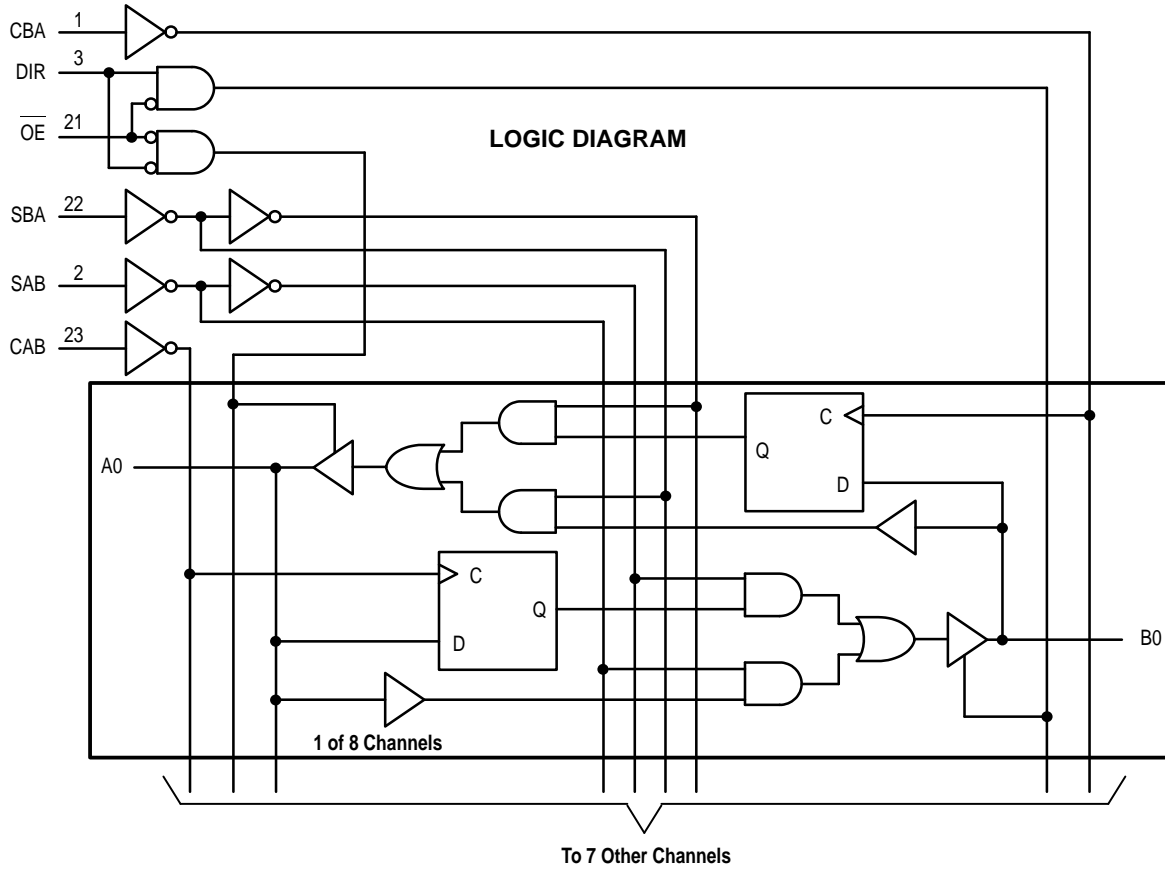

FUNCTION TABLE

Inputs						Data Ports		Operating Mode
OE	DIR	CAB	CBA	SAB	SBA	An	Bn	
H	X					Input	Input	
		↑	↑	X	X	X	X	Isolation, Hold Storage
		↑	↑	X	X	l h X X	X X l h	Store A and/or B Data
L	H					Input	Output	
		↑	X*	L	X	L H	L H	Real Time A Data to B Bus
				H	X	X	QA	Stored A Data to B Bus
		↑	X*	L	X	l h	L H	Real Time A Data to B Bus; Store A Data
				H	X	L H	QA QA	Clock A Data to B Bus; Store A Data
L	L					Output	Input	
		X*	↑	X	L	L H	L H	Real Time B Data to A Bus
				X	H	QB	X	Stored B Data to A Bus
		X*	↑	X	L	L H	l h	Real Time B Data to A Bus; Store B Data
				X	H	QB QB	L H	Clock B Data to A Bus; Store B Data

H = High Voltage Level; h = High Voltage Level One Setup Time Prior to the Low-to-High Clock Transition; L = Low Voltage Level; l = Low Voltage Level One Setup Time Prior to the Low-to-High Clock Transition; X = Don't Care; ↑ = Low-to-High Clock Transition; ↑ = NOT Low-to-High Clock Transition; QA = A input storage register; QB = B input storage register; * = The clocks are not internally gated with either the Output Enables or the Source Inputs. Therefore, data at the A or B ports may be clocked into the storage registers, at any time. For I_{CC} reasons, Do Not Float Inputs.

BUS APPLICATIONS

Real Time Transfer – Bus B to Bus A

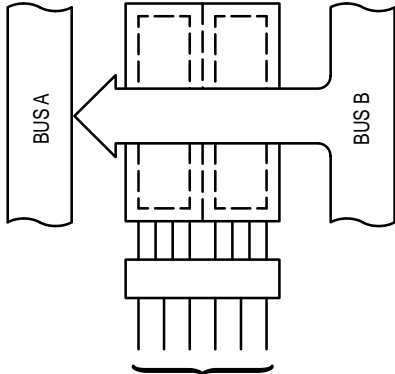

OE	DIR	CAB	CBA	SAB	SBA
L	L	X	X	X	L

Real Time Transfer – Bus A to Bus B

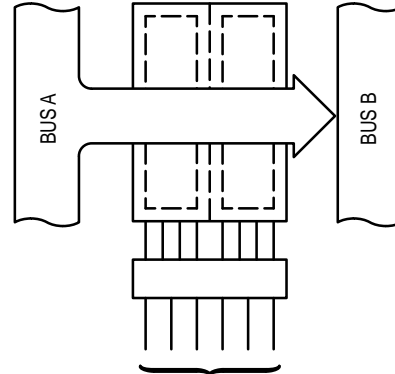

OE	DIR	CAB	CBA	SAB	SBA
L	H	X	X	L	X

Store Data from Bus A, Bus B or Busses A and B

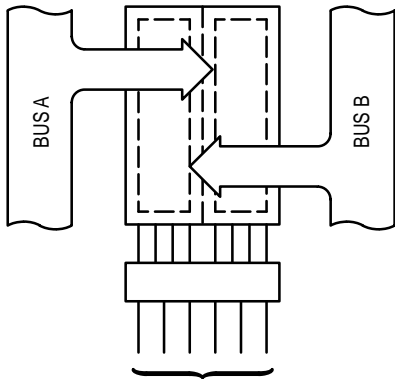

OE	DIR	CAB	CBA	SAB	SBA
X	X	↑	X	X	X
X	X	X	↑	X	X
H	X	↑	↑	X	X

Transfer Storage Data to Bus A or Bus B

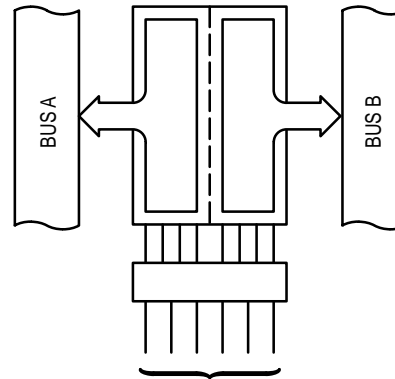

OE	DIR	CAB	CBA	SAB	SBA
L	L	X	H or L	X	H
L	H	H or L	X	H	X

ABSOLUTE MAXIMUM RATINGS*

Symbol	Parameter	Value	Condition	Unit
V _{CC}	DC Supply Voltage	-0.5 to +7.0		V
V _I	DC Input Voltage	-0.5 ≤ V _I ≤ +7.0		V
V _O	DC Output Voltage	-0.5 ≤ V _O ≤ +7.0	Output in 3-State	V
		-0.5 ≤ V _O ≤ V _{CC} + 0.5	Note 1.	V
I _{IK}	DC Input Diode Current	-50	V _I < GND	mA
I _{OK}	DC Output Diode Current	-50	V _O < GND	mA
		+50	V _O > V _{CC}	mA
I _O	DC Output Source/Sink Current	±50		mA
I _{CC}	DC Supply Current Per Supply Pin	±100		mA
I _{GND}	DC Ground Current Per Ground Pin	±100		mA
T _{STG}	Storage Temperature Range	-65 to +150		°C

* Absolute maximum continuous ratings are those values beyond which damage to the device may occur. Exposure to these conditions or conditions beyond those indicated may adversely affect device reliability. Functional operation under absolute-maximum-rated conditions is not implied.

1. Output in HIGH or LOW State. I_O absolute maximum rating must be observed.

RECOMMENDED OPERATING CONDITIONS

Symbol	Parameter	Min	Typ	Max	Unit	
V _{CC}	Supply Voltage	Operating	2.0	3.3	3.6	V
		Data Retention Only	1.5	3.3	3.6	
V _I	Input Voltage	0		5.5	V	
V _O	Output Voltage (HIGH or LOW State) (3-State)	0		V _{CC}	V	
		0		5.5		
I _{OH}	HIGH Level Output Current, V _{CC} = 3.0V – 3.6V			-24	mA	
I _{OL}	LOW Level Output Current, V _{CC} = 3.0V – 3.6V			24	mA	
I _{OH}	HIGH Level Output Current, V _{CC} = 2.7V – 3.0V			-12	mA	
I _{OL}	LOW Level Output Current, V _{CC} = 2.7V – 3.0V			12	mA	
T _A	Operating Free-Air Temperature	-40		+85	°C	
Δt/ΔV	Input Transition Rise or Fall Rate, V _{IN} from 0.8V to 2.0V, V _{CC} = 3.0V	0		10	ns/V	

DC ELECTRICAL CHARACTERISTICS

Symbol	Characteristic	Condition	T _A = -40°C to +85°C		Unit
			Min	Max	
V _{IH}	HIGH Level Input Voltage (Note 2.)	2.7V ≤ V _{CC} ≤ 3.6V	2.0		V
V _{IL}	LOW Level Input Voltage (Note 2.)	2.7V ≤ V _{CC} ≤ 3.6V		0.8	V
V _{OH}	HIGH Level Output Voltage	2.7V ≤ V _{CC} ≤ 3.6V; I _{OH} = -100μA	V _{CC} - 0.2		V
		V _{CC} = 2.7V; I _{OH} = -12mA	2.2		
		V _{CC} = 3.0V; I _{OH} = -18mA	2.4		
		V _{CC} = 3.0V; I _{OH} = -24mA	2.2		
V _{OL}	LOW Level Output Voltage	2.7V ≤ V _{CC} ≤ 3.6V; I _{OL} = 100μA		0.2	V
		V _{CC} = 2.7V; I _{OL} = 12mA		0.4	
		V _{CC} = 3.0V; I _{OL} = 16mA		0.4	
		V _{CC} = 3.0V; I _{OL} = 24mA		0.55	

2. These values of V_I are used to test DC electrical characteristics only.

DC ELECTRICAL CHARACTERISTICS (continued)

Symbol	Characteristic	Condition	T _A = -40°C to +85°C		Unit
			Min	Max	
I _I	Input Leakage Current	2.7V ≤ V _{CC} ≤ 3.6V; 0V ≤ V _I ≤ 5.5V		±5.0	μA
I _{OZ}	3-State Output Current	2.7 ≤ V _{CC} ≤ 3.6V; 0V ≤ V _O ≤ 5.5V; V _I = V _{IH} or V _{IL}		±5.0	μA
I _{OFF}	Power-Off Leakage Current	V _{CC} = 0V; V _I or V _O = 5.5V		10	μA
I _{CC}	Quiescent Supply Current	2.7 ≤ V _{CC} ≤ 3.6V; V _I = GND or V _{CC}		10	μA
		2.7 ≤ V _{CC} ≤ 3.6V; 3.6 ≤ V _I or V _O ≤ 5.5V		±10	μA
ΔI _{CC}	Increase in I _{CC} per Input	2.7 ≤ V _{CC} ≤ 3.6V; V _{IH} = V _{CC} - 0.6V		500	μA

AC CHARACTERISTICS (t_R = t_F = 2.5ns; C_L = 50pF; R_L = 500Ω)

Symbol	Parameter	Waveform	Limits				Unit
			T _A = -40°C to +85°C				
			V _{CC} = 3.0V to 3.6V		V _{CC} = 2.7V		
			Min	Max	Min	Max	
f _{max}	Clock Pulse Frequency	3	150				MHz
t _{PLH} t _{PHL}	Propagation Delay Input to Output	1	1.5	7.0	1.5	8.0	ns
t _{PLH} t _{PHL}	Propagation Delay Clock to Output	3	1.5	8.5	1.5	9.5	ns
t _{PLH} t _{PHL}	Propagation Delay Select to Output	1	1.5	8.5	1.5	9.5	ns
t _{PZH} t _{PZL}	Output Enable Time to High and Low Level	2	1.5	8.5	1.5	9.5	ns
t _{PHZ} t _{PLZ}	Output Disable Time From High and Low Level	2	1.5	8.5	1.5	9.5	ns
t _s	Setup Time, HIGH or LOW Data to Clock	3	2.5		2.5		ns
t _h	Hold Time, HIGH or LOW Data to Clock	3	1.5		1.5		ns
t _w	Clock Pulse Width, HIGH or LOW	3	3.3		3.3		ns
t _{OSSL} t _{OSLH}	Output-to-Output Skew (Note 3.)			1.0			ns

3. Skew is defined as the absolute value of the difference between the actual propagation delay for any two separate outputs of the same device. The specification applies to any outputs switching in the same direction, either HIGH-to-LOW (t_{OSSL}) or LOW-to-HIGH (t_{OSLH}); parameter guaranteed by design.

DYNAMIC SWITCHING CHARACTERISTICS

Symbol	Characteristic	Condition	T _A = +25°C			Unit
			Min	Typ	Max	
V _{OLP}	Dynamic LOW Peak Voltage (Note 4.)	V _{CC} = 3.3V, C _L = 50pF, V _{IH} = 3.3V, V _{IL} = 0V		0.8		V
V _{OLV}	Dynamic LOW Valley Voltage (Note 4.)	V _{CC} = 3.3V, C _L = 50pF, V _{IH} = 3.3V, V _{IL} = 0V		0.8		V

4. Number of outputs defined as "n". Measured with "n-1" outputs switching from HIGH-to-LOW or LOW-to-HIGH. The remaining output is measured in the LOW state.

CAPACITIVE CHARACTERISTICS

Symbol	Parameter	Condition	Typical	Unit
C _{IN}	Input Capacitance	V _{CC} = 3.3V, V _I = 0V or V _{CC}	7	pF
C _{I/O}	Input/Output Capacitance	V _{CC} = 3.3V, V _I = 0V or V _{CC}	8	pF
C _{PD}	Power Dissipation Capacitance	10MHz, V _{CC} = 3.3V, V _I = 0V or V _{CC}	25	pF

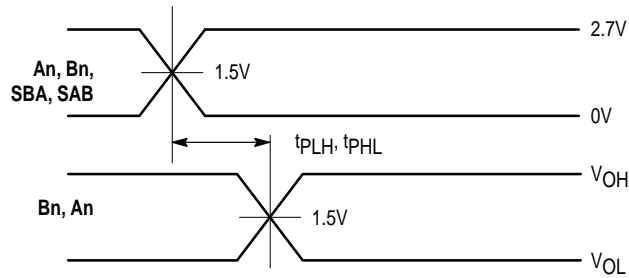

WAVEFORM 1 – SAB to B and SBA to A, An to Bn PROPAGATION DELAYS
 $t_R = t_F = 2.5\text{ns}$, 10% to 90%; $f = 1\text{MHz}$; $t_W = 500\text{ns}$

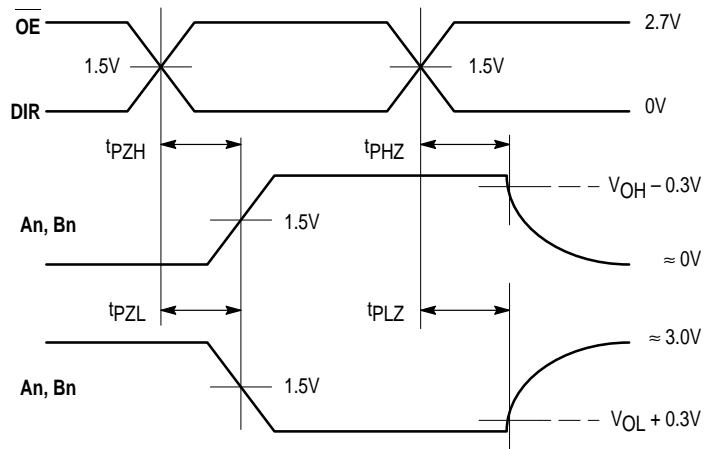

WAVEFORM 2 – OE/DIR to An/Bn OUTPUT ENABLE AND DISABLE TIMES
 $t_R = t_F = 2.5\text{ns}$, 10% to 90%; $f = 1\text{MHz}$; $t_W = 500\text{ns}$

Figure 1. AC Waveforms

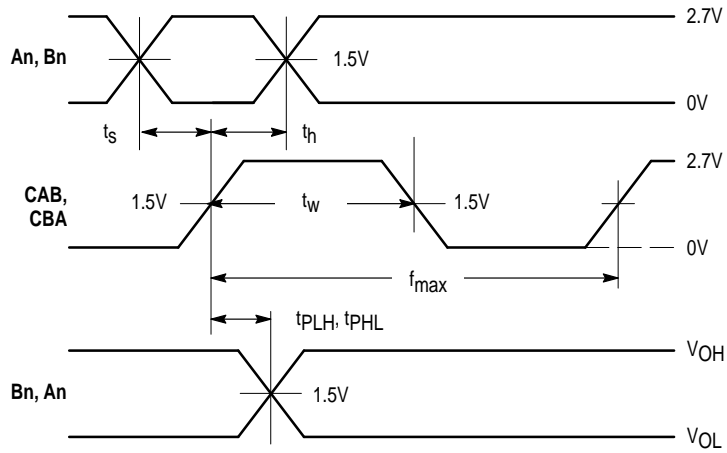

WAVEFORM 3 – CLOCK to Bn/An PROPAGATION DELAYS, CLOCK MINIMUM PULSE WIDTH, An/Bn to CLOCK SETUP AND HOLD TIMES

$t_R = t_F = 2.5\text{ns}$, 10% to 90%; $f = 1\text{MHz}$; $t_W = 500\text{ns}$ except when noted

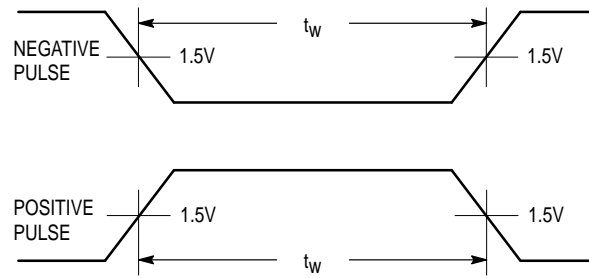

WAVEFORM 4 – INPUT PULSE DEFINITION

$t_R = t_F = 2.5\text{ns}$, 10% to 90% of 0V to 2.7V

Figure 2. AC Waveforms

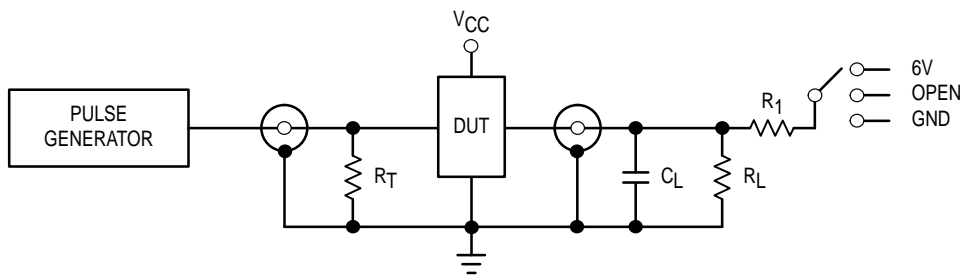

TEST	SWITCH
t_{PLH} , t_{PHL}	Open
t_{PZL} , t_{PLZ}	6V
Open Collector/Drain t_{PLH} and t_{PHL}	6V
t_{PZH} , t_{PHZ}	GND

$C_L = 50\text{pF}$ or equivalent (Includes jig and probe capacitance)
 $R_L = R_1 = 500\Omega$ or equivalent
 $R_T = Z_{OUT}$ of pulse generator (typically 50Ω)

Figure 3. Test Circuit

OUTLINE DIMENSIONS

DW SUFFIX
PLASTIC SOIC PACKAGE
CASE 751E-04
ISSUE E

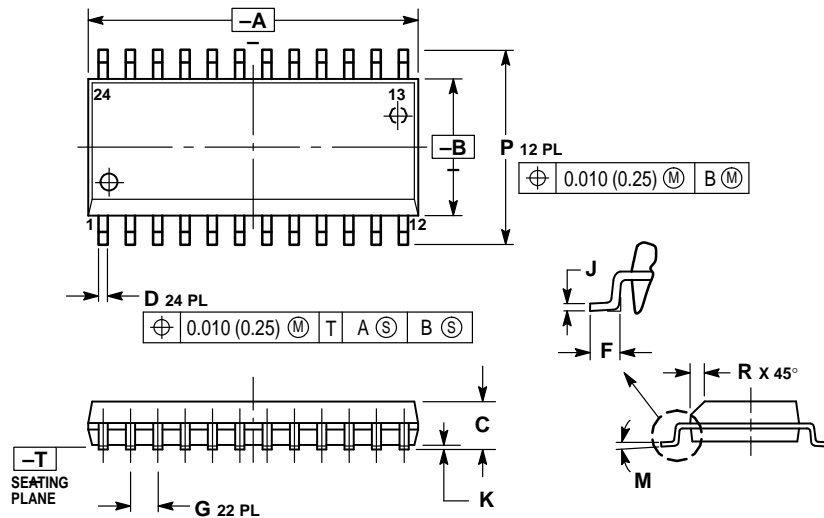

- NOTES:
1. DIMENSIONING AND TOLERANCING PER ANSI Y14.5M, 1982.
 2. CONTROLLING DIMENSION: MILLIMETER.
 3. DIMENSIONS A AND B DO NOT INCLUDE MOLD PROTRUSION.
 4. MAXIMUM MOLD PROTRUSION 0.15 (0.006) PER SIDE.
 5. DIMENSION D DOES NOT INCLUDE DAMBAR PROTRUSION. ALLOWABLE DAMBAR PROTRUSION SHALL BE 0.13 (0.005) TOTAL IN EXCESS OF D DIMENSION AT MAXIMUM MATERIAL CONDITION.

DIM	MILLIMETERS		INCHES	
	MIN	MAX	MIN	MAX
A	15.25	15.54	0.601	0.612
B	7.40	7.60	0.292	0.299
C	2.35	2.65	0.093	0.104
D	0.35	0.49	0.014	0.019
F	0.41	0.90	0.016	0.035
G	1.27 BSC		0.050 BSC	
J	0.23	0.32	0.009	0.013
K	0.13	0.29	0.005	0.011
M	0°	8°	0°	8°
P	10.05	10.55	0.395	0.415
R	0.25	0.75	0.010	0.029

SD SUFFIX
PLASTIC SSOP PACKAGE
CASE 940D-03
ISSUE B

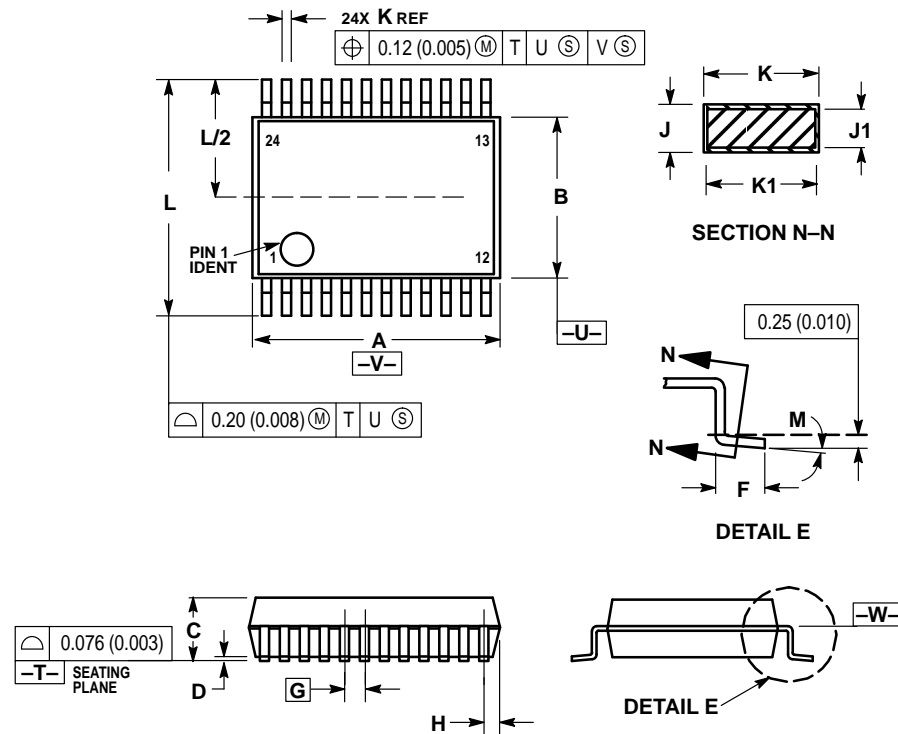

- NOTES:
- 4 DIMENSIONING AND TOLERANCING PER ANSI Y14.5M, 1982.
 - 5 CONTROLLING DIMENSION: MILLIMETER.
 - 6 DIMENSION A DOES NOT INCLUDE MOLD FLASH, PROTRUSIONS OR GATE BURRS. MOLD FLASH OR GATE BURRS SHALL NOT EXCEED 0.15 (0.006) PER SIDE.
 - 7 DIMENSION B DOES NOT INCLUDE INTERLEAD FLASH OR PROTRUSION. INTERLEAD FLASH OR PROTRUSION SHALL NOT EXCEED 0.15 (0.006) PER SIDE.
 - 8 DIMENSION K DOES NOT INCLUDE DAMBAR PROTRUSION/INTRUSION. ALLOWABLE DAMBAR PROTRUSION SHALL BE 0.13 (0.005) TOTAL IN EXCESS OF K DIMENSION AT MAXIMUM MATERIAL CONDITION. DAMBAR INTRUSION SHALL NOT REDUCE DIMENSION K BY MORE THAN 0.07 (0.002) AT LEAST MATERIAL CONDITION.
 - 9 TERMINAL NUMBERS ARE SHOWN FOR REFERENCE ONLY.
 - 10 DIMENSION A AND B ARE TO BE DETERMINED AT DATUM PLANE -W-.

DIM	MILLIMETERS		INCHES	
	MIN	MAX	MIN	MAX
A	8.07	8.33	0.317	0.328
B	5.20	5.38	0.205	0.212
C	1.73	1.99	0.068	0.078
D	0.05	0.21	0.002	0.008
F	0.63	0.95	0.024	0.037
G	0.65 BSC		0.026 BSC	
H	0.44	0.60	0.017	0.024
J	0.09	0.20	0.003	0.008
J1	0.09	0.16	0.003	0.006
K	0.25	0.38	0.010	0.015
K1	0.25	0.33	0.010	0.013
L	7.65	7.90	0.301	0.311
M	0°	8°	0°	8°

OUTLINE DIMENSIONS

DT SUFFIX
 PLASTIC TSSOP PACKAGE
 CASE 948H-01
 ISSUE O

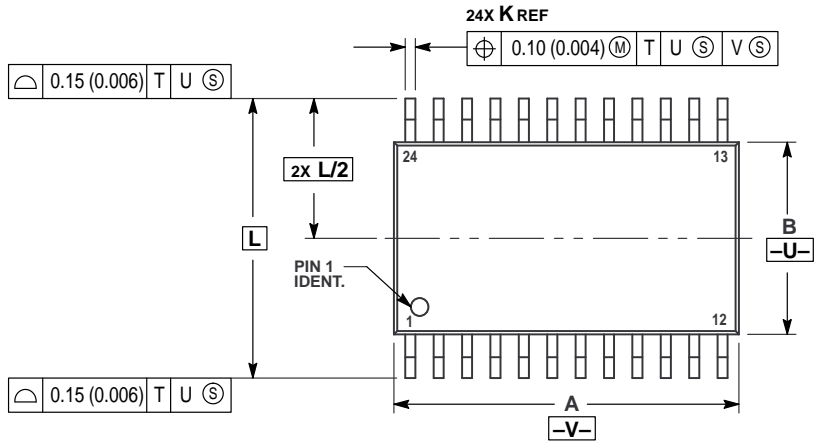

- NOTES:
- 1 DIMENSIONING AND TOLERANCING PER ANSI Y14.5M, 1982.
 - 2 CONTROLLING DIMENSION: MILLIMETER.
 - 3 DIMENSION A DOES NOT INCLUDE MOLD FLASH, PROTRUSIONS OR GATE BURRS. MOLD FLASH OR GATE BURRS SHALL NOT EXCEED 0.15 (0.006) PER SIDE.
 - 4 DIMENSION B DOES NOT INCLUDE INTERLEAD FLASH OR PROTRUSION. INTERLEAD FLASH OR PROTRUSION SHALL NOT EXCEED 0.25 (0.010) PER SIDE.
 - 5 DIMENSION K DOES NOT INCLUDE DAMBAR PROTRUSION. ALLOWABLE DAMBAR PROTRUSION SHALL BE 0.08 (0.003) TOTAL IN EXCESS OF THE K DIMENSION AT MAXIMUM MATERIAL CONDITION.
 - 6 TERMINAL NUMBERS ARE SHOWN FOR REFERENCE ONLY.
 - 7 DIMENSION A AND B ARE TO BE DETERMINED AT DATUM PLANE -W-.

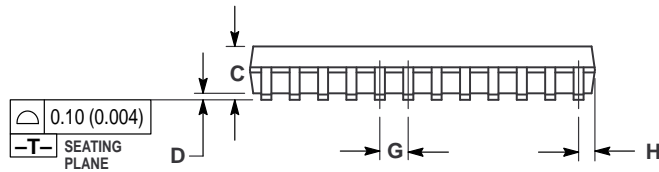

DIM	MILLIMETERS		INCHES	
	MIN	MAX	MIN	MAX
A	7.70	7.90	0.303	0.311
B	4.30	4.50	0.169	0.177
C	—	1.20	—	0.047
D	0.05	0.15	0.002	0.006
F	0.50	0.75	0.020	0.030
G	0.65 BSC		0.026 BSC	
H	0.27	0.37	0.011	0.015
J	0.09	0.20	0.004	0.008
J1	0.09	0.16	0.004	0.006
K	0.19	0.30	0.007	0.012
K1	0.19	0.25	0.007	0.010
L	6.40 BSC		0.252 BSC	
M	0°	8°	0°	8°

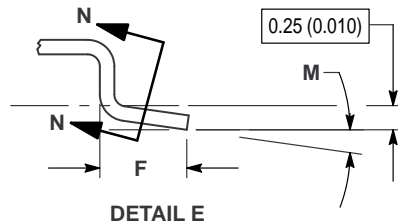
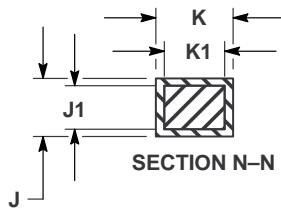
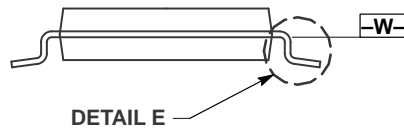

Motorola reserves the right to make changes without further notice to any products herein. Motorola makes no warranty, representation or guarantee regarding the suitability of its products for any particular purpose, nor does Motorola assume any liability arising out of the application or use of any product or circuit, and specifically disclaims any and all liability, including without limitation consequential or incidental damages. "Typical" parameters which may be provided in Motorola data sheets and/or specifications can and do vary in different applications and actual performance may vary over time. All operating parameters, including "Typicals" must be validated for each customer application by customer's technical experts. Motorola does not convey any license under its patent rights nor the rights of others. Motorola products are not designed, intended, or authorized for use as components in systems intended for surgical implant into the body, or other applications intended to support or sustain life, or for any other application in which the failure of the Motorola product could create a situation where personal injury or death may occur. Should Buyer purchase or use Motorola products for any such unintended or unauthorized application, Buyer shall indemnify and hold Motorola and its officers, employees, subsidiaries, affiliates, and distributors harmless against all claims, costs, damages, and expenses, and reasonable attorney fees arising out of, directly or indirectly, any claim of personal injury or death associated with such unintended or unauthorized use, even if such claim alleges that Motorola was negligent regarding the design or manufacture of the part. Motorola and  are registered trademarks of Motorola, Inc. Motorola, Inc. is an Equal Opportunity/Affirmative Action Employer.

How to reach us:

USA/EUROPE/Locations Not Listed: Motorola Literature Distribution;
P.O. Box 5405, Denver, Colorado 80217. 1-800-441-2447

Mfax™: RMFAX0@email.sps.mot.com – TOUCHTONE 602-244-6609
INTERNET: <http://Design-NET.com>

JAPAN: Nippon Motorola Ltd.; Tatsumi-SPD-JLDC, 6F Seibu-Butsuryu-Center,
3-14-2 Tatsumi Koto-Ku, Tokyo 135, Japan. 03-81-3521-8315

ASIA/PACIFIC: Motorola Semiconductors H.K. Ltd.; 8B Tai Ping Industrial Park,
51 Ting Kok Road, Tai Po, N.T., Hong Kong. 852-26629298

