

C&K BY Series

4 Tumbler Value Added Security Switchlocks



Features/Benefits

- **Anti-static switch**
- **Removable lock core**
- **Latch pawl option**
- **Snap-together assembly**

Typical Applications

- **Computers**
- **Point-of-sale terminals**
- **Postal equipment**



Specifications

CONTACT RATING: Q contact material: 4 AMPS @ 125 V AC or 28 V DC; 2 AMPS @ 250 V AC (UL/CSA). Low level models with gold plating available. See page M-26 for additional ratings.

ELECTRICAL LIFE: 10,000 make-and-break cycles at full load.

CONTACT RESISTANCE: Below 10 mΩ typ. initial @ 2-4 V DC, 100 mA, for both silver and gold plated contacts.

INSULATION RESISTANCE: 10⁹ Ω min.

DIELECTRIC STRENGTH: 1,000 Vrms min. @ sea level.

INDEXING: 45° or 90°, 2-3 positions. Other functions available, consult Customer Service Center.

STATIC RESISTANCE: Anti-static models exceed 20 KV DC static resistance @ sea level, lock body to terminals.

NOTE: Any models supplied with Q, B or G contact material are RoHS compliant. For the latest information regarding RoHS compliance, please go to: www.ittcannon.com/rohs.

NOTE: Specifications and materials listed above are for switchlocks with standard options. For information on specific and custom switchlocks, consult Customer Service Center.

Materials

LOCK: 4 tumbler lock with positive detent. Shell-zinc alloy; Core-ABS plastic, black, std.; Facing-ABS plastic, black.

KEYS: Two nickel plated brass keys with code number. Plastic key cover, black.

SWITCH HOUSING: Glass filled polyester (UL 94V-0).

CONTACTS & TERMINALS: Q contact material: Copper, silver plated. See page M-26 for additional contact materials.

MOUNTING NUT: Zinc alloy.

MOUNTING CLIP: Steel, zinc plated.

TERMINAL SEAL: Epoxy.

Build-A-Switch

To order, simply select desired option from each category and place in the appropriate box. Available options are shown and described on pages M-23 through M-26. For additional options not shown in catalog, consult Customer Service Center.



Switch and Lock Function

- BY011U** SP, 90°, Index, keypull pos. 1 & 2
- BY211U** DP, 90° Index, keypull pos. 1 & 2
- BY01AF** SP, 45° Index, keypull pos. 1, 2 & 3
- BY21AF** DP, 45° Index, keypull pos. 1, 2 & 3

Keying

- J** One plastic round head key and one nickel plated key
- 2** Two nickel plated keys

Lock Type

- C** 4 Tumbler lock with detent

Terminations

- 03** Solder lug with hole
- WC** Wire lead

Mounting Style

- N** With nut
- D** With clip
- L** With latch pawl and nut
- M** With latch pawl and clip

Contact Material

- Q** Silver
- B** Gold
- G** Gold over silver

Lock Color

- 2** Black

Key Color

- 2** Black
- NONE** Nickel plated brass



Switchlock



Dimensions are shown: Inch (mm)
Specifications and dimensions subject to change

C&K BY Series 4 Tumbler Value Added Security Switchlocks

SWITCH AND LOCK FUNCTION

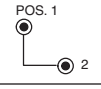
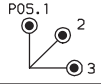
	NO. POLES	MODEL NO.	CONNECTED TERMINALS			KEY PULL POSITIONS	LOCK CONFIGURATION	INDEXING
			POS. 1	POS. 2	POS. 3			
WITHOUT PAWL	SP DP	BY011U BY211U	8-1 8-1, 4-5	1-3 1-3, 5-7		Positions 1 & 2		90°
	SP DP	BY01AF BY21AF	8-1 8-1, 4-5	1-2 1-2, 5-6	2-3 2-3, 3-4	Positions 1, 2 & 3		45°

Without Pawl

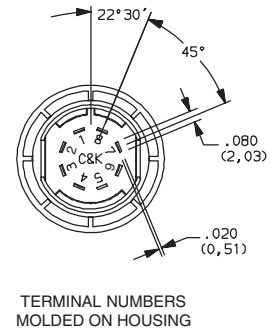
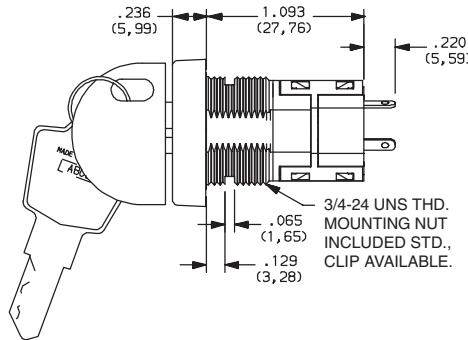
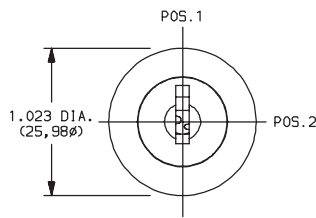

Part number shown: BY011UJC03NQ22

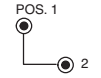
WITH PAWL	SP DP	BY011U BY211U	6-7 6-7, 2-3	7-1 7-1, 3-5		Positions 1 & 2		90°
-----------	----------	--------------------------------	-----------------	-----------------	--	-----------------	---	-----

With Pawl

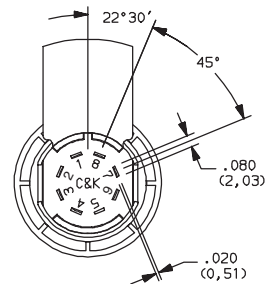
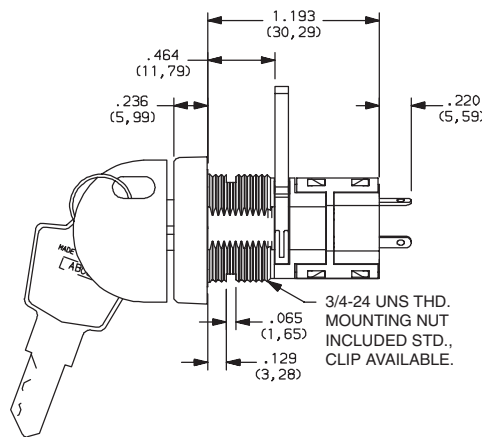
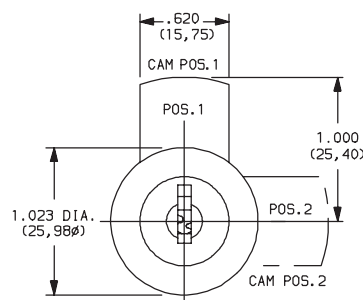



90 Indexing-2 positions with pawl
Pos. 1: SP: 6-7, DP: 6-7, 2-3;
Pos. 2: SP: 7-1, DP: 7-1, 3-5

Part number shown: BY011UJC03LQ22

LEGEND

- = Detent Positions (45° or 90°)
- ⊙ = Key pull possible in these positions.
- ⊖ = Stop Positions

All models   with all options when ordered with 'G' or 'Q' contact material.

TERMINAL NUMBERS

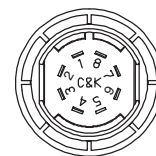

Terminal numbers molded on housing.

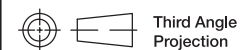

Switchlock

C&K BY Series 4 Tumbler Value Added Security Switchlocks

SWITCH AND LOCK FUNCTION

	NO. POLES	MODEL NO.	CONNECTED TERMINALS			KEY PULL POSITIONS	LOCK CONFIGURATION	INDEXING
			POS. 1	POS. 2	POS. 3			
WITH PAWL	SP DP	BY01AF BY21AF	8-1 8-1, 4-5	1-2 1-2, 5-6	7-8 7-8, 3-4	Positions 1, 2 & 3		45°

With Pawl

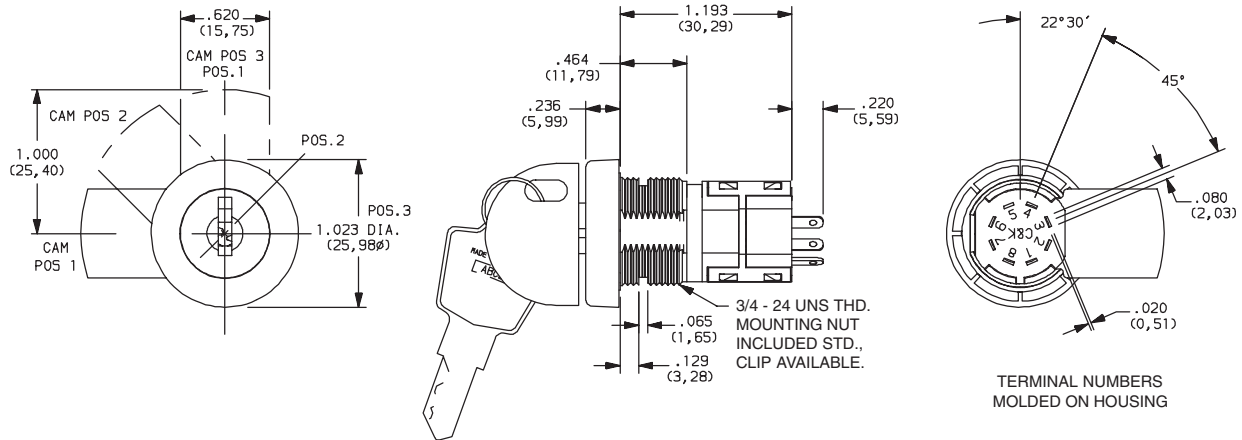

Part number shown: BY01AFJC03LQ22

LEGEND

- = Detent Positions (45° or 90°)
- ⊙ = Key pull possible in these positions.
- ▼ ● = Stop Positions

TERMINAL NUMBERS

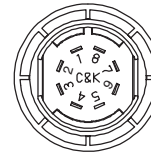

All models with all options when ordered with 'G' or 'Q' contact material.

Terminal numbers molded on housing.

KEYING

OPTION CODE	KEYING OPTIONS	CODE NO. ON KEY	CODE NO. ON LOCK
J	1 PLASTIC ROUND HEAD KEY, 1 NICKEL PLATED BRASS KEY	YES	NO
2	2 NICKEL PLATED BRASS KEYS	YES	NO

NOTE: Keys available separately, see page M-26.

OPTION CODE	KEY COLOR
NONE	NICKEL PLATED BRASS
2	BLACK

NICKEL PLATED BRASS KEY

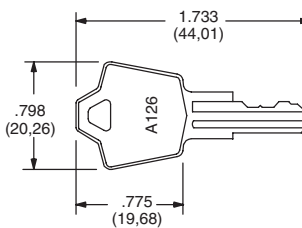

Key part number:
115140126

NICKEL PLATED BRASS KEY WITH PLASTIC INSERT MOLDED ROUND HEAD

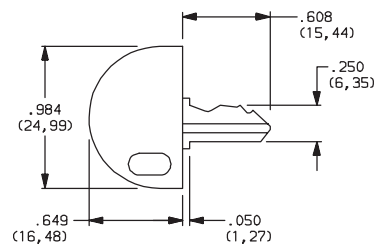

Key part number:
16564112602

NOTE: Key head shape subject to change without notice.



Third Angle
Projection

Dimensions are shown: Inch (mm)
Specifications and dimensions subject to change



M

Switchlock

C&K BY Series 4 Tumbler Value Added Security Switchlocks

LOCK TYPE

C 4 TUMBLER LOCK WITH DETENT

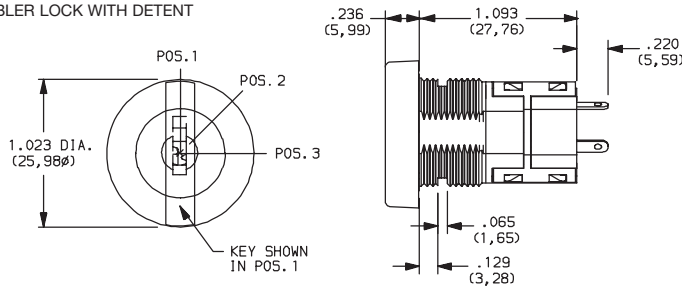

OPTION CODE	LOCK COLOR
2	BLACK

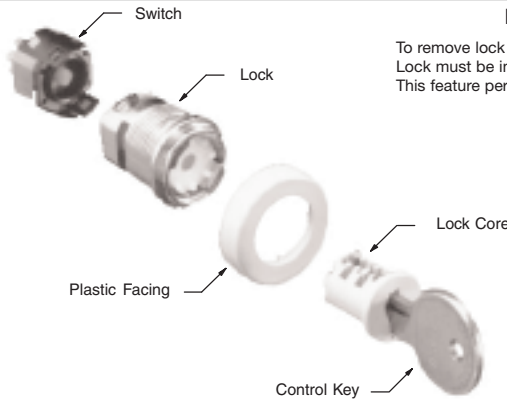

Lock Core Removal Instructions

To remove lock core, insert round-headed control key and pull. Lock must be in position 2 (90° indexing), position 3 (45° indexing). This feature permits changing key codes.

BRASS CONTROL KEY

(Removes lock core)

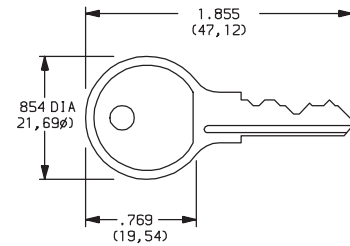

Control key available separately, part number: 11630CKBYST

TERMINATIONS

03 SOLDER LUG WITH HOLE

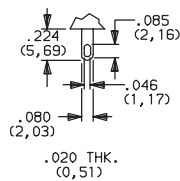

WC WIRE LEAD

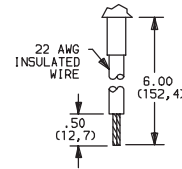

Black wire standard. other colors and lengths available, consult Customer Service Center. UL style 1015.

LOCK TYPE

N WITH NUT

L LATCH PAWL AND NUT

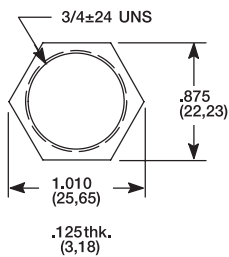

Nut part number: 175050700

D WITH CLIP

M LATCH PAWL AND CLIP

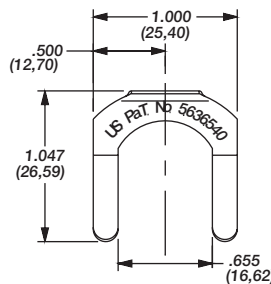
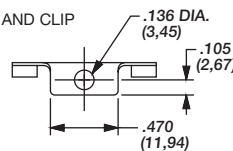

Clip part number: 906B00000

OPTION CODE	MOUNTING STYLE	PANEL THICKNESS
N, L	WITH NUT	.085-.105 (2,16-2,67)
D, M	WITH CLIP	.085-.105 (2,16-2,67)

PANEL MOUNTING

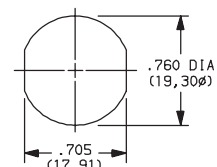

Models with latch pawl

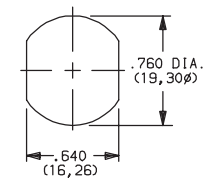

Models without latch pawl



Third Angle Projection

Dimensions are shown: Inch (mm)
Specifications and dimensions subject to change



M

Switchlock

C&K BY Series

4 Tumbler Value Added Security Switchlocks

CONTACT MATERIAL



OPTION CODE	RoHS COMPLIANT*	RoHS COMPATIBLE*	CONTACT AND TERMINAL MATERIAL	RATING	
Q	YES	YES	SILVER ²	POWER	4 AMPS @ 125 V AC or 28 V DC; 2 AMPS @ 250 V AC (UL/CSA).
B	YES	YES	GOLD ¹	LOW LEVEL/DRY CIRCUIT	0.4 VA MAX. @ 20 V AC or DC MAX
G	YES	YES	GOLD SILVER ³	LOW LEVEL/DRY CIRCUIT OR POWER	0.4 VA MAX. @ 20 V AC or DC MAX. or 4 AMPS @ 125 V AC or 28 V DC; 2 AMPS @ 250 V AC (UL/CSA)

* Note: See Technical Data section of this catalog for RoHS compliant and compatible definitions and specifications.

¹ CONTACTS & TERMINALS: Copper, with gold plate over nickel plate.

² CONTACTS & TERMINALS: Copper, silver plated (standard with all termination options).

³ CONTACTS & TERMINALS: Copper, with gold plate over silver plate.

All models   with all options when ordered with 'G' or 'Q' contact material.

NOTE: 'G' contact material is equivalent to both 'B' and 'Q' contact materials.

AVAILABLE HARDWARE



Key Code: A126
PART NO. (ONE KEY)
115140126
Material: Brass
Finish: Nickel plate



Key Code: A126
PART NO. (ONE KEY)
16564112602 BLACK
Material: Brass
Finish: Nickel plate
 6/6 Nylon insert molded head

Control key (removes lock core)



Key Code: 3434
PART NO. (ONE KEY)
11630CKBYST
Material: Brass
Finish: None



Switchlock

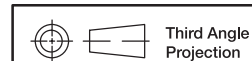

Dimensions are shown: Inch (mm)
 Specifications and dimensions subject to change