

1.78:1 step up flux coupled transformer
0.3-200MHz

MABA-008482-CF1A40
V1

Features

- Surface mount
- 1.78:1 step-up flux coupled transformer
- Separate secondary coils, allowing separate bias feed into balanced amplifiers
- 260°C reflow compatible
- RoHS* compliant
- Part is welded and lead free
- Available on tape and reel. Reel quantity 2000

Description

M/A-COM's MABA-008482-CF1A40 is a 1.78:1 Flux Coupled step up transformer in a low cost, surface mount package. Ideally suited for high volume CATV/Broadband applications. Suitable for use in 50 Ohm and 75 Ohm systems

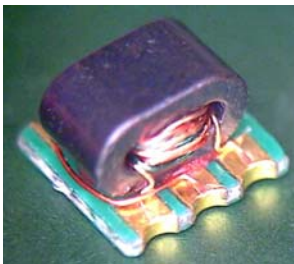

Schematic

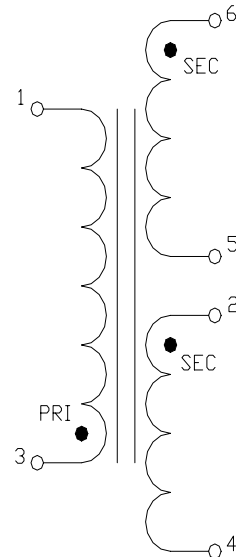

Pin Configuration

Pin No.	Function
1	Primary (ground)
2	Secondary ground 2
3	Primary Dot (input)
4	Secondary (output 2)
5	Secondary ground 1
6	Secondary Dot (output 1)

Case Style: SM-156

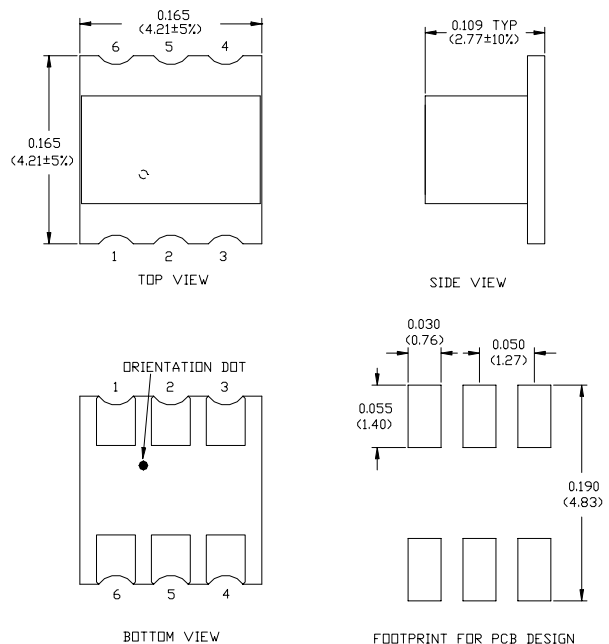

Dimensions in inches [mm] Tolerance: .xx ± .02, .xxx ± .010

Note: Reference Application Note **M513** for reel size information.

* Restrictions on Hazardous Substances, European Union Directive 2002/95/EC.

M/A-COM Inc. and its affiliates reserve the right to make changes to the product(s) or information contained herein without notice. M/A-COM makes no warranty, representation or guarantee regarding the suitability of its products for any particular purpose, nor does M/A-COM assume any liability whatsoever arising out of the use or application of any product(s) or information.

- **North America** Tel: 800.366.2266 / Fax: 978.366.2266
- **Europe** Tel: 44.1908.574.200 / Fax: 44.1908.574.300
- **Asia/Pacific** Tel: 81.44.844.8296 / Fax: 81.44.844.8298

Visit www.macom.com for additional data sheets and product information.

1.78:1 step up flux coupled transformer
0.3-200MHz

MABA-008482-CF1A40
V1

Electrical Specifications: $T_A = 25^\circ\text{C}$, $Z_0 = 75\Omega$ ¹

Parameter	Frequency	Units	Min	Typ	Max
Insertion Loss	0.3 - 5 MHz	dB	-	1.3	1.7
	5 - 80 MHz	dB	-	0.35	0.5
	80-200 MHz	dB	-	0.48	1.0
Amplitude Balance	0.3 - 100 MHz	dB	-	0.02	± 0.2
	100 - 200 MHz	dB	-	0.14	± 0.5
Phase Balance	0.3 - 50 MHz	$^\circ$	-	0.50	± 3
	50 - 100 MHz	$^\circ$	-	1.95	± 5
	100 - 200 MHz	$^\circ$	-	4.15	± 10
Input Return Loss	0.3 - 4 MHz	dB	7	21.2	-
	4 - 100 MHz	dB	22	25.9	-
	100 - 200 MHz	dB	16	18.4	-

Absolute Maximum Ratings ^{1,2}

Parameter	Absolute Maximum
Max RF Power	1W
Max DC current	250mA per arm
Operating Temperature	-40°C to +60°C
Storage Temperature	-40°C to +85°C

Recommended PCB Configuration

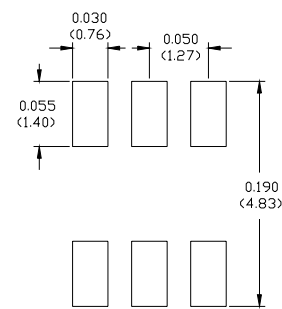

FOOTPRINT FOR PCB DESIGN

1. Exceeding any one or combination of these limits may cause permanent damage to this device.
2. M/A-COM does not recommend sustained operation near these survivability limits.

1.78:1 step up flux coupled transformer
0.3-200MHz

MABA-008482-CF1A40
V1

Typical Performance Curves: $T_A = 25^\circ\text{C}$, $Z_0 = 75\Omega$ ¹

Insertion Loss 1 (pin3 - pin6)

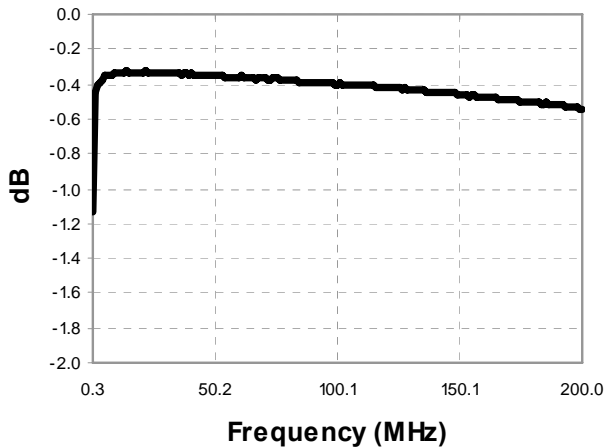

Insertion Loss 2 (pin3 - pin4)

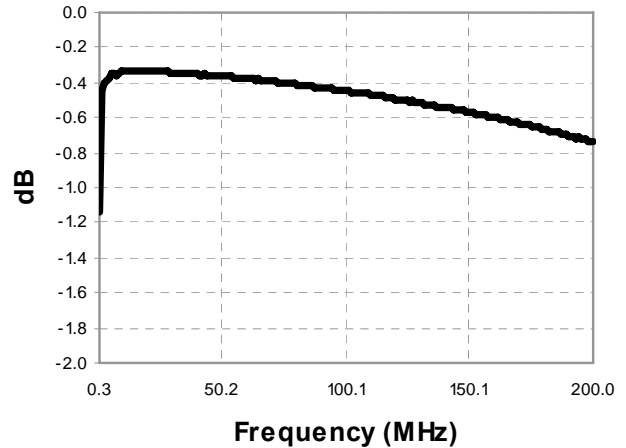

Amplitude Balance

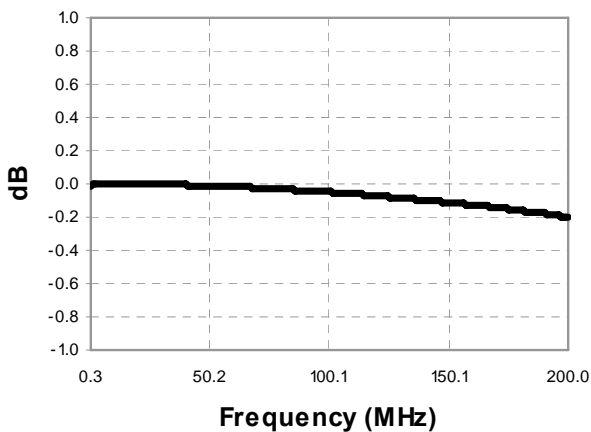

Phase Balance

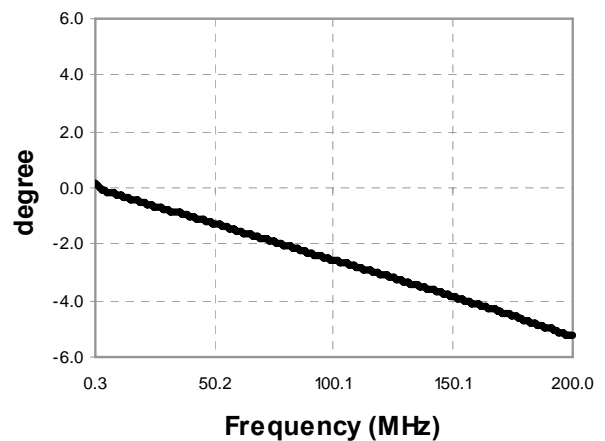

Return Loss: Input

