

Antenna Top



Antenna Bottom



**FXUB70.A.07.C.001**

**Specification**

<b>Part No.</b>	<b>FXUB70.A.07.C.001</b>
<b>Product Name</b>	4G LTE Wide Band Flex MIMO Antenna 698-3000 MHz
<b>Feature</b>	Patent Pending Covers 4G LTE, 3G HSPA, 2G GSM/GPRS/CDMA Ground Plane Independent 698-3000 MHz 5 dBi Peak Gain 182*21*0.2 mm size 150mm Ø1.37mm Cable IPEX MHFI (U.FL Compatible) RoHS Compliant



## 1. Introduction

The patent pending FXUB70 LTE Wide-band flexible wideband antenna has been designed to cover all working frequencies in the 698-3000 MHz spectrum, covering all Cellular, 2.4GHz Wi-Fi, ISM and AGPS. The antenna is delivered with a flexible body with excellent efficiencies on all bands, ground independent, with cable and connector for easy installation.

The FXUB70 flexible polymer antenna, at 182\*21\*0.2mm, is ultra thin and truly wideband with high efficiencies across the bands. It is assembled by a simple “peel and stick” process, attaching securely to non-metal surfaces via 3M 467 automotive approved adhesive. It enables designers to use only one antenna that covers all common frequencies for LTE and 4G globally.

The FXUB70 antenna is a durable flexible polymer antenna that has a peak gain of 5dBi, an efficiency of more than 45% across the bands and is designed to be mounted directly onto a plastics. It is an ideal choice for any device maker that needs to keep manufacturing costs down over the lifetime of a product. It is ground plane independent and delivered with a cable and connector for easy connecting to the wireless module or customer PCB. Like all such antennas, care should be taken to mount the antenna at least 10mm from metal components or surfaces, and ideally 20mm for best radiation efficiency.

Cables and Connectors are customizable. If cable routing is not convenient on this antenna, the alternative FXUB71 is recommended.

## 2. Specification

Band	700/850/900	1575	1700/1800/1900	2100	2400	2600
Standard	CELL	GPS	CELL	CELL	ISM	CELL
Frequency (MHz)	698-960	1575.42	1710-1990	1755-2170	2400-2500	2500-2690
Max VSWR	2:1	2:1	1.8:1	1.7:1	1.7:1	2.3:1
Max Return Loss (dB)	-10	-10	-11	-12	-12	-8
Peak Gain (dBi)	1	2.5	3.5	5	5	4.5
Efficiency (%)	50	75	78	65	75	75
Average Gain (dB)	-3	-2	-2	-2.5	-2	-2
Radiation Properties	Omni-directional					
Max Input Power (Watts)	5					
Polarization	Linear					
Impedance (Ohms)	50 Ohms					

\*Antenna measured on plastic plate of 3 mm thickness.

MECHANICAL	
Dimensions (mm)	182*21*0.2 mm
Material	Flexible Polymer
Connector and Cable	U.FL and 1.37 mm mini coax with 150 mm
Cable length	150 mm
ENVIRONMENTAL	
Operation Temperature	-40°C to +85°C
Storage Temperature	-40°C to +85°C
Relative Humidity	40% to 95%
RoHS Compliant	Yes

### 3. Antenna Parameters

#### 3.1 Return Loss

Figure 1. Return loss of FXUB70 Port 1

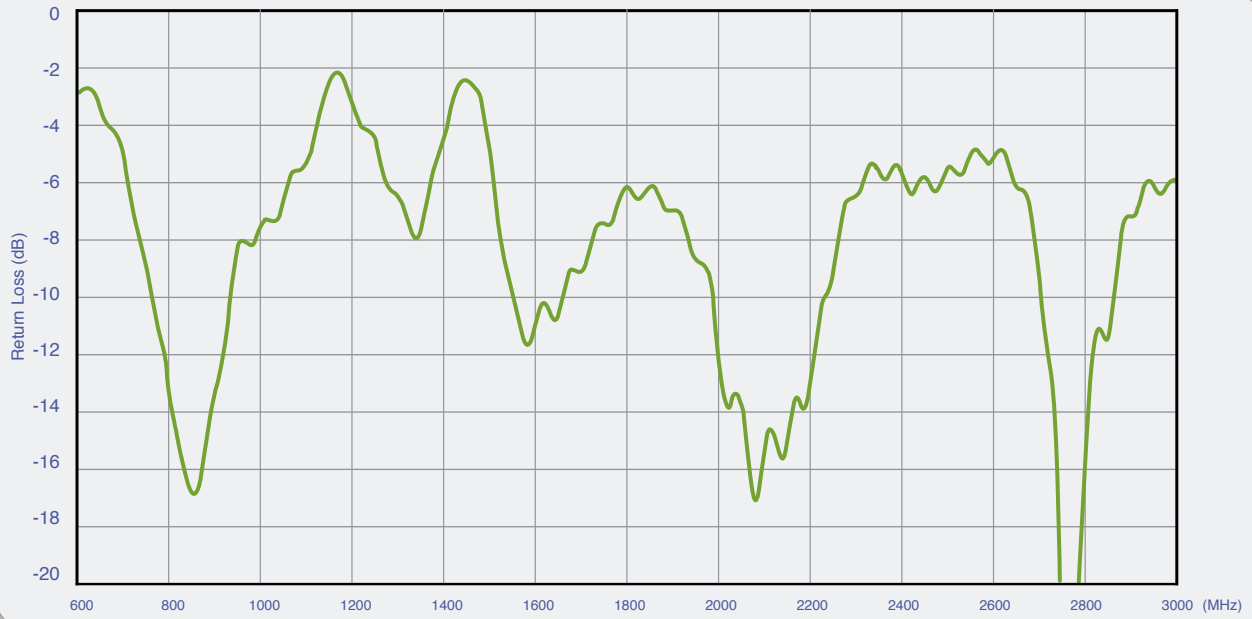
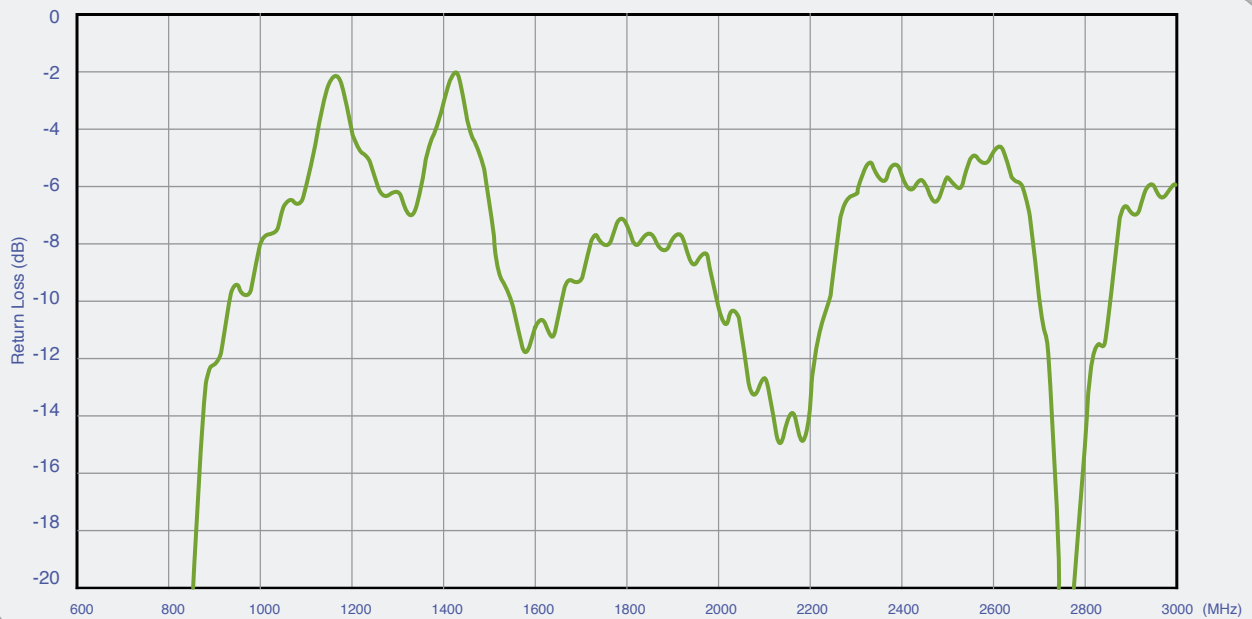

Figure 2. Return loss of FXUB70 Port 2



### 3. Antenna Parameters

#### 3.2 VSWR

Figure 3. VSWR of FXUB70 Port 1

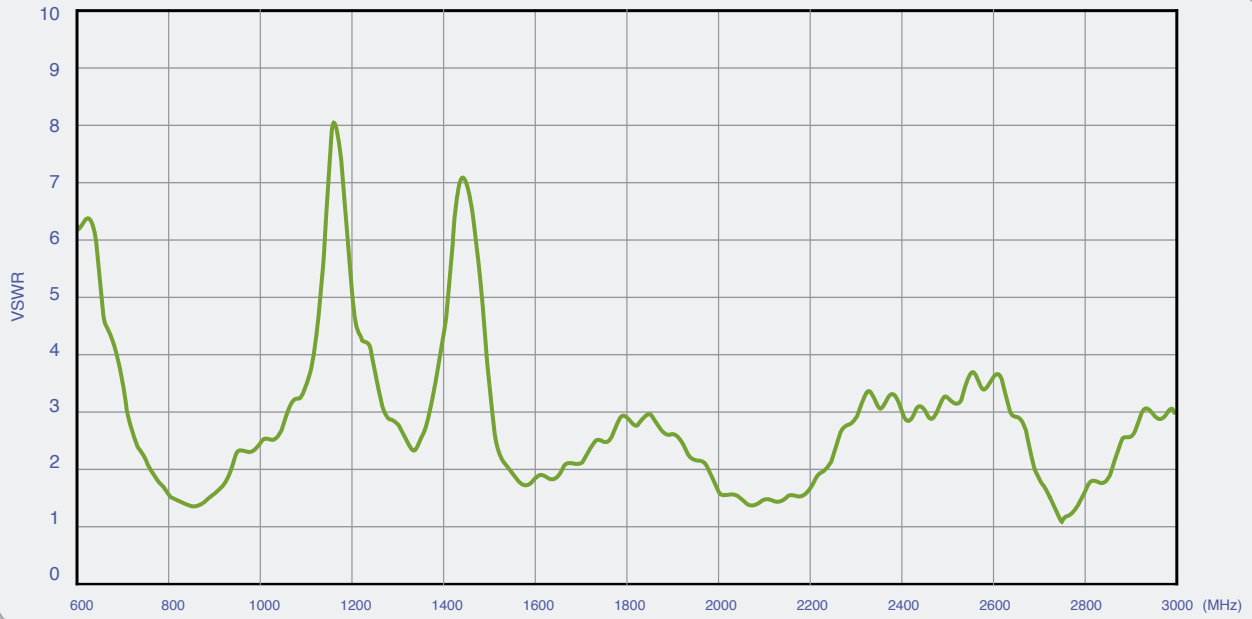
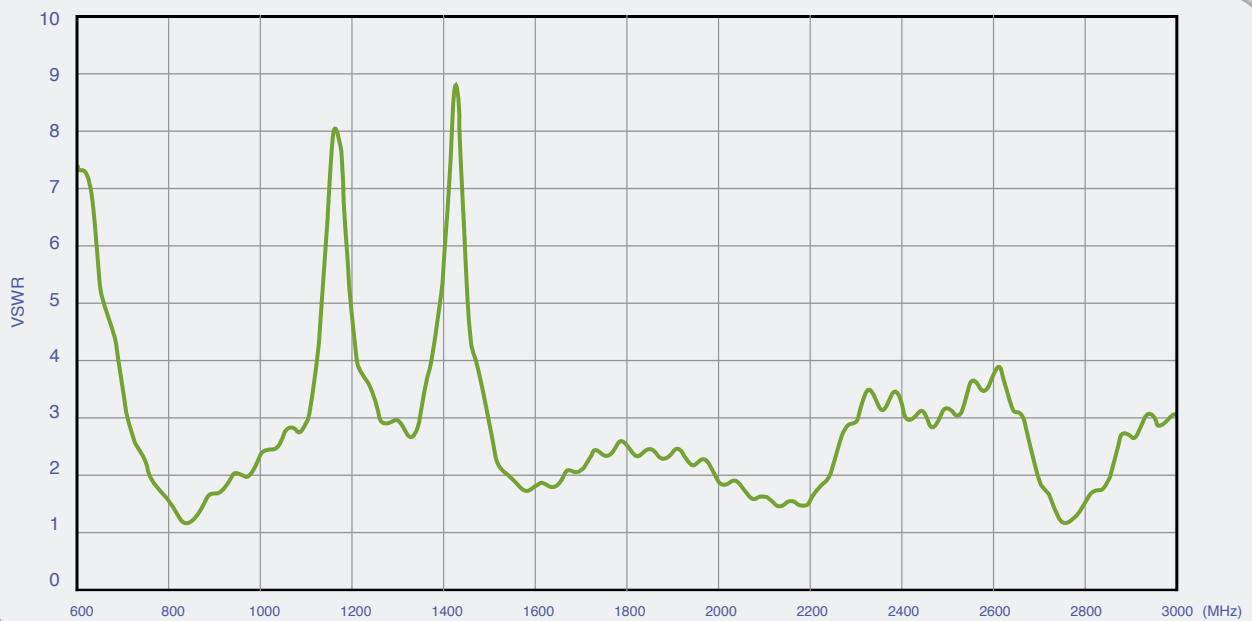

Figure 4. VSWR of FXUB70 Port 2



### 3. Antenna Parameters

#### 3.3. Isolation

Figure 5. Isolation of FXUB70 in between Port 1 and Port 2.

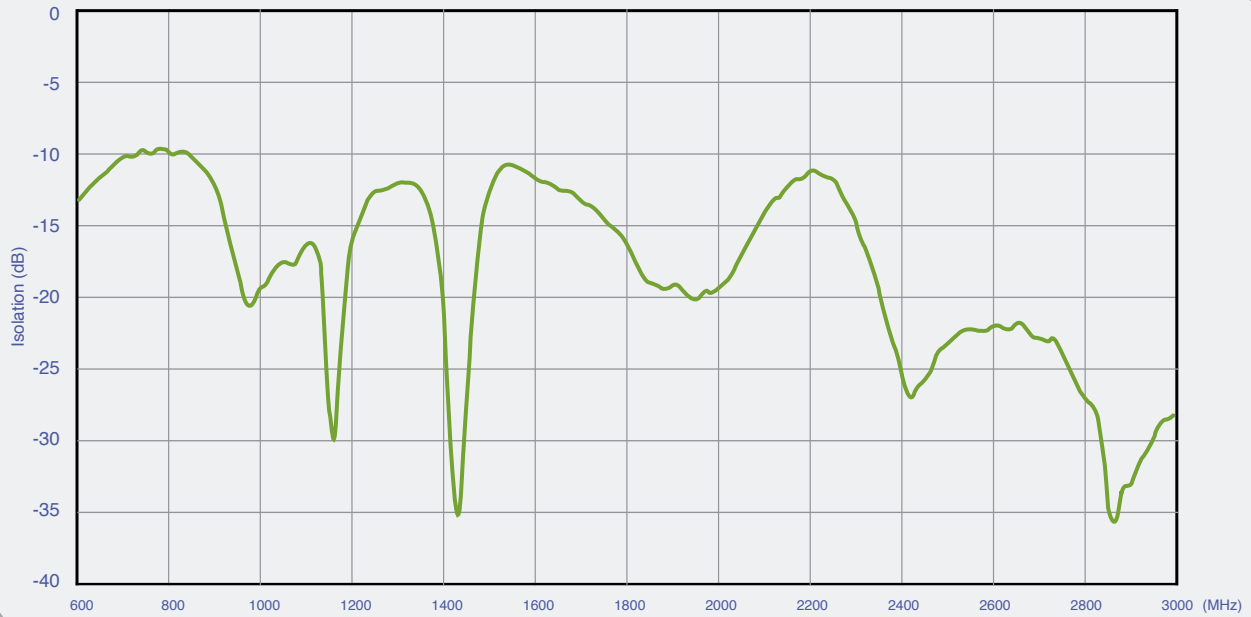

#### 3.4. Envelope Correlation Coefficient

Figure 6. ECC of FXUB70 in between Port 1 and Port 2.

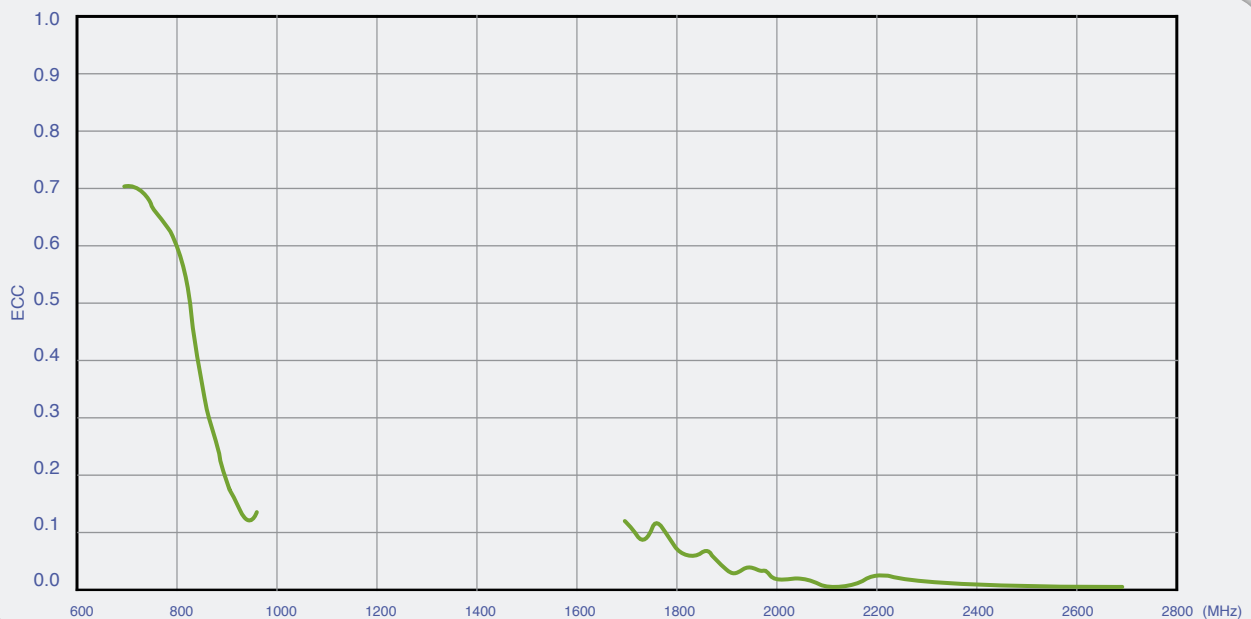

### 3. Antenna Parameters

#### 3.5. Peak Gain

Figure 7. Peak Gain of FXUB70 Port 1

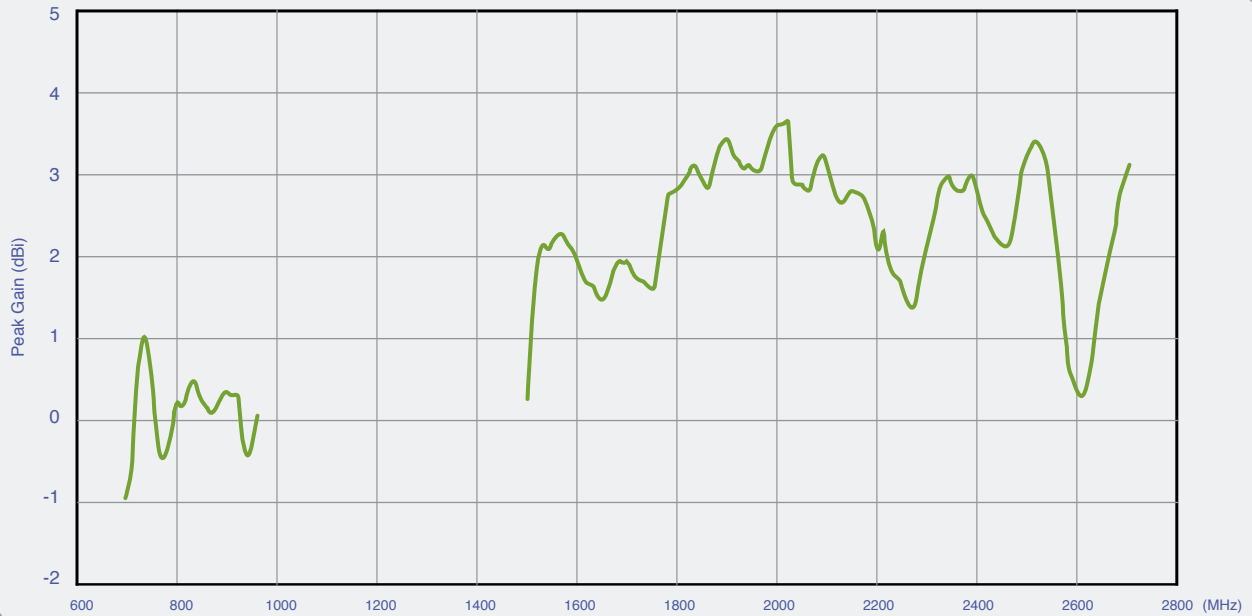
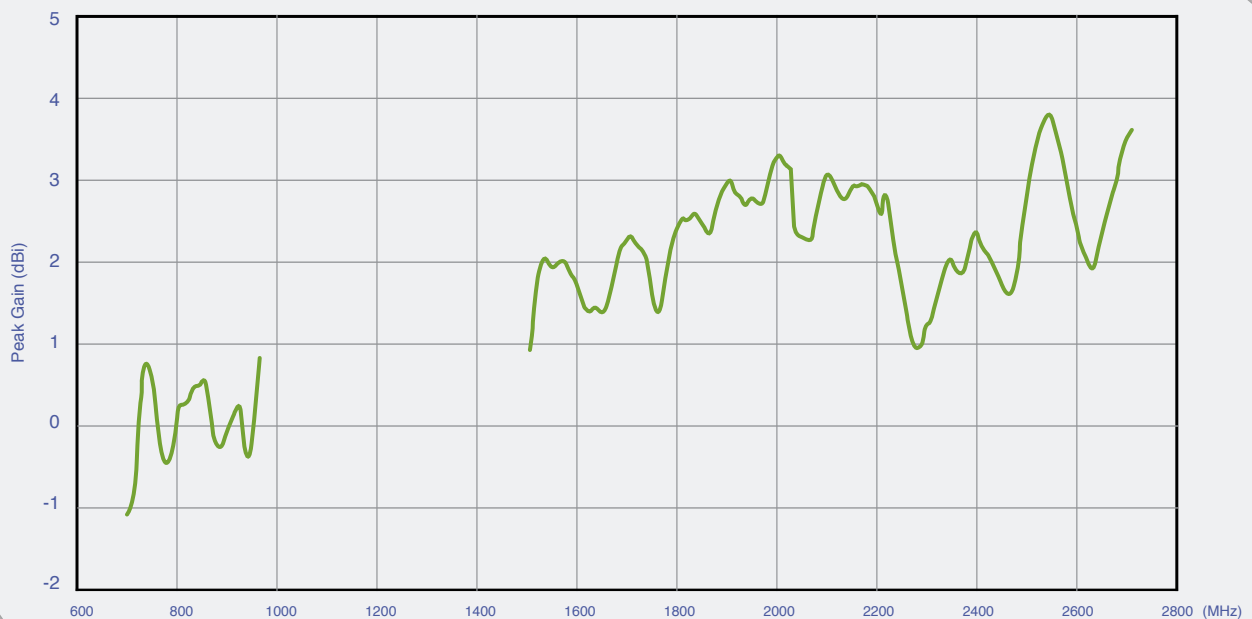

Figure 8. Peak Gain of FXUB70 Port 2



### 3. Antenna Parameters

#### 3.6 Efficiency

Figure 9. Efficiency of FXUB70 Port 1

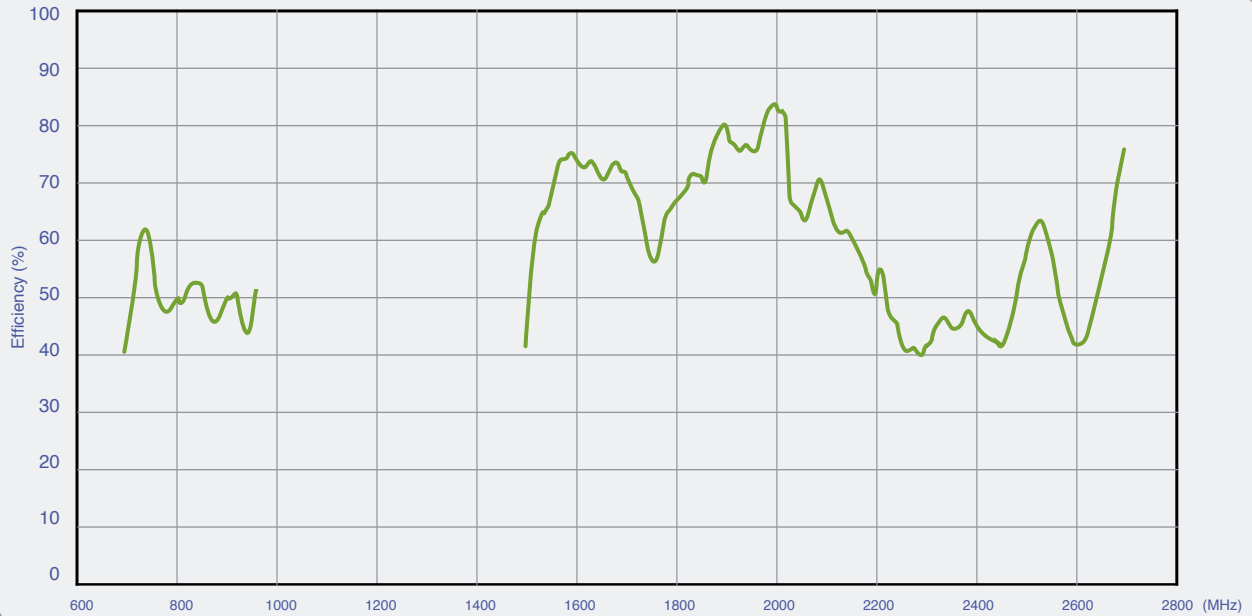
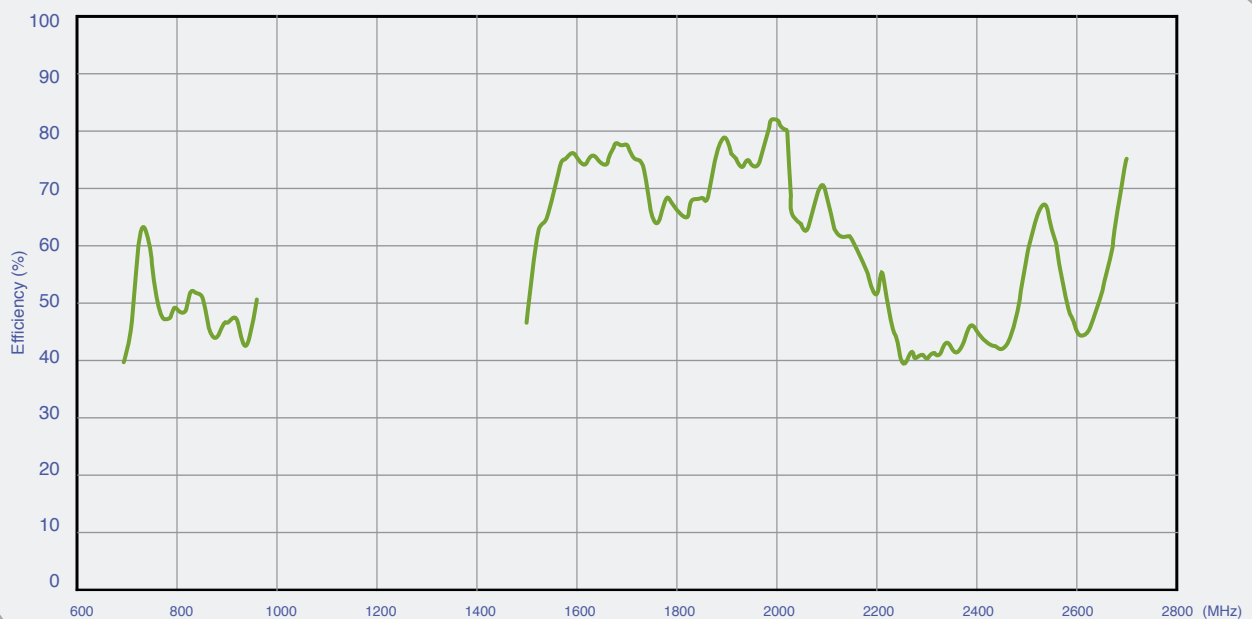

Figure 10. Efficiency of FXUB70 Port 2





### 3. Antenna Parameters

#### 3.7 Average Gain

Figure 11. Average Gain of FXUB70 Port 1

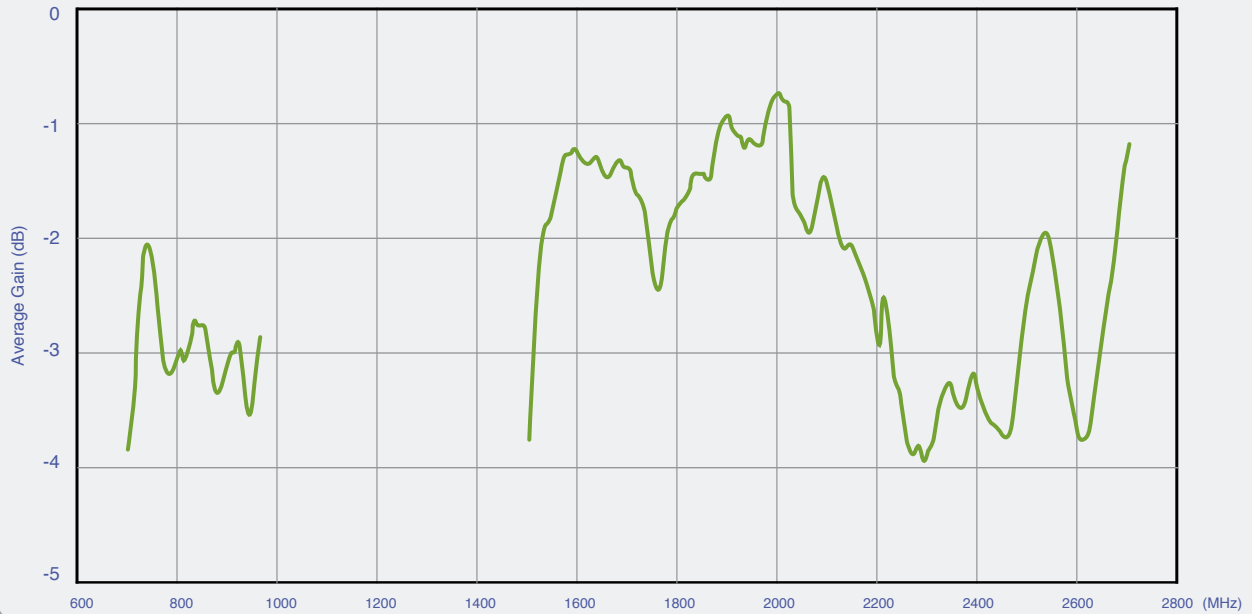
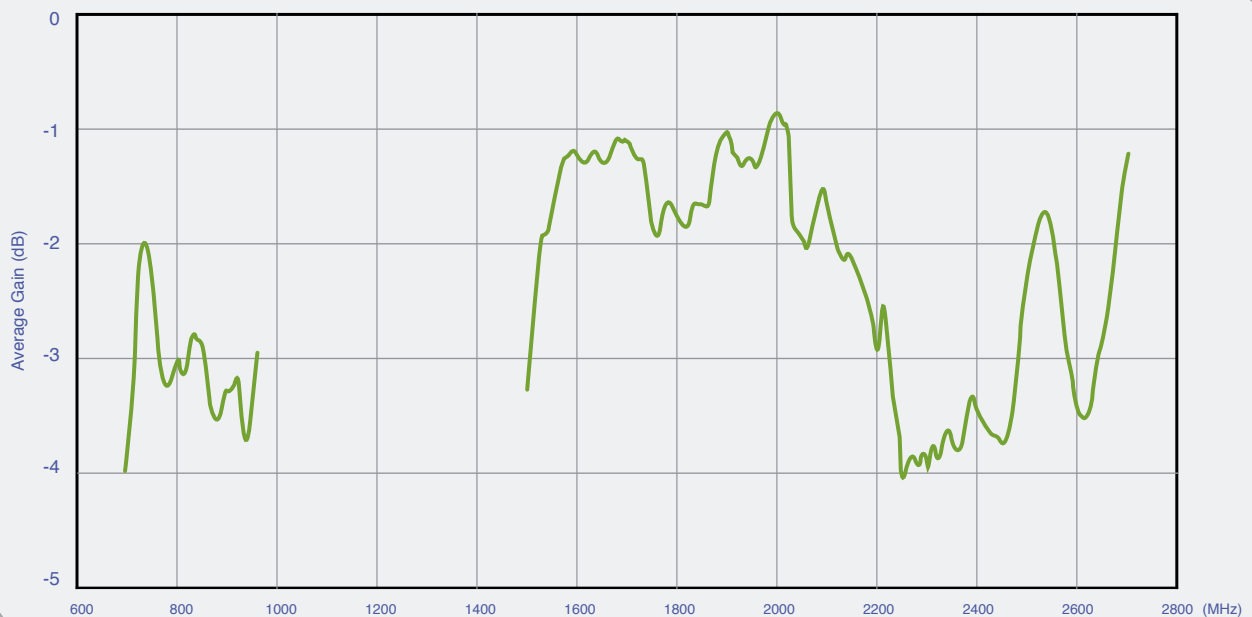

Figure 12. Average Gain of FXUB70 Port 2



### 3.8. Radiation Pattern

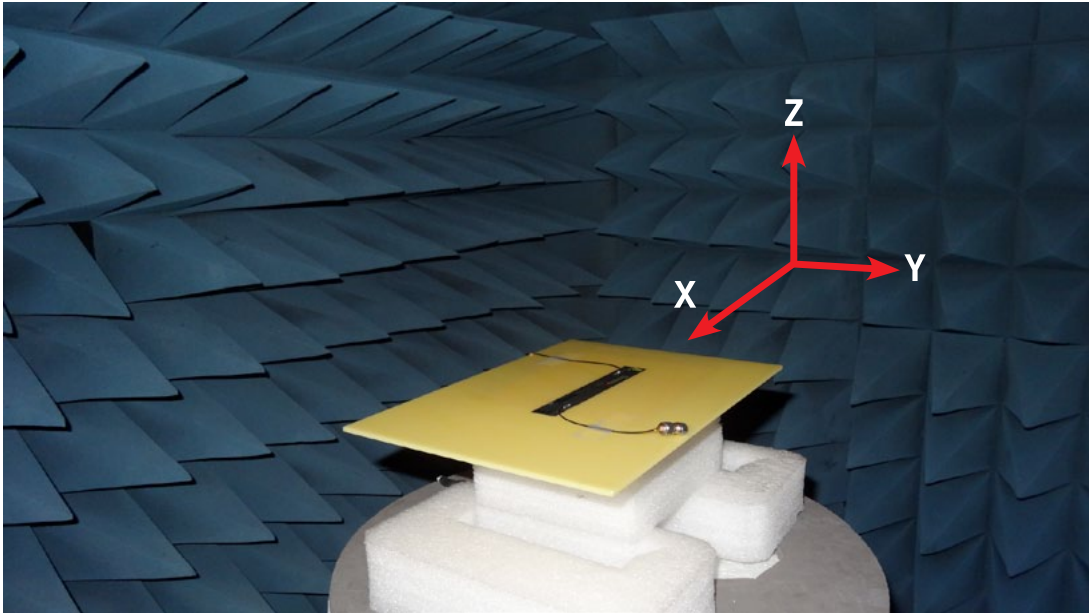

Figure 13. Radiation Pattern Reference of FXUB70

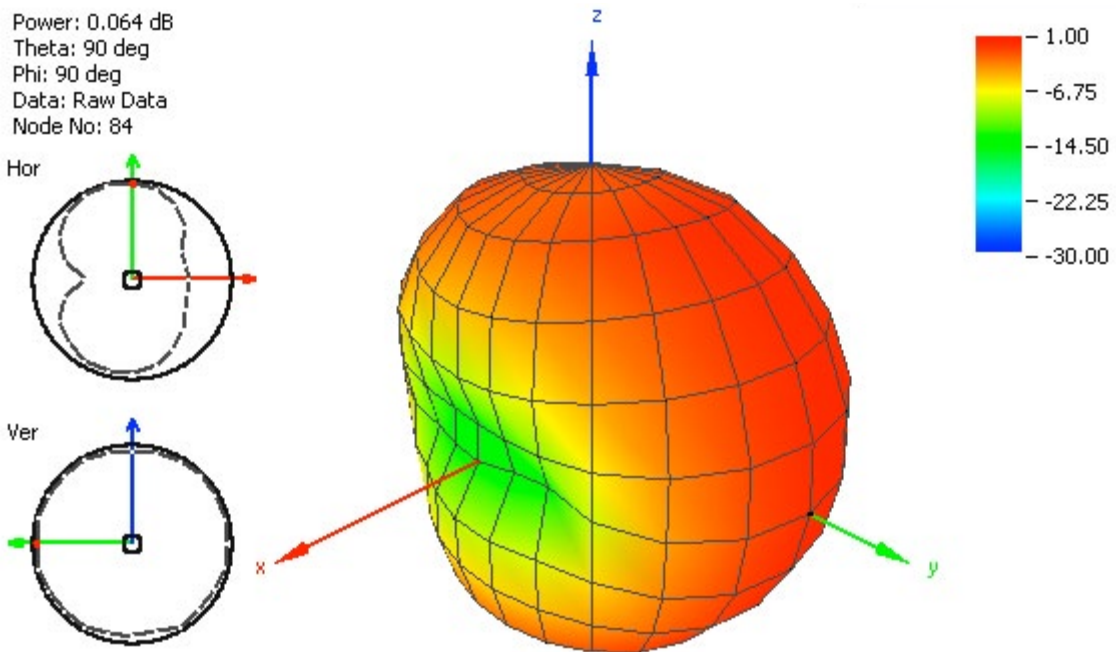

Figure 14. Radiation Pattern at 750 MHz of FXUB70 Port 1

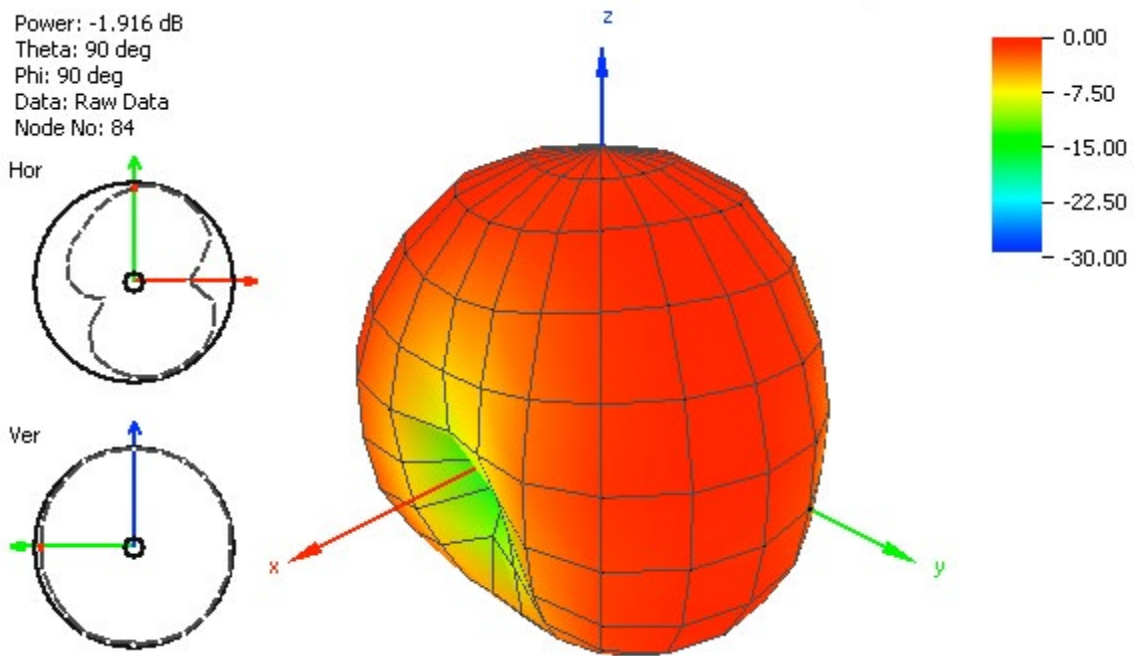

Figure 15. Radiation Pattern at 750 MHz of FXUB70 Port 2

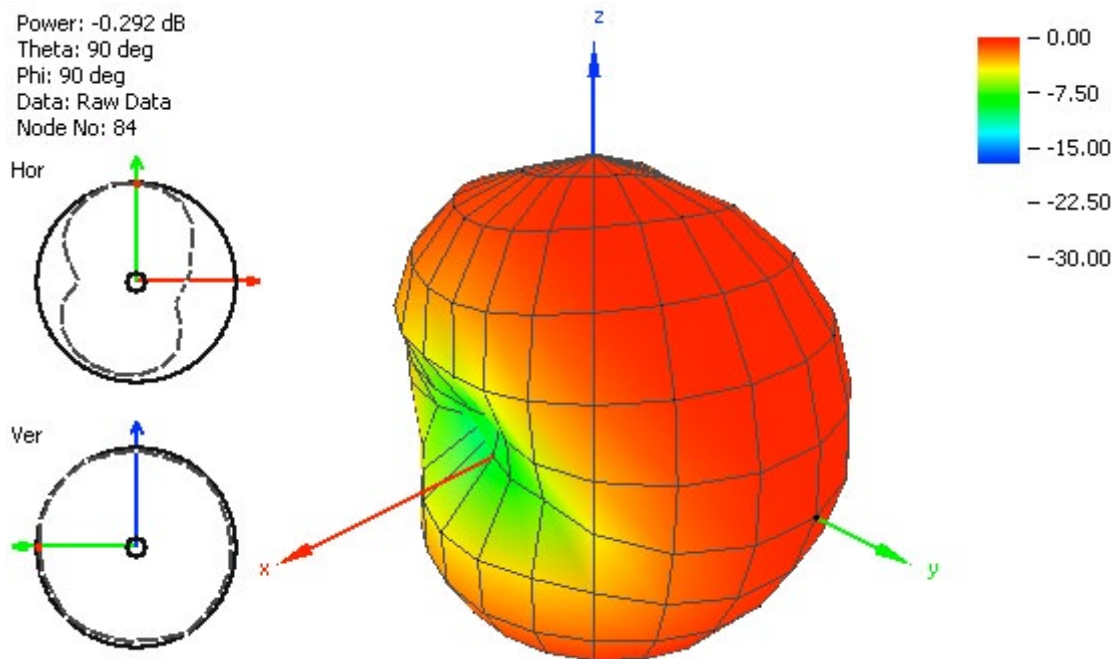

Figure 16. Radiation Pattern at 850 MHz of FXUB70 Port 1.

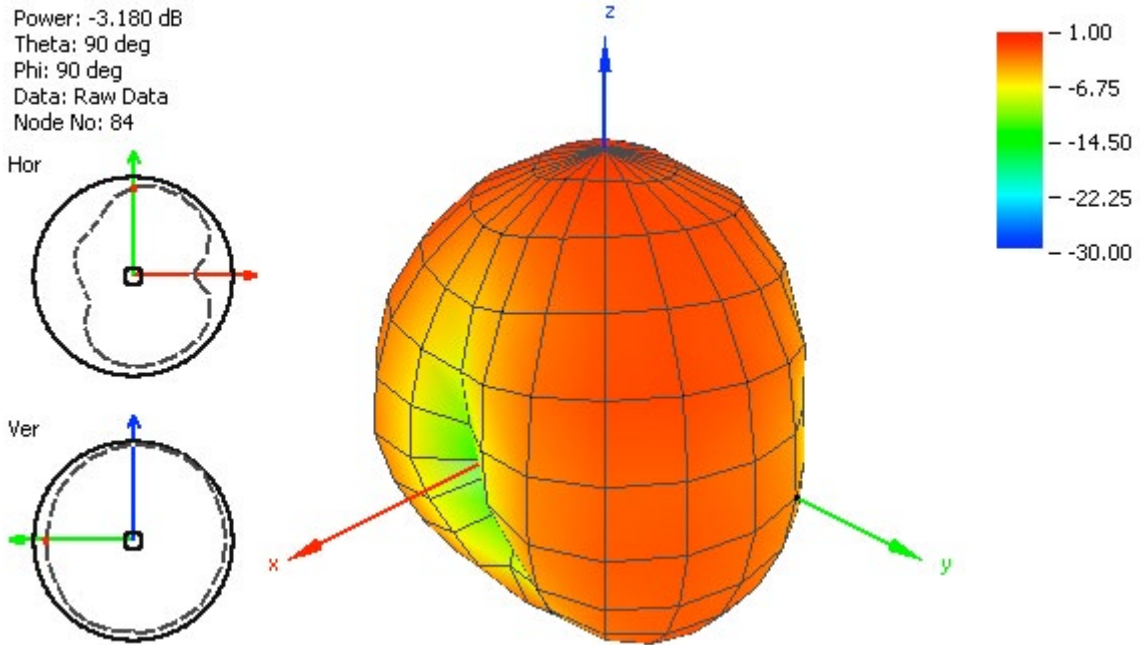

Figure 17. Radiation Pattern at 850 MHz of FXUB70 Port 2

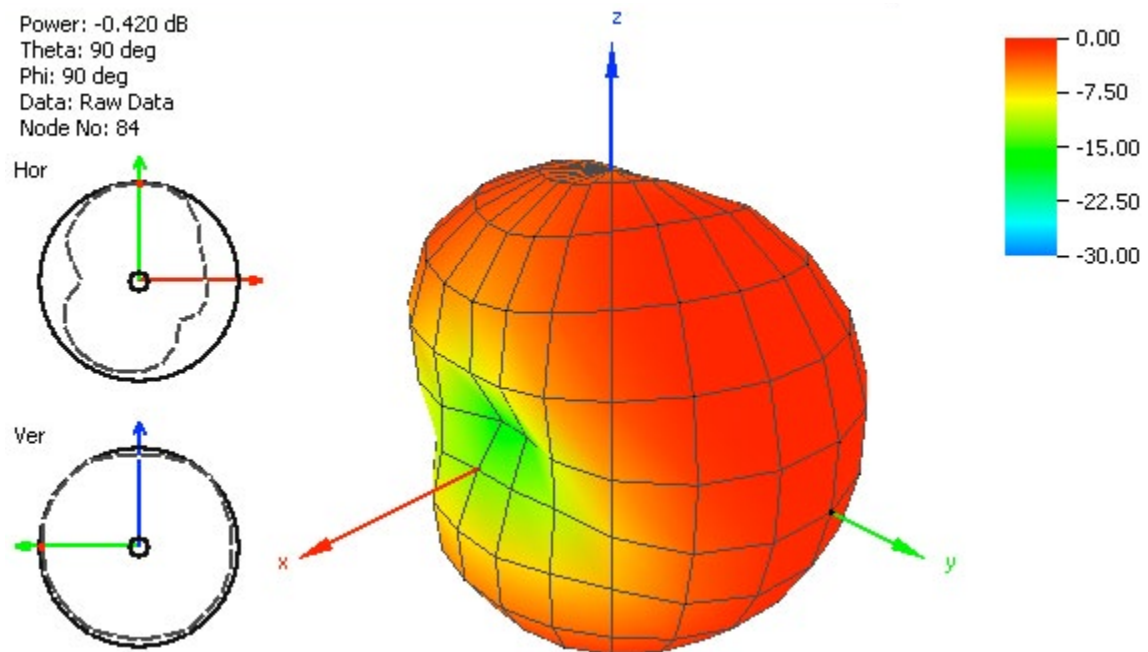

Figure 18. Radiation Pattern at 925 MHz of FXUB70 Port 1

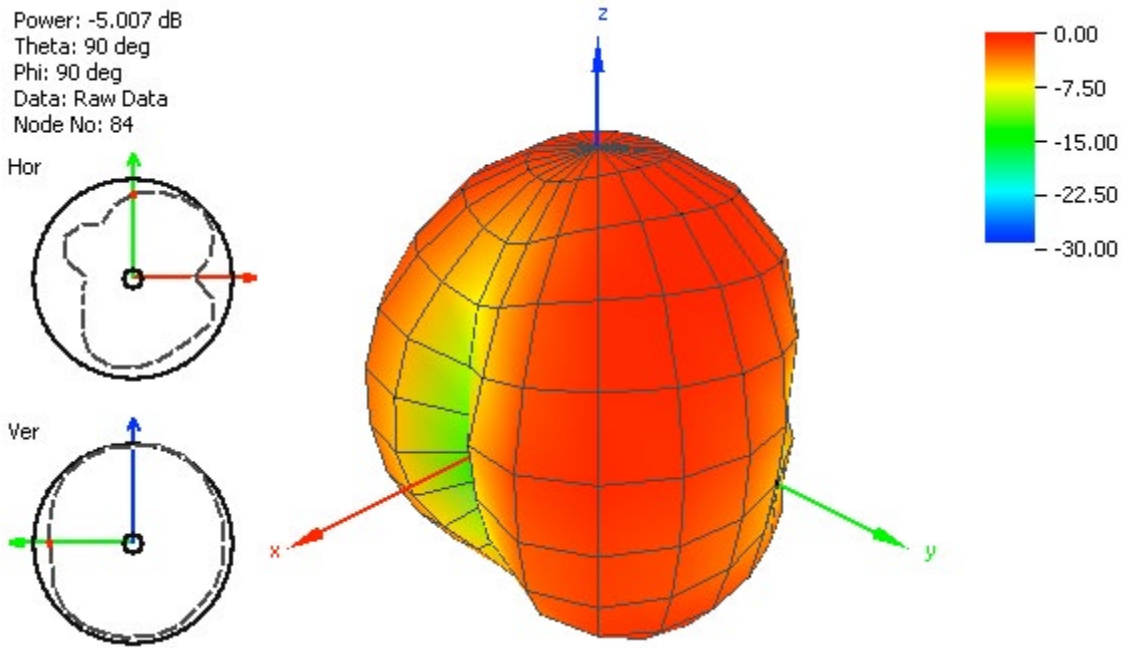

Figure 19. Radiation Pattern at 925 MHz of FXUB70 Port 2

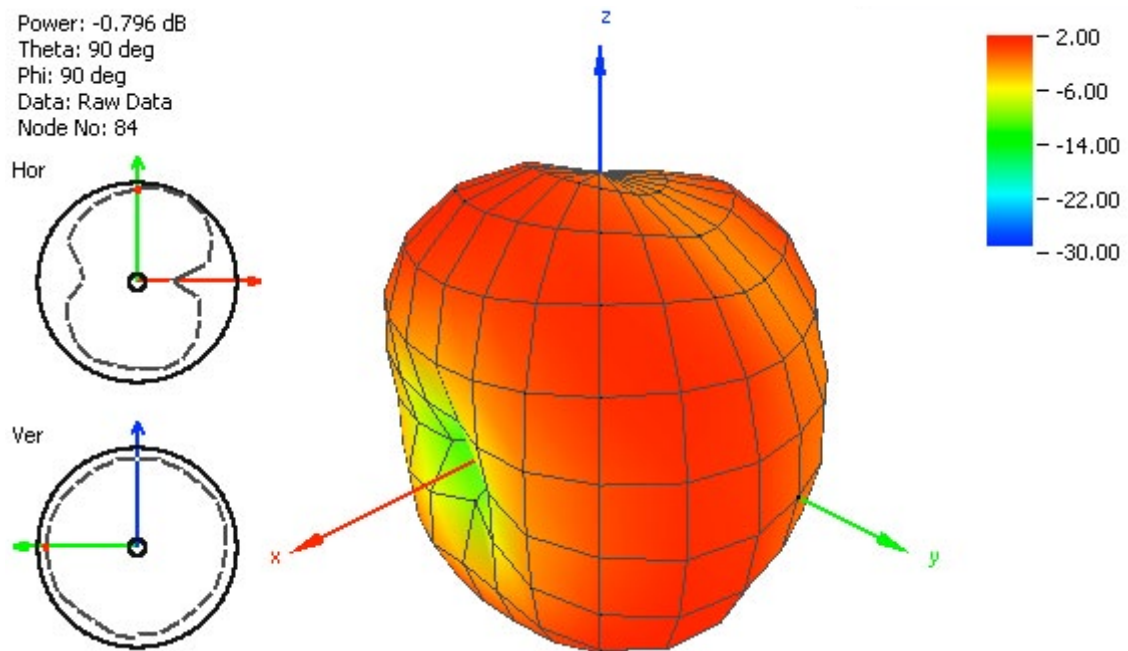

Figure 20. Radiation Pattern at 1575 MHz of FXUB70 Port1



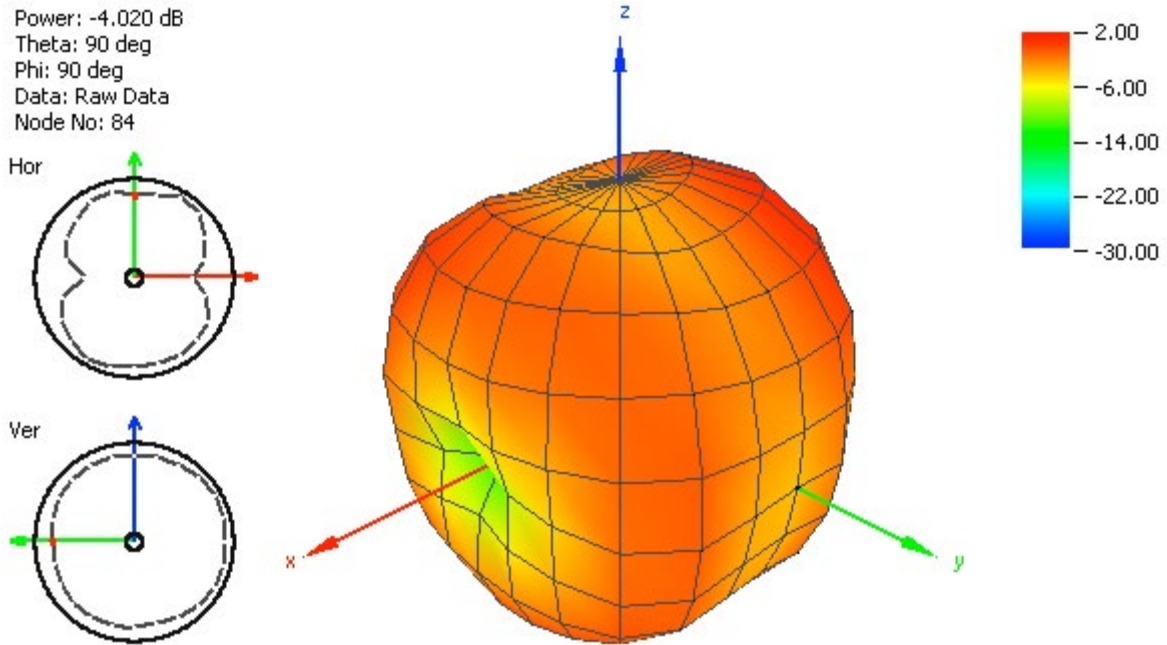

Figure 21. Radiation Pattern at 1575 MHz of FXUB70 Port 2

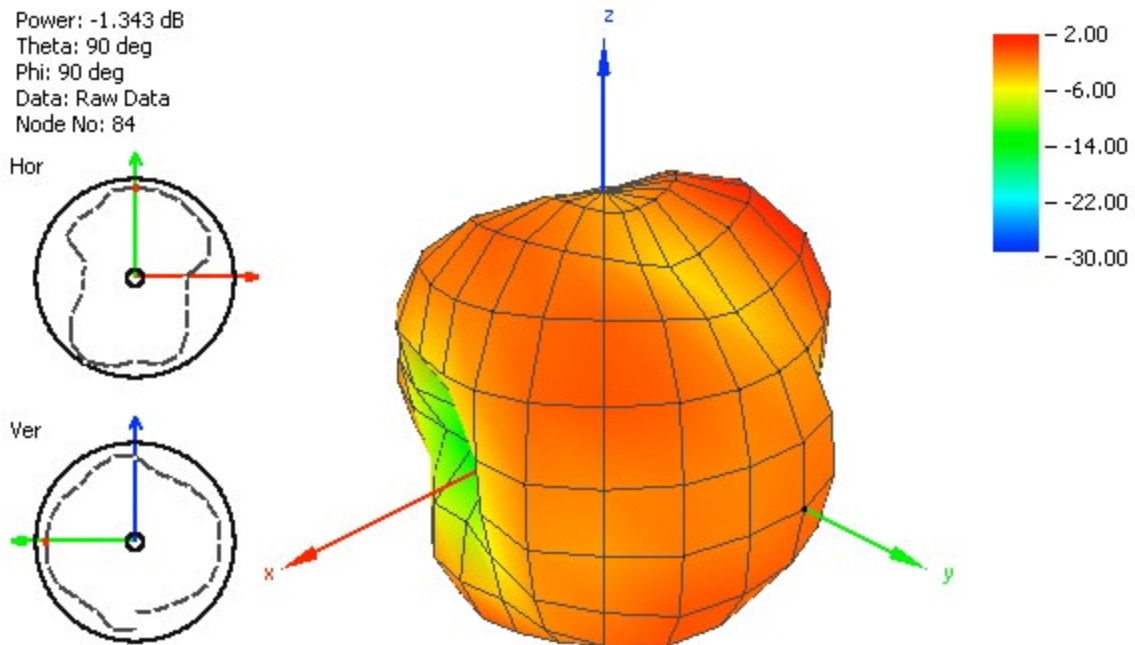

Figure 22. Radiation Pattern at 1750 MHz of FXUB70 Port 1

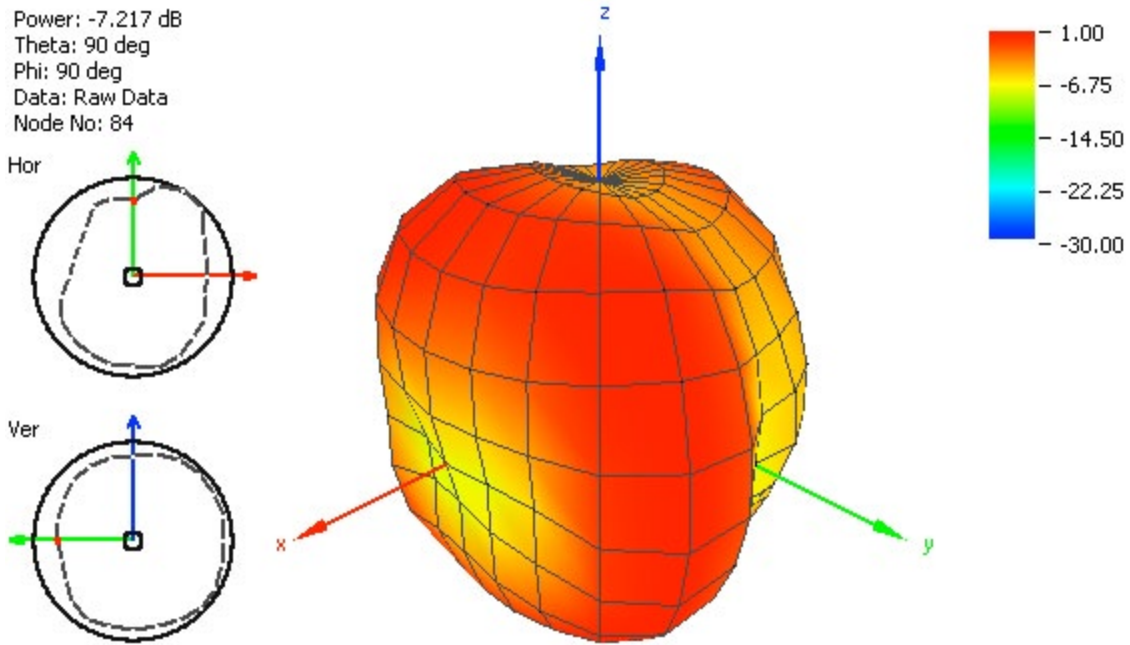

Figure 23. Radiation Pattern at 1750 MHz of FXUB70 Port 2

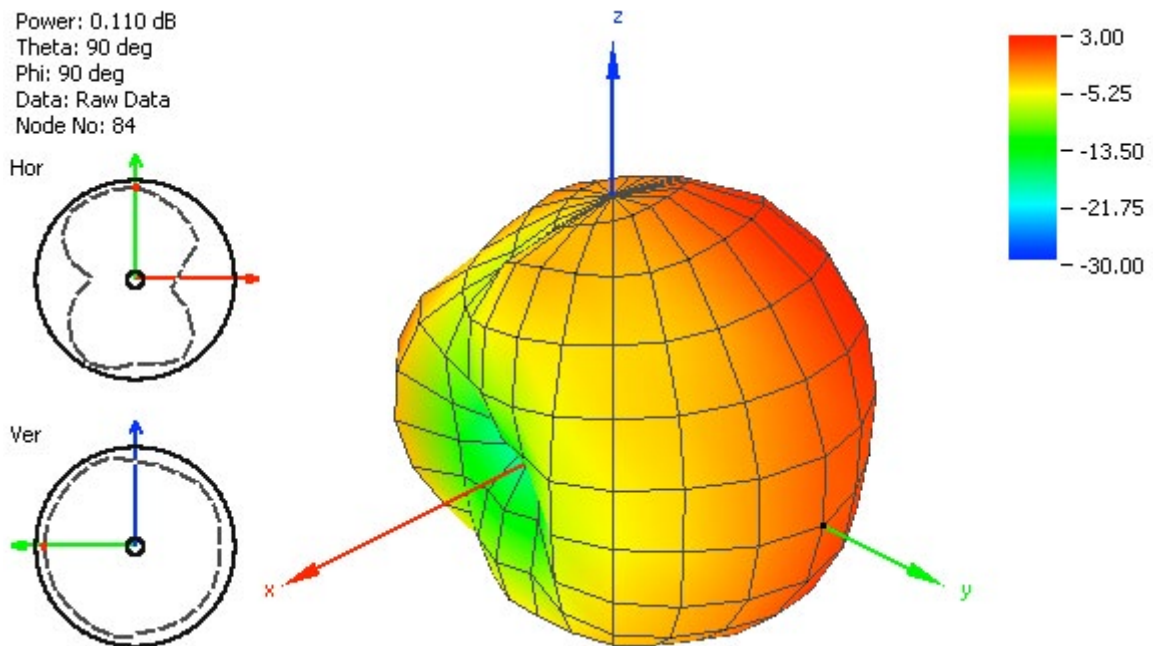

Figure 24. Radiation Pattern at 1850 MHz of FXUB70 Port 1.

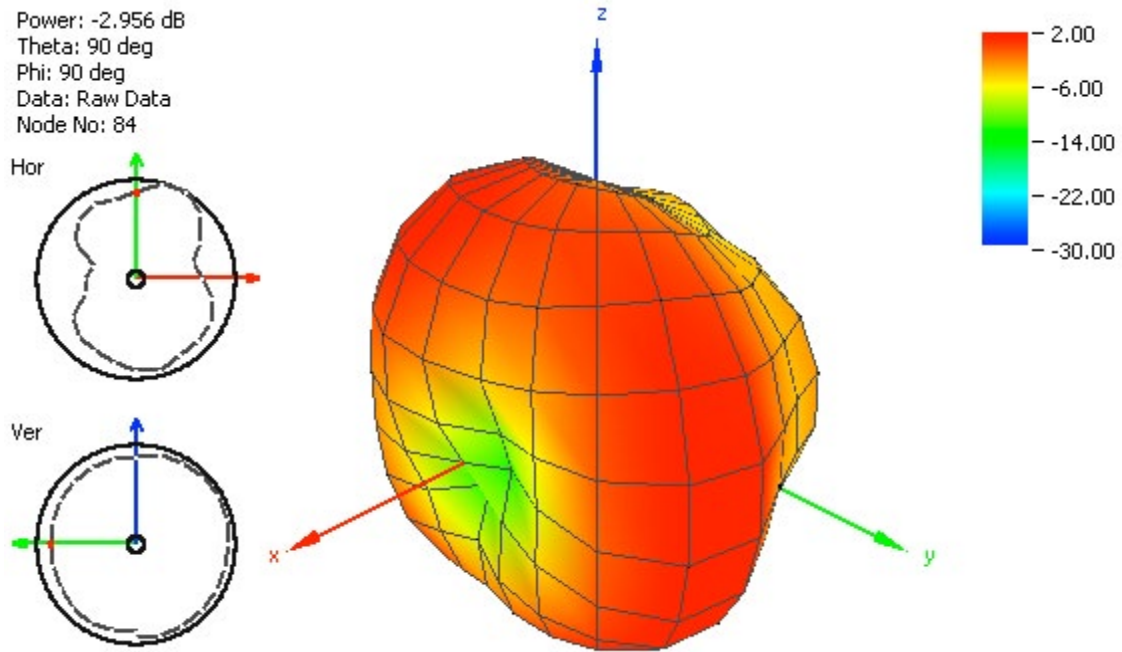

Figure 25. Radiation Pattern at 1850 MHz of FXUB70 Port 2

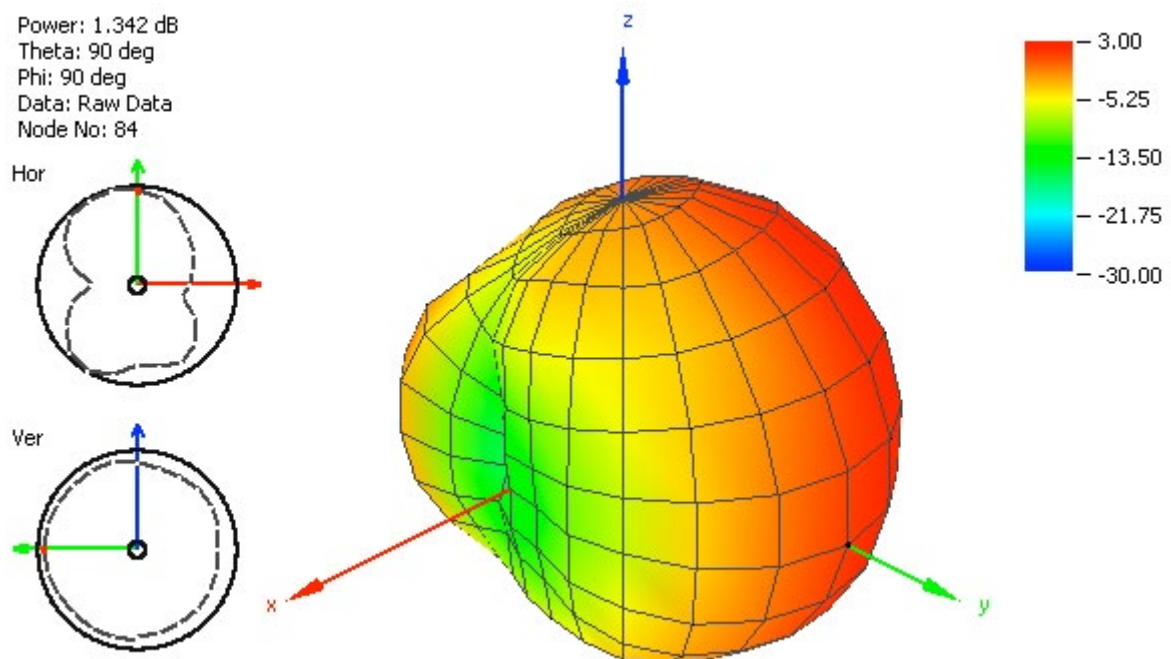

Figure 26. Radiation Pattern at 1950 MHz of FXUB70 Port 1



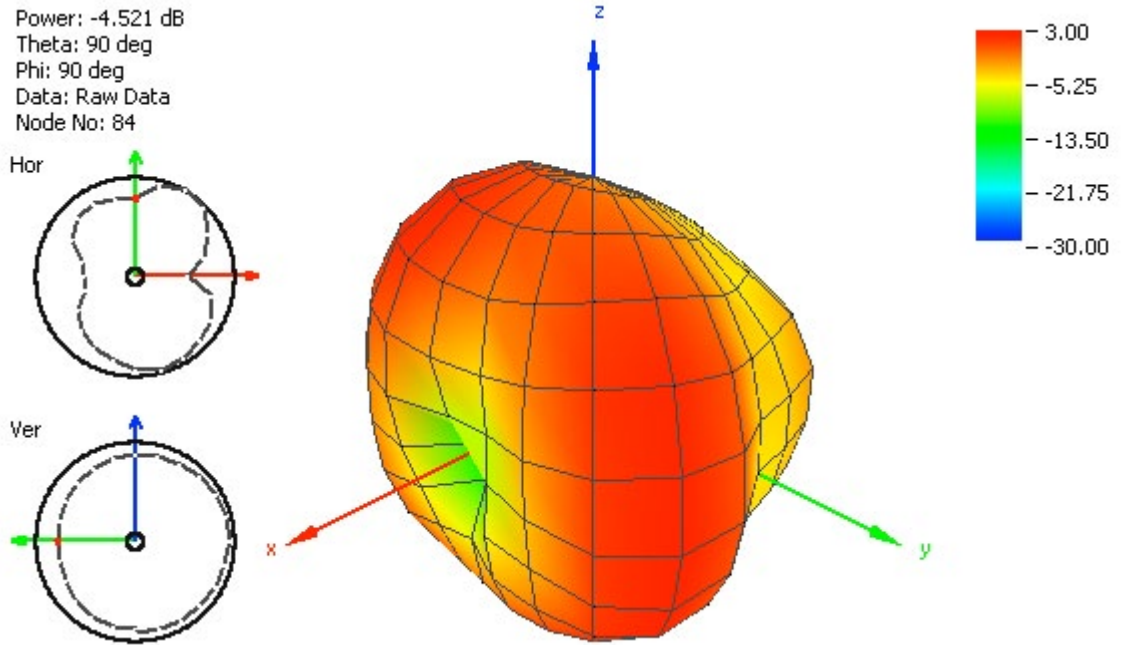

Figure 27. Radiation Pattern at 1950 MHz of FXUB70 Port 2.

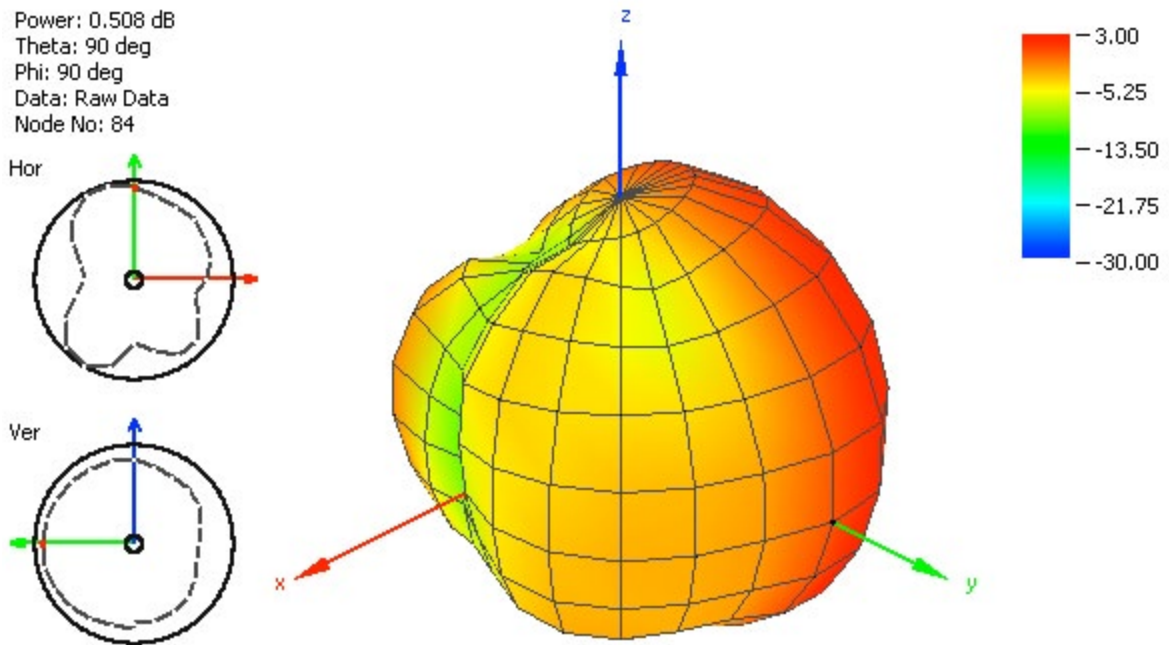

Figure 28. Radiation Pattern at 2100 MHz of FXUB70 Port 1

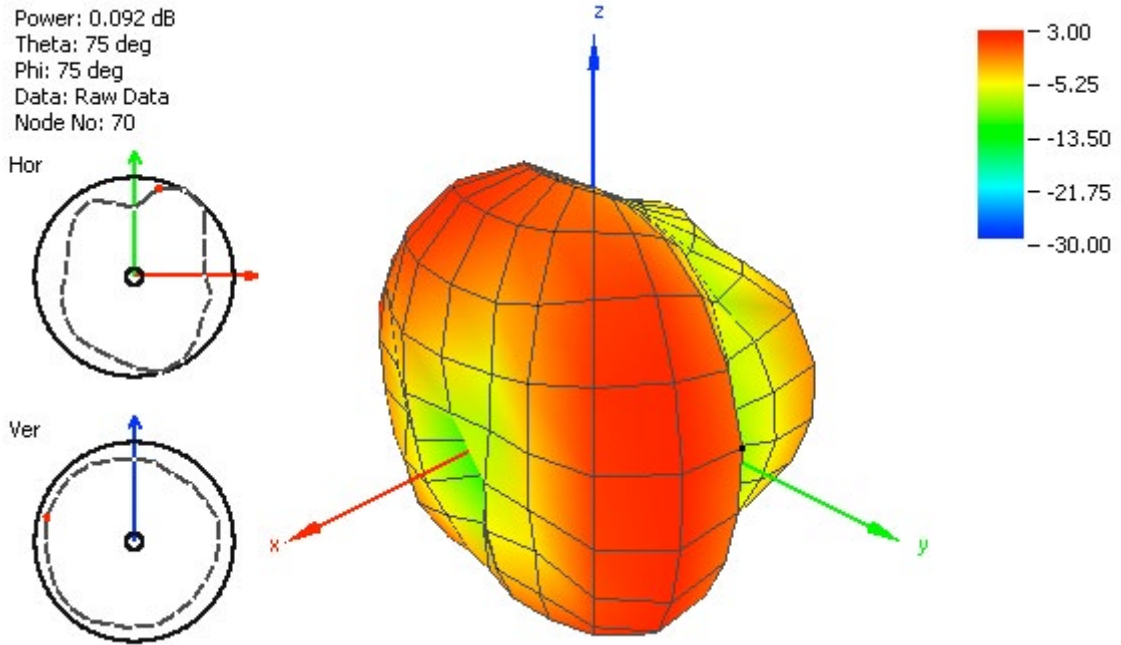

Figure 29. Radiation Pattern at 2100 MHz of FXUB70 Port 2

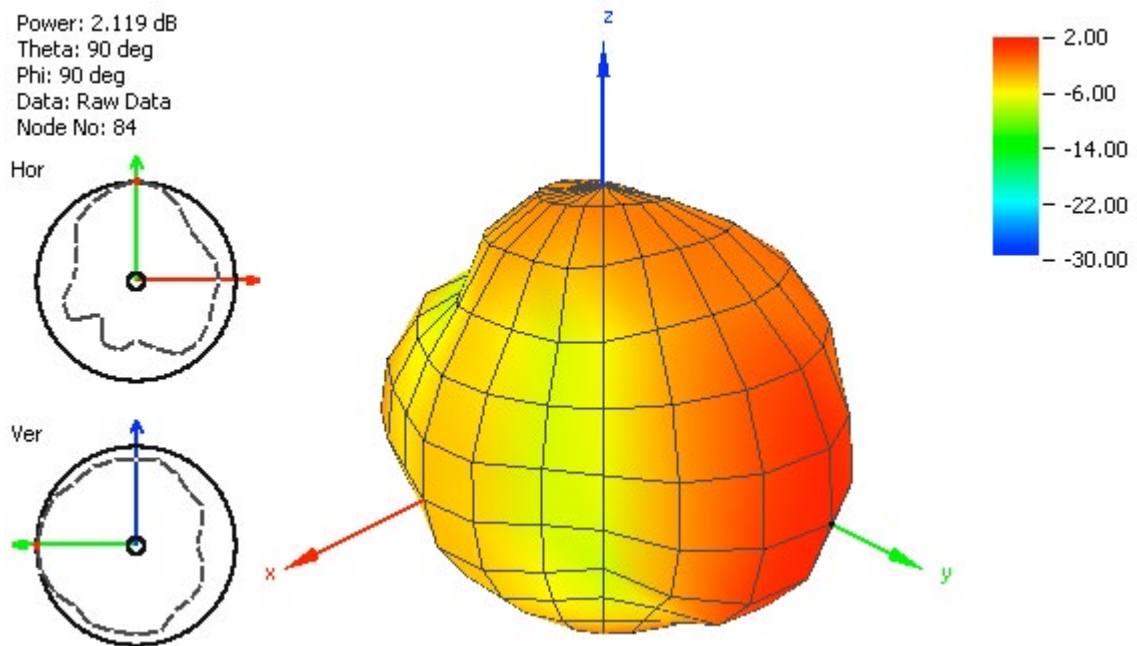

Figure 30. Radiation Pattern at 2450 MHz of FXUB70 Port 1

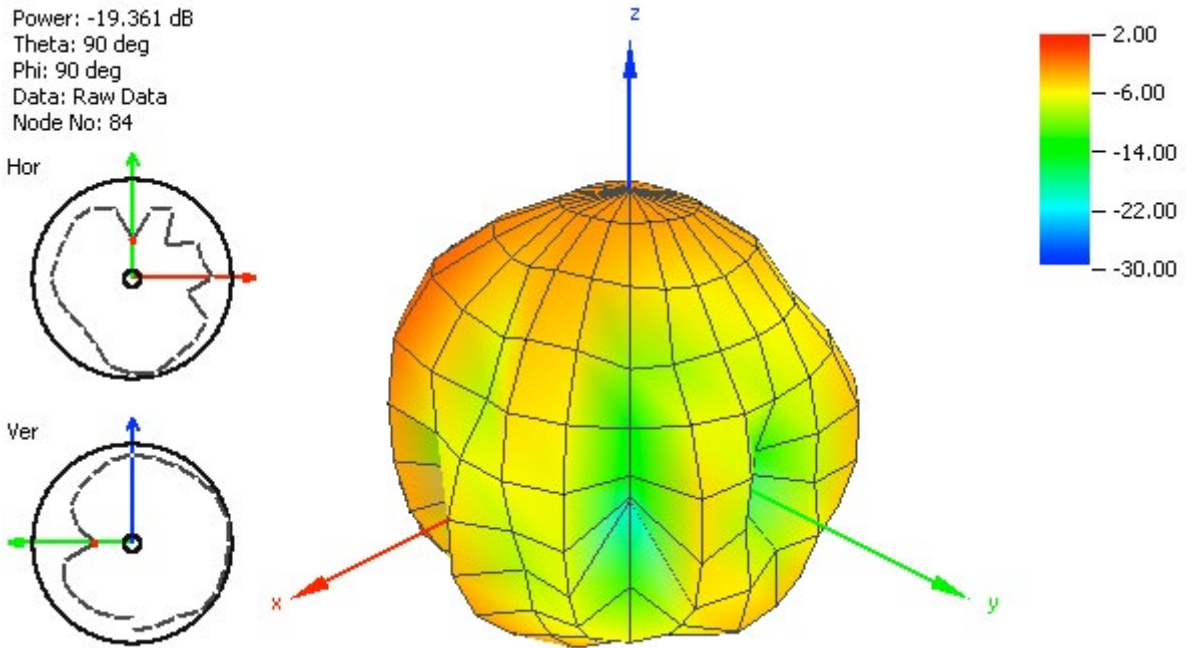

Figure 31. Radiation Pattern at 2450 MHz of FXUB70 Port 2.

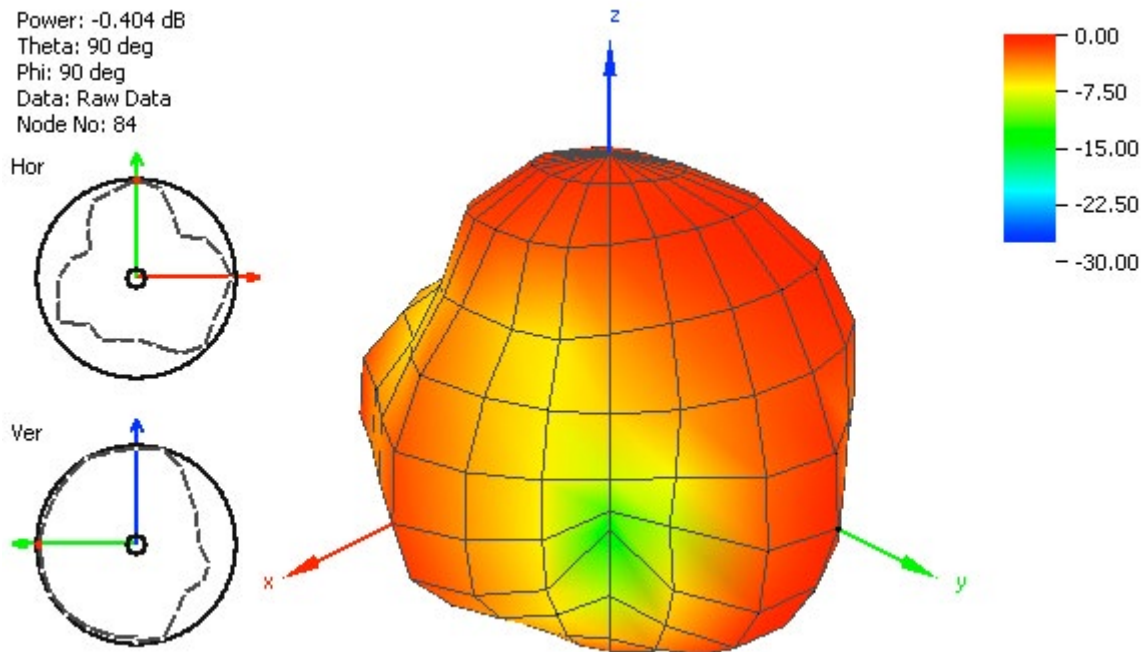

Figure 32. Radiation Pattern at 2600 MHz of FXUB70 Port 1

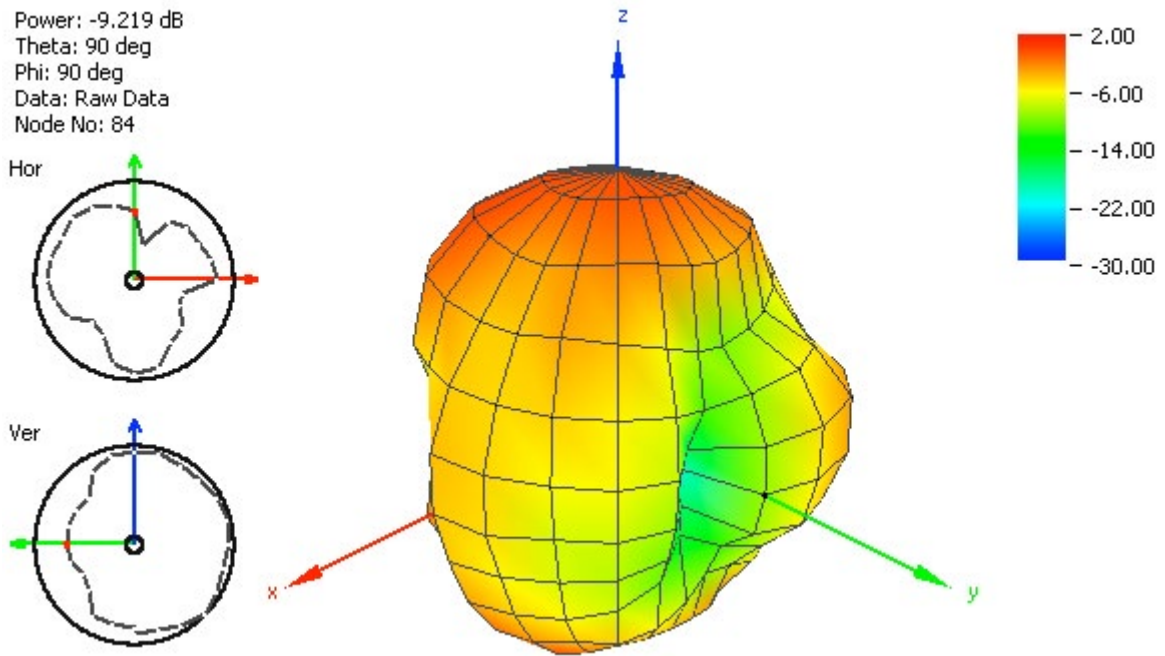

Figure 33. Radiation Pattern at 2600 MHz of FXUB70 Port 2.

## 4. Mechanical Drawing

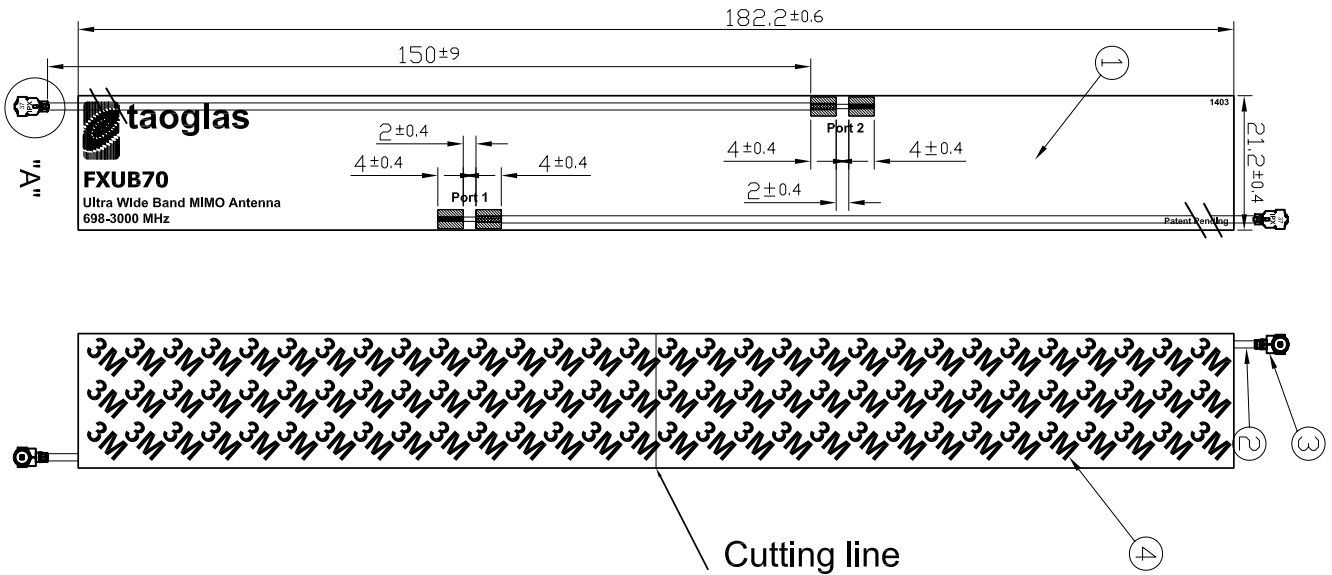
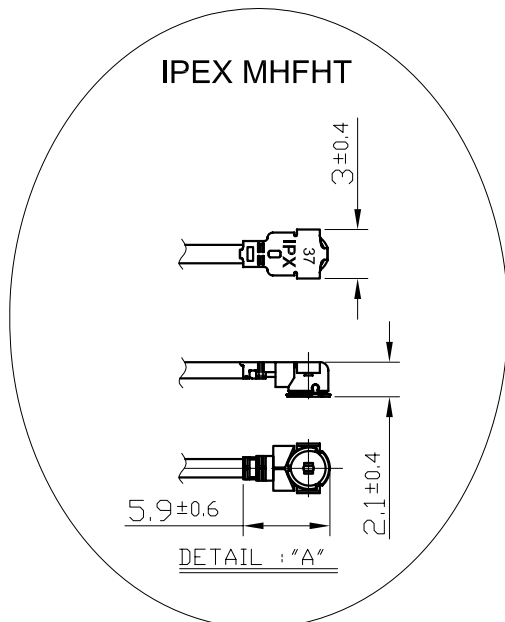

Figure 34. Mechanical drawing of FXUB70 UWB Antenna.



	Name	Material	Finish	QTY
1	FXUB70 PCB	FPCB 0.15t	Black	1
2	1.37 Mini-Coaxial Cable	FEP	Black	2
3	IPEX MHFHT	Brass	Gold	2
4	Double-Sided Adhesive	3M 467	Liner	1

Taoglas makes no warranties based on the accuracy or completeness of the contents of this document and reserves the right to make changes to specifications and product descriptions at any time without

notice. Taoglas reserves all rights to this document and the information contained herein.

Reproduction, use or disclosure to third parties without express permission is strictly prohibited.

Copyright © Taoglas Ltd.