

ADMIRAL CLASS - INTERNATIONAL LEAD WIRES, POWER TRANSFORMER

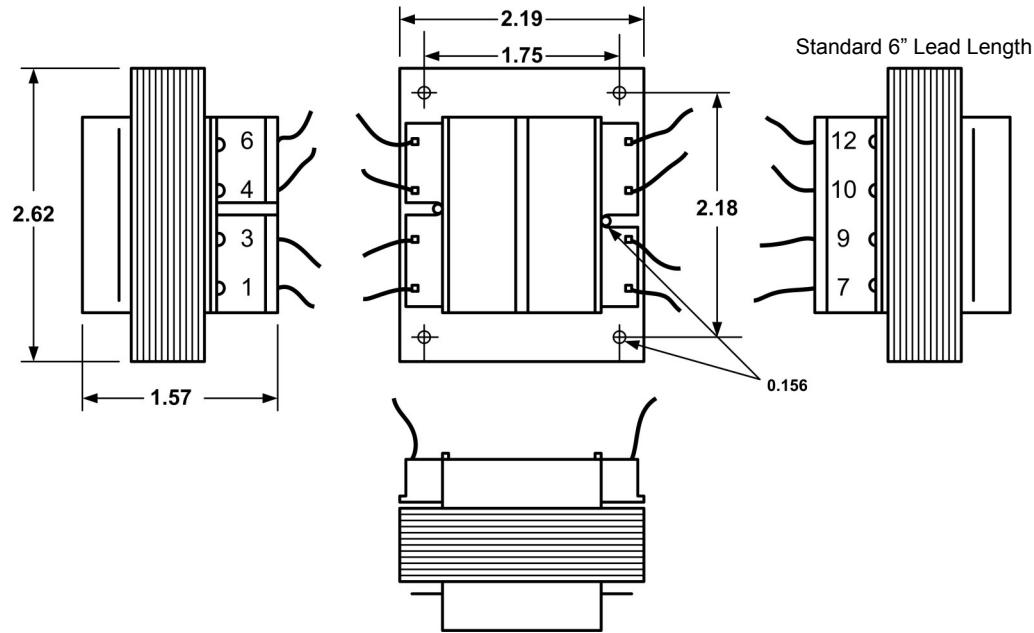

1. Electrical Specifications

- A. Maximum Power: 30VA
- B. Input Voltage and Frequency: 115V, 115/230V, 230V 50/60Hz
- C. Voltage Regulation: ___% TYP @ full load to no load
- D. Temperature Rise: ___°C TYP
- E. Insulation Resistance: _____
- F. Hi-Pot: 4000Vrms 1 minute @ Pri to Sec
 _____Vrms 1 minute @ Pri to Core
 _____Vrms 1 minute @ Sec to Core

- 2. Marking: Ensign Corp, part number (see table), date code
- 3. Safety:

UL/cUL 5085-2 Recognized (File 47299)
 UL 60950 Recognized (File E144070)
 VDE 0805 Licensed (File 19019-3336-9002/A1C)
 UL 1446 Recognized Insulation System (File 95662)

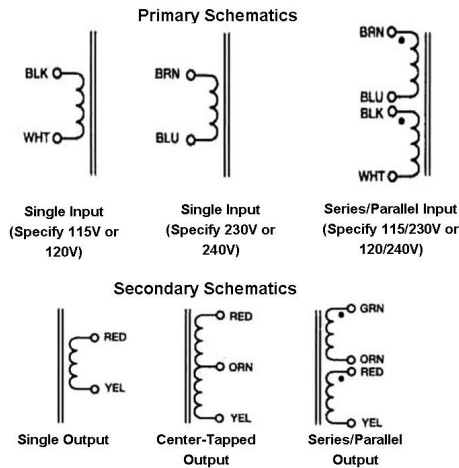

Part Number			Series Connection	Parallel Connection
115V	115/230V	230V		
IL030-1-010X	IL030-2-010X	IL030-3-010X	10VCT @ 3.0A	5V @ 6.0A
IL030-1-012X	IL030-2-012X	IL030-3-012X	12.6VCT @ 2.4A	6.3V @ 4.8A
IL030-1-016X	IL030-2-016X	IL030-3-016X	16VCT @ 1.9A	8V @ 3.8A
IL030-1-020X	IL030-2-020X	IL030-3-020X	20VCT @ 1.5A	10V @ 3.0A
IL030-1-024X	IL030-2-024X	IL030-3-024X	24VCT @ 1.25A	12V @ 2.50A
IL030-1-028X	IL030-2-028X	IL030-3-028X	28VCT @ 1.06A	14V @ 2.12A
IL030-1-036X	IL030-2-036X	IL030-3-036X	36VCT @ 0.82A	18V @ 1.64A

<p>ENSIGN THE FLAGSHIP OF CUSTOM MAGNETICS SINCE 1939</p>	<p>POWER TRANSFORMER ADMIRAL CLASS</p>		<p>IL030-1-XXXX IL030-2-XXXX IL030-3-XXXX</p>	
	<p>CONTENTS OF THIS DRAWING ARE SUBJECT TO CHANGE WITHOUT PRIOR NOTICE</p>		<p>Ensign Corporation 201 ENSIGN RD., BELLEVUE, IA 52031</p>	<p>Dim: Inches</p>
<p>PROPRIETARY NOTICE: THIS DRAWING PRINT OR DOCUMENT AND SUBJECT MATTER DISCLOSED HEREIN ARE PROPRIETARY ITEMS TO WHICH ENSIGN RETAINS THE EXCLUSIVE RIGHT OF DISSEMINATION, MANUFACTURE AND SALE. THIS DRAWING, PRINT OR DOCUMENT IS SUBMITTED IN CONFIDENCE FOR CONSIDERATION BY THE RECIPIENT ALONE UNLESS PERMISSION FOR FURTHER DISCLOSURE IS EXPRESSLY GRANTED IN WRITING</p>				