

A Unit of Teledyne Electronics and Communications

ESTABLISHED RELIABILITY TO-5 RELAYS SPDT

SERIES 411

ESTABLISHED RELIABILITY

SERIES DESIGNATION	RELAY TYPE
411	SPDT basic relay
411D	SPDT relay with internal diode for coil suppression
411DD	SPDT relay with internal diodes for coil transient suppression and polarity reversal protection
411T	SPDT relay with internal transistor driver and coil transient suppression diode

INTERNAL CONSTRUCTION

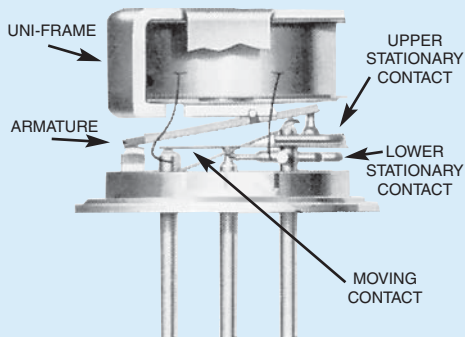

DESCRIPTION

The TO-5 relay, originally conceived and developed by Teledyne, has become one of the industry standards for low-level switching from dry circuit to 1 ampere. Designed specifically for high-density PC board mounting, its small size and low coil power dissipation make the 411 relay one of the most versatile ultraminiature relays available.

The following unique construction features and manufacturing techniques provide excellent resistance to environmental extremes and overall high reliability.

- All welded construction.
- Unique uni-frame design, providing high magnetic efficiency and mechanical rigidity.
- High force/mass ratios for resistance to shock and vibration.
- Advanced cleaning techniques provide maximum assurance of internal cleanliness.
- Precious metal alloy contact material with gold plating assures excellent high current and dry circuit switching capabilities.

The Series 411D and 411DD relays have internal discrete silicon diodes for coil suppression and polarity reversal protection. The hybrid 411T relay features an internal silicon suppression diode and transistor driver. This hybrid package reduces required PC board floor space by reducing the number of external components needed to drive the relay.

By virtue of its inherently low intercontact capacitance and contact circuit losses, the 411 relay has proven to be an excellent ultraminiature RF switch for frequency ranges well into the UHF spectrum. A typical RF application for the TO-5 relay is in handheld radio transceivers, wherein the combined features of good RF performance, small size, low coil power dissipation and high reliability make it a preferred method of T-R switching (see Figure 1).

ENVIRONMENTAL AND PHYSICAL SPECIFICATIONS

Temperature (Ambient)	-65°C to +125°C
Vibration (General Note 1)	30 g's to 3000 Hz
Shock (General Note 1)	75 g's, 6 msec, half-sine
Acceleration	50 g's
Enclosure	Hermetically sealed
Weight	0.089 oz. (2.52g) max.

SERIES 411
GENERAL ELECTRICAL SPECIFICATIONS (-65°C to +125°C unless otherwise noted) (Notes 2 & 3)

Contact Arrangement	1 Form C (SPDT)	
Rated Duty	Continuous	
Contact Resistance	0.1 ohm max. before life; 0.2 ohm max. after life at 1A/28Vdc (measured 1/8" from header)	
Contact Load Ratings (DC) (See Fig. 2 for other DC resistive voltage/current ratings)	Resistive: 1 Amp/28Vdc Inductive: 200 mA/28Vdc (320 mH) Lamp: 100 mA/28Vdc Low Level: 10 to 50 µA/10 to 50mV	
Contact Load Ratings (AC)	Resistive: 250 mA/115Vac, 60 and 400 Hz (Case not grounded) 100 mA/115Vac, 60 and 400 Hz (Case grounded)	
Contact Life Ratings	10,000,000 cycles (typical) at low level 1,000,000 cycles (typical) at 0.5A/28Vdc resistive 100,000 cycles min. at all other loads specified above	
Contact Overload Rating	2A/28Vdc Resistive (100 cycles min.)	
Contact Carry Rating	Contact factory	
Coil Operating Power	300 milliwatts typical at nominal rated voltage @ 25°C	
Operate Time	2.0 msec max. at nominal rated coil voltage	
Release Time	411 Series: 1.5 msec max. 411D, 411DD, 411T Series: 4.0 msec max.	
Contact Bounce	1.5 msec max.	
Intercontact Capacitance	0.4 pf typical	
Insulation Resistance	10,000 megohms min. between mutually isolated terminals	
Dielectric Strength	Atmospheric pressure: 500 Vrms/60Hz	70,000 ft.: 125 Vrms/60Hz
Negative Coil Transient (Vdc)	411D, 411DD, 411T	1.0 max
Diode P.I.V. (Vdc)	411D, 411DD, 411T	100 min.
411T Transistor Characteristics	Base Turn Off Voltage (Vdc)	0.3 min.
	Emitter-base breakdown Voltage (BV_{EBO}) (@25°C) (Vdc)	6.0 min.
	Collector-base breakdown Voltage (BV_{EBO}) (@25°C & I_c = 100 µA) (Vdc)	75 min.

DETAILED ELECTRICAL SPECIFICATIONS (-65°C to +125°C unless otherwise noted) (Note 3)

	BASE PART NUMBERS (See Note 10 for full P/N example)							
		411-5 411D-5 411DD-5 411T-5	411-6 411D-6 411DD-6 411T-6	411-9 411D-9 411DD-9 411T-9	411-12 411D-12 411DD-12 411T-12	411-18 411D-18 411DD-18 411T-18	411-26 411D-26 411DD-26 411T-26	
Coil Voltage (Vdc)	Nom.	5.0	6.0	9.0	12.0	18.0	26.5	
	Max.	6.0	8.0	12.0	16.0	24.0	32.0	
Coil Resistance (Ohms ±10% @25°C)	411, 411D, 411T (Note 4)	63	125	280	500	1130	2000	
	411DD (Note 4)	50	98	280	500	1130	2000	
Coil Current (mA_{dc} @25°C) (411DD Series)	Min.	72.7	46.3	25.9	20.0	13.6	11.5	
	Max.	100	62.4	33.7	25.6	17.2	14.4	
Coil Current (mA_{dc} @25°C) (411T Series)	Min.	66.6	42.0	28.0	20.9	13.8	11.5	
	Max.	89.6	55.5	38.1	28.1	18.8	15.5	
Pick-up Voltage (Vdc, Max.)	411, 411D	3.7	4.5	6.8	9.0	13.5	18.0	
	411DD	4.5	5.5	7.8	10.0	14.5	19.0	
	411T (Note 7)	3.9	5.2	7.8	10.0	14.5	19.0	
Base Current to Turn On (mA_{dc}, Max.) (411T Series) (Note 7)		2.38	1.60	1.07	0.80	0.53	0.40	
Drop-out Voltage (Vdc) (See Note 8 for 411T Series)	Min.	0.15	0.18	0.35	0.40	0.58	0.89	
	Max.	2.4	2.8	4.2	5.6	8.4	10.4	

PERFORMANCE CURVES (NOTE 2)

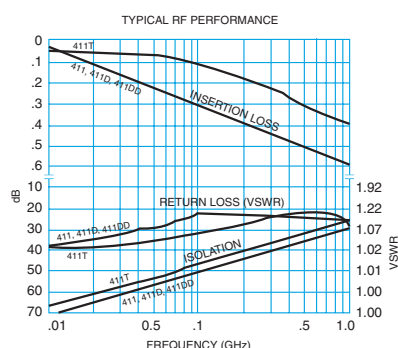

FIGURE 1

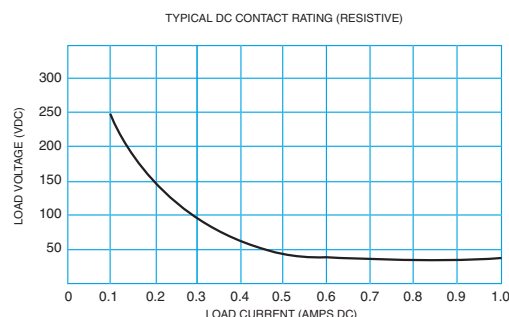

FIGURE 2

SERIES 411

OUTLINE DIMENSIONS

CASE DETAIL

LEAD & PIN LOCATIONS (Viewed from Terminals)

5 LEADS 8 LEADS

411, 411D, 411DD 411T

DIMENSIONS ARE SHOWN IN INCHES (MILLIMETERS)

PIN NUMBERS (For reference only)

411T

411, 411D, 411DD

SCHEMATIC DIAGRAMS

411 411DD

411D 411T

SCHEMATICS ARE VIEWED FROM TERMINALS

GENERAL NOTES

- Relay contacts will exhibit no chatter in excess of 10 µsec or transfer in excess of 1 µsec.
- “Typical” characteristics are based on available data and are best estimates. No on-going verification tests are performed.
- Unless otherwise specified, parameters are initial values.
- For reference only. Coil resistance not directly measurable at relay terminals due to internal series semiconductor, 411DD and 411T only.
- Unless otherwise specified, relays will be supplied with either gold-plated or solder-coated leads.
- The slash and characters appearing after the slash are not marked on the relay.
- Limit Base Emitter current to 15 mA_{dc}.
- Applicable to all coil voltages. See Base current to turn on.
- Screened HI-REL versions available. Contact factory.
-

TYPICAL LOGIC INTERFACE (See Note 8)

Notes:
Logic 1 activates the relay.
Logic 0 de-activates the relay.
Vcc = logic bias power.
Vr = coil energization voltage.

Teledyne Part Numbering System for T²R[®] Established Reliability Relay

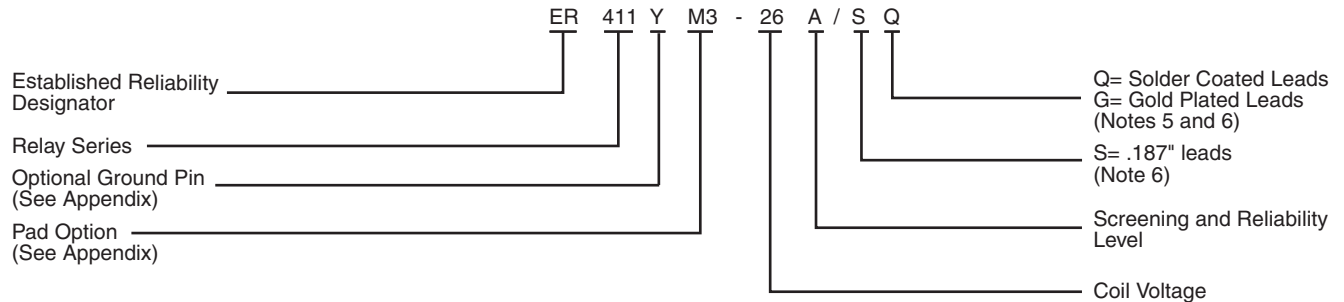

Teledyne Part Numbering System for Military Qualified (JAN) Relays

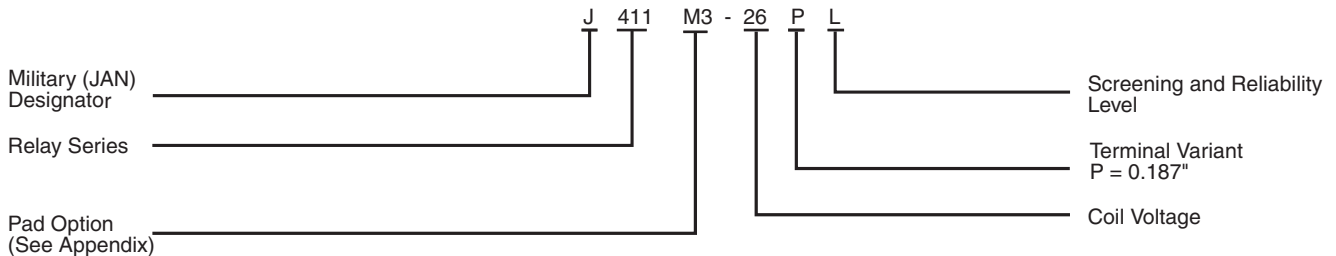

Appendix A: Spacer Pads

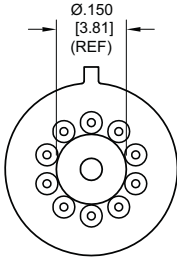
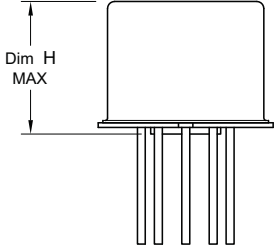
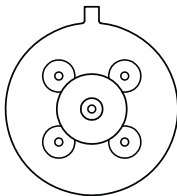
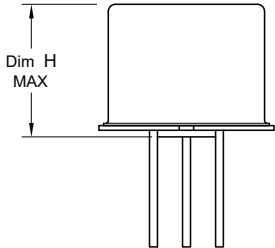
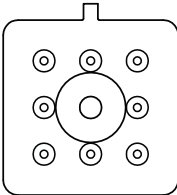
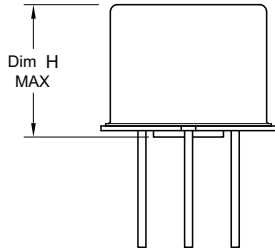
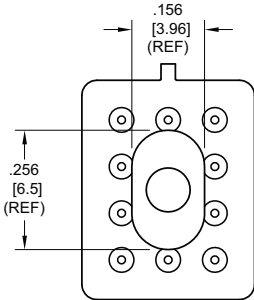
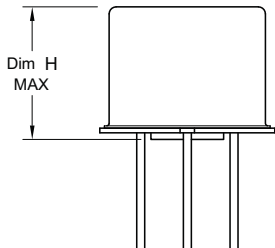
Pad designation and bottom view dimensions	Height	For use with the following:	Dim. H Max.
 <p style="text-align: center;">“M4” Pad for TO-5</p>		ER411T ER412, ER412D, ER412DD	.295 (7.49)
		712, 712D, 712TN, RF300, RF310, RF320	.300 (7.62)
		ER420, ER422D, ER420DD, 421, ER421D, ER421DD, ER422, ER422D, ER422DD, 722, 722D, RF341	.305 (7.75)
		ER431T, ER432T, ER432, ER432D, ER432DD	.400 (10.16)
		732, 732D, 732TN, RF303, RF313, RF323	.410 (10.41)
		RF312	.350 (8.89)
 <p style="text-align: center;">“M4” Pad for TO-5</p>		ER411, ER411D, ER411DD	.295 (7.49)
		ER431, ER431D, ER431DD	.400 (10.16)
		RF311	.300 (7.62)
		RF331	.410 (10.41)
 <p style="text-align: center;">“M4” Pad for Centigrid®</p>		172, 172D	.305 (7.75)
		ER114, ER114D, ER114DD, J114, J114D, J114DD	.300 (7.62)
		ER134, ER134D, ER134DD, J134, J134D, J134DD	.400 (10.16)
		RF100	.315 (8.00)
		RF103	.420 (10.67)
 <p style="text-align: center;">“M9” Pad for Centigrid®</p>		122C, A152	.320 (8.13)
		ER116C, J116C	.300 (7.62)
		ER136C, J136C	.400 (10.16)
		RF180	.325 (8.25)
		A150	.305 (7.75)

Notes:

1. Spacer pad material: Polyester film.
2. To specify an “M4” or “M9” spacer pad, refer to the mounting variants portion of the part numbering example in the applicable datasheet.
3. Dimensions are in inches (mm).
4. Unless otherwise specified, tolerance is $\pm .010$ (.25).
5. Add 10 m Ω to the contact resistance show in the datasheet.
6. Add 0.01 oz. (0.25 g) to the weight of the relay assembly shown in the datasheet.

Appendix A: Spreader Pads

Pad designation and bottom view dimensions	Height	For use with the following:	Dim. H Max.
<p>“M” Pad <u>5/</u> <u>6/</u> <u>9/</u></p>		ER411T, J411T, ER412, ER412D ER412DD, J412, J412D, J412DD ER412T, J412T	.388 (9.86)
		712, 712D, 712TN	.393 (9.99)
		ER431T, J431T, ER432, ER432D ER432DD, J432, J432D, J432DD ER432T, J432T	.493 (12.52)
		732, 732D, 732TN	.503 (12.78)
		ER420, J420, ER420D, J420D ER420DD, J420DD, ER421, J421 ER421D, J421D, ER421DD J422D, ER422DD, J422DD, 722	.398 (10.11)
<p>“M2” Pad <u>7/</u> <u>8/</u></p>		ER411T ER412, ER412D, ER412DD J412, J412D, J412DD	.441 (11.20)
		712, 712D	.451 (11.46)
		ER421, ER421D, ER421DD 722, 732D	.451 (11.46)
		ER431T ER432, ER432D, ER432DD	.546 (13.87)
		732, 732D	.556 (14.12)
<p>“M3” Pad <u>5/</u> <u>6/</u> <u>9/</u></p>		ER411, ER411D, ER411DD ER411TX ER412X, ER412DX, ER412DDX ER412TX	.388 (9.86)
		712X, 712DX, 712TNX	.393 (9.99)
		ER420X, ER420DX, ER420DDX ER421X, ER421DX, ER421DDX ER422X, ER422DX ER422DDX, 722X, 722DDX	.398 (10.11)
		ER431, ER431D, ER431DD ER431TX ER432X, ER432DX, ER432DDX ER432TX	.493 (12.52)
		732X, 732DX, 732TNX	.503 (12.78)

Notes:

1. Spreader pad material: Diallyl Phthalate.
2. To specify an “M”, “M2” or “M3” spreader pad, refer to the mounting variants portion of the part number example in the applicable datasheet.
3. Dimensions are in inches (mm).
4. Unless otherwise specified, tolerance is $\pm .010$ ” (0.25).
- 5/. Add 25 m Ω to the contact resistance shown in the datasheet.
- 6/. Add .01 oz. (0.25 g) to the weight of the relay assembly shown in the datasheet.
- 7/. Add 50 m Ω to the contact resistance shown in the datasheet.
- 8/. Add 0.025 oz (0.71 g) to the weight of the relay assembly shown in the datasheet.
- 9/. M3 pad to be used only when the relay has a center pin (e.g. ER411M3-12A, 722XM3-26.)

Appendix A: Ground Pin Positions



TO-5 Relays:

ER411T, ER412, ER412T, ER420, ER421, ER422,
ER431T, ER432, ER432T, 712, 712TN, 400H, 400K,
400V, RF300, RF303, RF341, RF312, RF310, RF313,
RF320, RF323



TO-5 Relays:

ER411, ER431, RF311, RF331



Centigrid® Relays:

RF180, ER116C, 122C, ER136C



Centigrid® Relays:

RF100, RF103, ER114, ER134, 172

- Indicates ground pin position
- Indicates glass insulated lead position
- ◎ Indicates ground pin or lead position depending on relay type

NOTES

1. Terminal views shown
2. Dimensions are in inches (mm)
3. Tolerances: $\pm .010$ ($\pm .25$) unless otherwise specified
4. Ground pin positions are within $.015$ (0.38) dia. of true position
5. Ground pin head dia., 0.035 (0.89) ref: height 0.010 (0.25) ref.
6. Lead dia. 0.017 (0.43) nom.