

X Band Driver Amplifier

GaAs Monolithic Microwave IC

Description

The CHA5012 chip is a monolithic two-stage medium power amplifier designed for X band applications.

This device is manufactured using a GaInP HBT process, including, via holes through the substrate and air bridges. A nitride layer protects the transistors and the passive components. Special heat removal techniques are implemented to guarantee high reliability.

To simplify the assembly process:

- the backside of the chip is both RF and DC grounded
- bond pads and back side are gold plated for compatibility with eutectic die attach method and thermosonic or thermocompression bonding process.

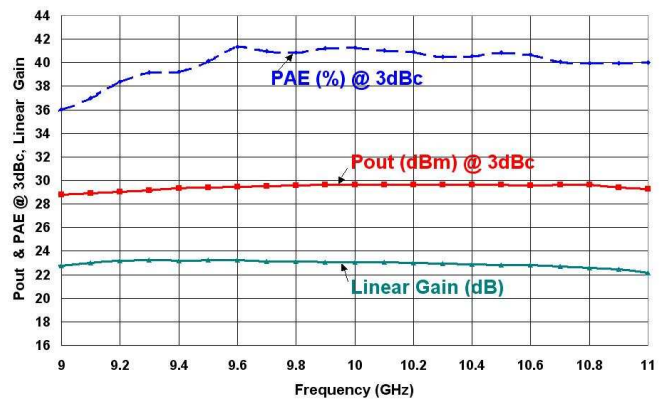
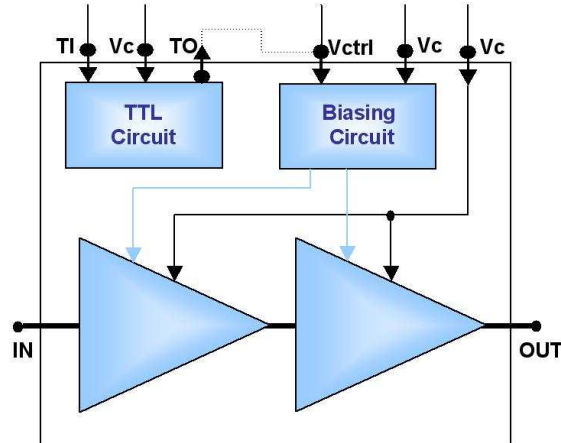

Pout & PAE @ 3dBc and Linear Gain (Temperature 25°C)

Main Features

- Frequency band : 9.2 -10.8 GHz
- Output power (P3dB) : 29.5 dBm
- Power added efficiency (PAE_3dBc) : 40 %
- Two biasing modes:
 - Digital control thanks to TTL interface
 - Analog control thanks to Biasing circuit
- Chip size: 2.87 x 1.47 x 0.1 mm³

Main Characteristics

Tamb = +25°C, Vc = +7.5V (Pulse 100µs 20%)

Symbol	Parameter	Min	Typ	Max	Unit
Fop	Operating frequency range	9.2		10.8	GHz
G	Small signal gain	21	23		dB
P3dB	Output power at 3dB compression		29.5		dBm
Icq	Power supply quiescent current		200		mA

ESD Protections : Electrostatic discharge sensitive device observe handling precautions

Electrical Characteristics

Vc= +7.5V (Pulse 100µs 20%)

Symbol	Parameter	Min	Typ	Max	Unit
Top	Operating temperature range	-40		80	°C
Fop	Operating frequency range	9.2		10.8	GHz
G	Small signal gain at 25°C	21	23	25	dB
ΔG	Small signal gain flatness at 25°C		±0.5		dB
ΔG_T	Linear gain variation vs temperature		-0.03		dB/°C
P1dB	Output power at 1dB compression at 25°C		28		d Bm
P3dB	Output power at 3dB compression at 25°C	28	29.5		dBm
	Output power at 3dB compression at 80°C	27.5	29		
PAE_3dBc	Pae at 3dB compression at 25°C	33	40		%
	Pae at 3dB compression at 80°C	30	37		
dBS11	Input Return Loss		-12	-10	dB
dBS22	Output Return Loss		-10	-7	dB
Vc	Power supply voltage		7.5		V
Icq	Power supply quiescent current (1)		200		mA
Ic_3dBc	Consumption under 3dB compression		290		mA
Vctrl	Collector current control voltage		5		V
Ictrl	Biasing circuit consumption		10		mA
TI	TTL input voltage		5		V
I_TI	TTL input current		1		mA

(1) For Vc=7.5V, TTL interface settles Icq to 200 mA . If needed, Icq can be tuned thanks to Vctrl if the biasing circuit is used.

Absolute Maximum Ratings (2)

Tamb = 25°C

Symbol	Parameter	Values	Unit
Cmp	Compression level (3)	9	dB
Vc	Power supply voltage (4)	10	V
Icq	Power supply quiescent current	320	mA
Ic_sat	Power supply current in saturation	350	mA
Vct	Collector current control voltage	6.5	V
Tj	Maximum Junction temperature (5)	175	°C
Tstg	Storage temperature range	-55 to +125	°C

- (2) Operation of this device above anyone of these parameters may cause permanent damage.
- (3) For higher compression the level limit can be increased by decreasing the voltage Vc using the rate 0.5 V / dBc
- (4) Without RF input power
- (5) Equivalent Thermal Resistance to Backside : 55°C/ W

Typical measurement characteristics

Measurement :

Tamb=25°C, Vc=7.5V, Ic (Quiescent) = 200mA, Pulse width=100µs, Duty cycle = 20%

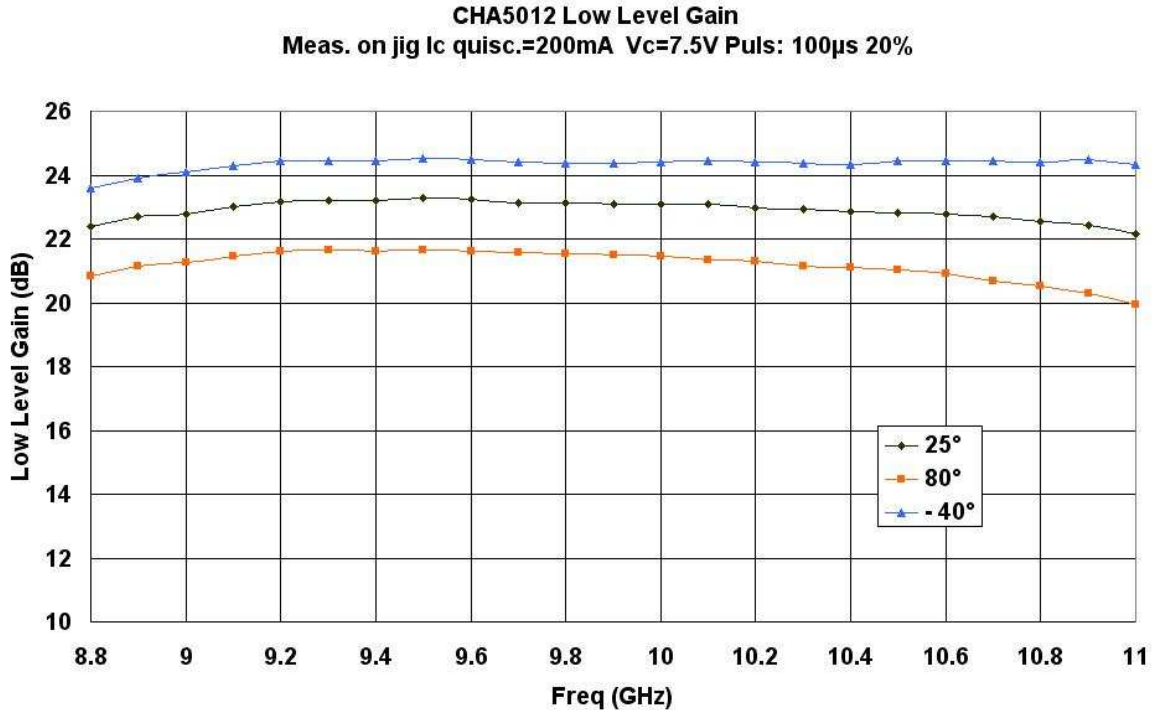

Linear gain vs frequency and temperature

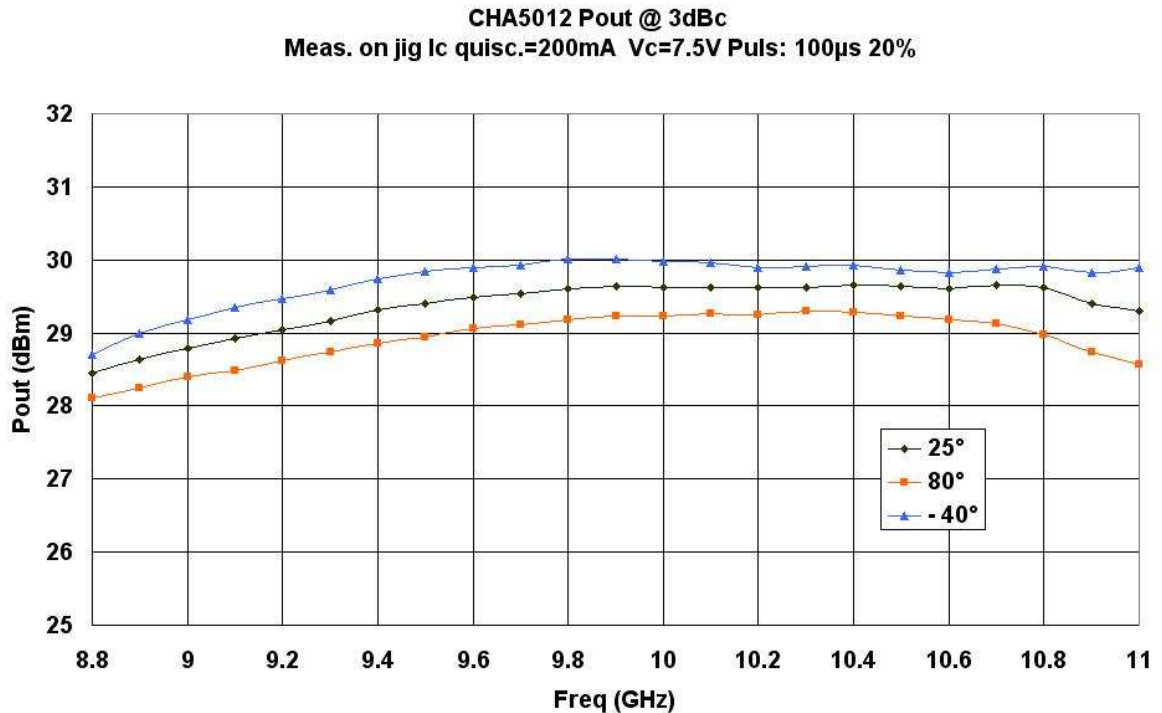

Output Power@3dBc vs frequency and temperature

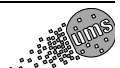

CHA5012 PAE @ 3dBc
 Meas. on jig I_c quisc.=200mA V_c=7.5V Puls: 100µs 20%

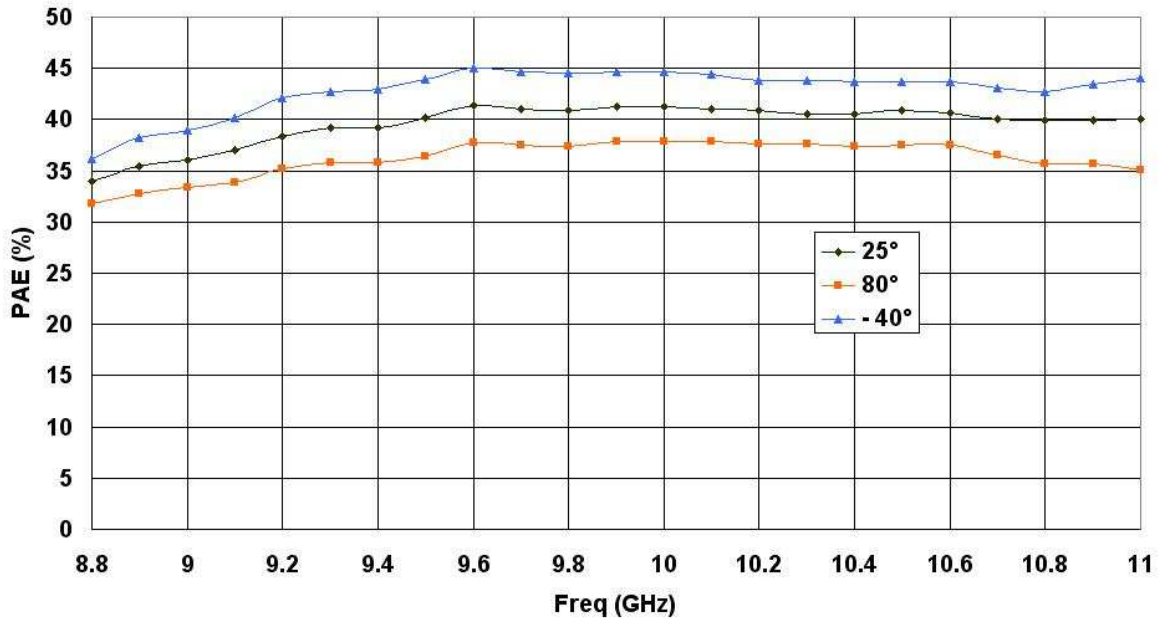

Power added efficiency@3dBc vs frequency

CHA5012 I_c @ 3dBc
 Meas. on jig T_I=4V V_c=7.5V Puls: 100µs 20%

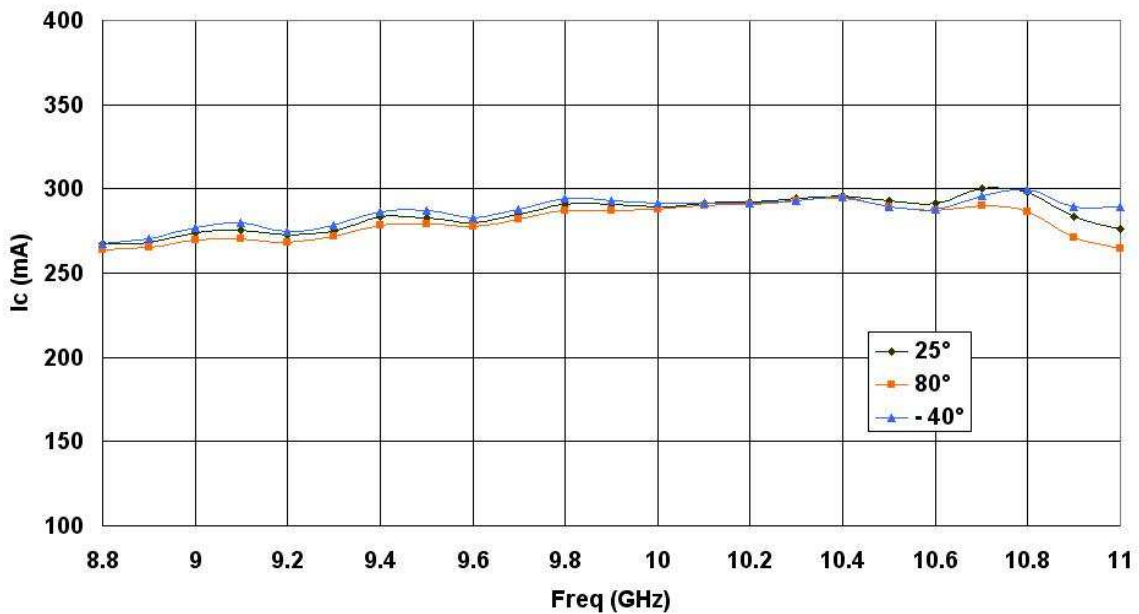

Collector current @3dBc vs frequency

Preliminary

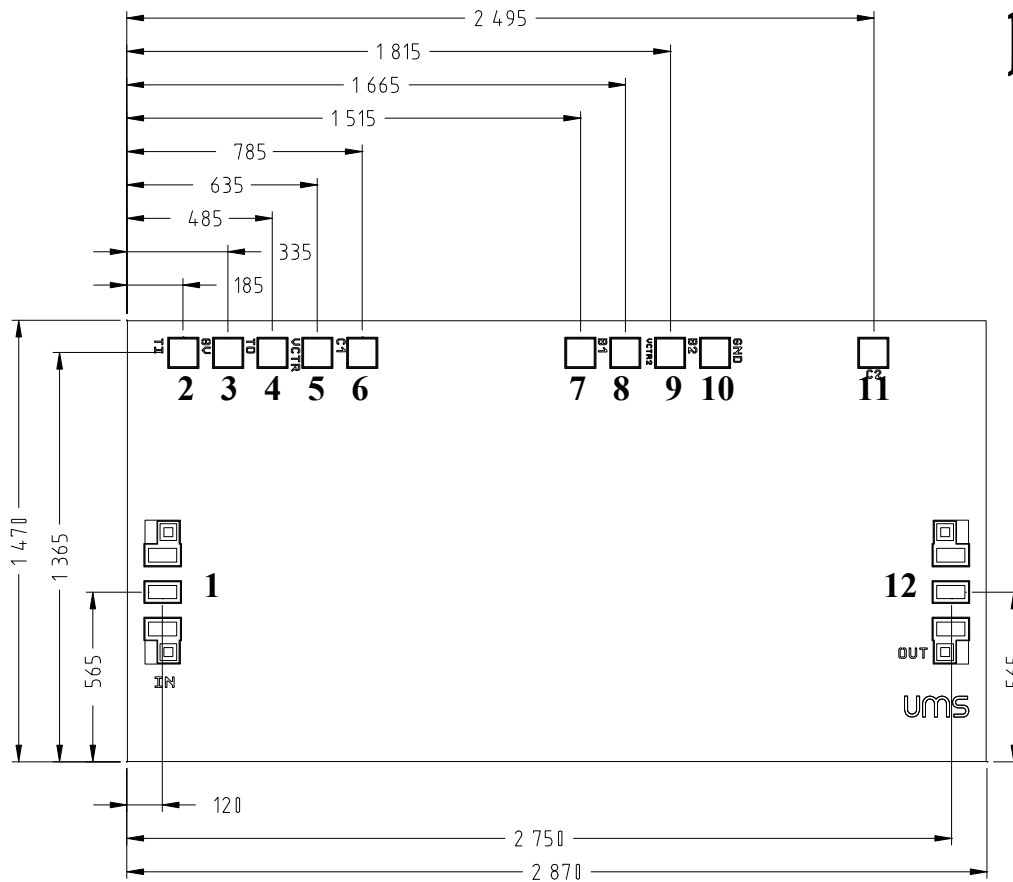

UNITS : μm
Tol : $\pm 35\mu\text{m}$

Chip Mechanical Data and Pin references

Chip thickness = $100 \pm 10 \mu\text{m}$
RF pads (1, 12) = $118 \times 68 \mu\text{m}^2$
DC pads (2, 3, 4, 5, 9, 6, 7, 8, 9, 10, 11) = $96 \times 96 \mu\text{m}^2$

Pin number	Pin name	Description
1	IN	Input RF port
7, 9		NC
5, 8	Vctrl	Collector current control voltage
2	TI	TTL input
4	TO	TTL output
10	GND	Ground (NC)
3, 6, 11	Vc	Power supply voltage
12	OUT	Output RF port

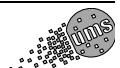

Assembly recommendations in test fixture (using TTL interface)

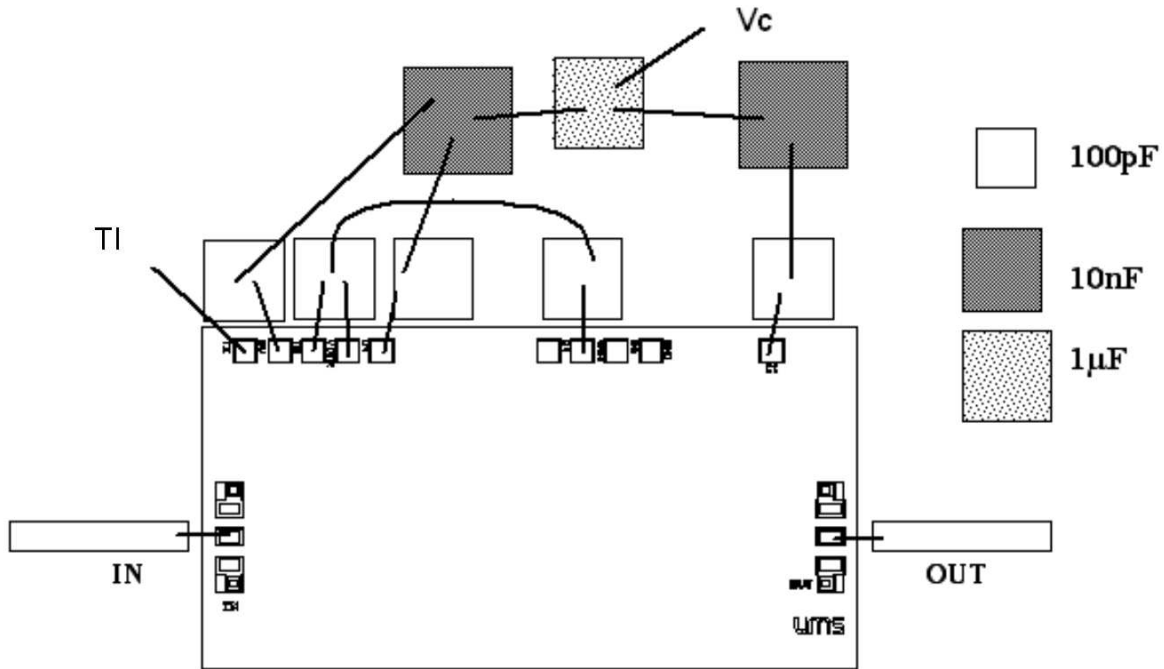

Assembly recommendations in test fixture (using Biasing circuits)

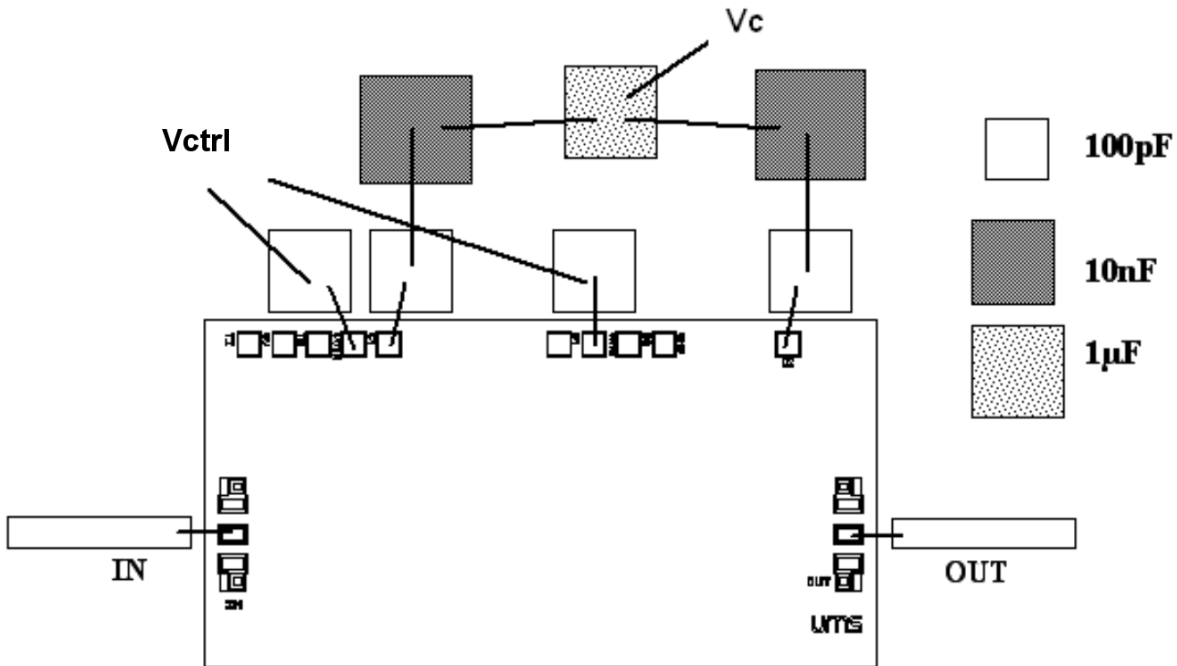

Note:

Ordering Information

Chip form : CHA5012-99F/00

Information furnished is believed to be accurate and reliable. However **United Monolithic Semiconductors S.A.S.** assumes no responsibility for the consequences of use of such information nor for any infringement of patents or other rights of third parties which may result from its use. No license is granted by implication or otherwise under any patent or patent rights of **United Monolithic Semiconductors S.A.S.**. Specifications mentioned in this publication are subject to change without notice. This publication supersedes and replaces all information previously supplied. **United Monolithic Semiconductors S.A.S.** products are not authorised for use as critical components in life support devices or systems without express written approval from **United Monolithic Semiconductors S.A.S.**