



UT20N03

Power MOSFET

N-CHANNEL ENHANCEMENT MODE

FEATURES

- * $R_{DS(ON)} = 20m\Omega @ V_{GS} = 10 V$
- * Low capacitance
- * Optimized gate charge
- * Fast switching capability
- * Avalanche energy specified

SYMBOL

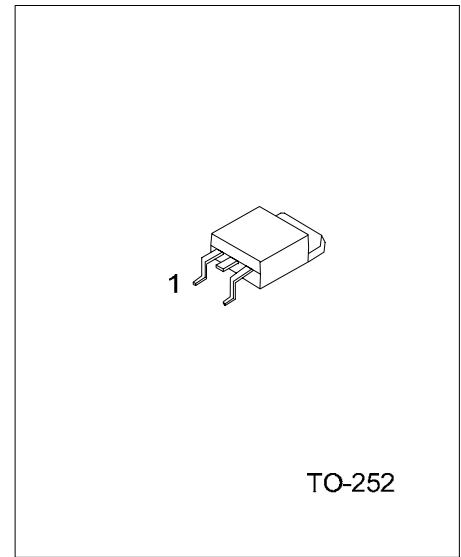
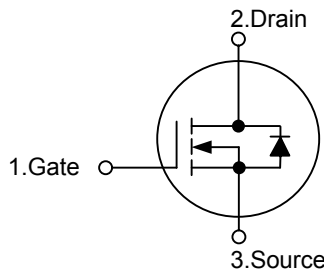

*Pb-free plating product number: UT20N03L

ORDERING INFORMATION

Ordering Number		Package	Pin Assignment			Packing
Normal	Lead Free Plating		1	2	3	
UT20N03-TN3-R	UT20N03L-TN3-R	TO-252	G	D	S	Tape Reel
UT20N03-TN3-T	UT20N03L-TN3-T	TO-252	G	D	S	Tube

<p>UT20N03L-TN3-R</p> <p>(1)Packing Type</p> <p>(2)Package Type</p> <p>(3)Lead Plating</p>	<p>(1) R: Tape Reel, T: Tube</p> <p>(2) TN3: TO-252</p> <p>(3) L: Lead Free Plating, Blank: Pb/Sn</p>
--	---

■ ABSOLUTE MAXIMUM RATINGS ($T_J=25^{\circ}\text{C}$, unless otherwise specified)

PARAMETER		SYMBOL	RATINGS	UNIT
Drain-Source Voltage		V_{DSS}	30	V
Gate-Source Voltage		V_{GSS}	± 20	V
Continuous Drain Current		I_D	20	A
Pulsed Drain Current (Note 1)		I_{DM}	120	
Avalanche Energy	Single Pulsed (Note 2)	E_{AS}	15	mJ
	Repetitive (Note 1)	E_{AR}	6	
Peak Diode Recovery (Note 3)		dv/dt	6	KV/ μs
Power Dissipation		P_D	60	W
Junction Temperature		T_J	+175	
Storage Temperature		T_{STG}	-55 ~ +175	

Note: Absolute maximum ratings are those values beyond which the device could be permanently damaged.

Absolute maximum ratings are stress ratings only and functional device operation is not implied.

■ THERMAL DATA

PARAMETER	SYMBOL	MIN	TYP	MAX	UNIT
Junction-to-Ambient	θ_{JA}			100	/W
Junction-to-Case	θ_{JC}		1.7	2.5	/W

■ ELECTRICAL CHARACTERISTICS ($T_J=25^{\circ}\text{C}$, unless otherwise specified)

PARAMETER	SYMBOL	TEST CONDITIONS	MIN	TYP	MAX	UNIT
OFF CHARACTERISTICS						
Drain-Source Breakdown Voltage	BV_{DSS}	$V_{GS}=0\text{V}, I_D=250\mu\text{A}$	30			V
Drain-Source Leakage Current	I_{DSS}	$V_{DS}=30\text{V}, V_{GS}=0\text{V}$			1	μA
Gate-Source Leakage Current	I_{GSS}	$V_{DS}=0\text{V}, V_{GS}=\pm 20\text{V}$			± 100	nA
ON CHARACTERISTICS						
Gate-Threshold Voltage	$V_{GS(TH)}$	$V_{DS}=V_{GS}, I_D=25\mu\text{A}$	1.2	1.6	2	V
Drain-Source On-State Resistance	$R_{DS(ON)}$	$V_{GS}=4.5\text{V}, I_D=15\text{A}$		22.9	31	m Ω
		$V_{GS}=10\text{V}, I_D=15\text{A}$		15.5	20	
DYNAMIC CHARACTERISTICS						
Input Capacitance	C_{ISS}	$V_{DS}=25\text{V}, V_{GS}=0\text{V}, f=1\text{MHz}$		530	700	pF
Output Capacitance	C_{OSS}		200	275		
Reverse Transfer Capacitance	C_{RSS}		60	90		
SWITCHING CHARACTERISTICS						
Turn-On Delay Time	$t_{D(ON)}$	$V_{GS}=10\text{V}, V_{DD}=15\text{V}, R_G=12.7\Omega, I_D=15\text{A}$		6.2	9.3	ns
Turn-On Rise Time	t_R		11	17		
Turn-Off Delay Time	$t_{D(OFF)}$		23	24		
Turn-Off Fall-Time	t_F		18	27		
Gate-Source Charge	Q_{GS}	$V_{DD}=15\text{V}, I_D=15\text{A}$		2.5	3.1	nC
Gate-Drain Charge	Q_{GD}		6.4	9.6		
Gate Charge Total	Q_G		$V_{DD}=15\text{V}, I_D=15\text{A}, V_{GS}=0\sim 5\text{V}$	8.4	11	
SOURCE- DRAIN DIODE RATINGS AND CHARACTERISTICS						
Drain-Source Diode Forward Voltage	V_{SD}	$V_{GS}=0\text{V}, I_F=30\text{A}$		1.1	1.4	V
Maximum Continuous Drain-Source Diode Forward Current	I_S				30	A
Maximum Pulsed Drain-Source Diode Forward Current	I_{SM}				120	
Reverse Recovery Time	t_{RR}	$V_R=15\text{V}, I_F=I_S, di_F/dt=100\text{A}/\mu\text{s}$		15	18	ns
Reverse Recovery Charge	Q_{RR}			2	3	nC

Notes: 1. Repetitive Rating : Pulse width limited by maximum junction temperature

2. $I_D=15\text{A}, V_{DD}=25\text{V}, R_G=25\Omega$, Starting $T_J=25^{\circ}\text{C}$

3. $I_S=30\text{A}, V_{DS}=24\text{V}, di/dt=200\text{A}/\mu\text{s}, T_{J(MAX)}=175$

4. Pulse Test: Pulse width $\leq 300\mu\text{s}$, Duty cycle $\leq 2\%$

5. Essentially independent of operating temperature

TYPICAL CHARACTERISTICS

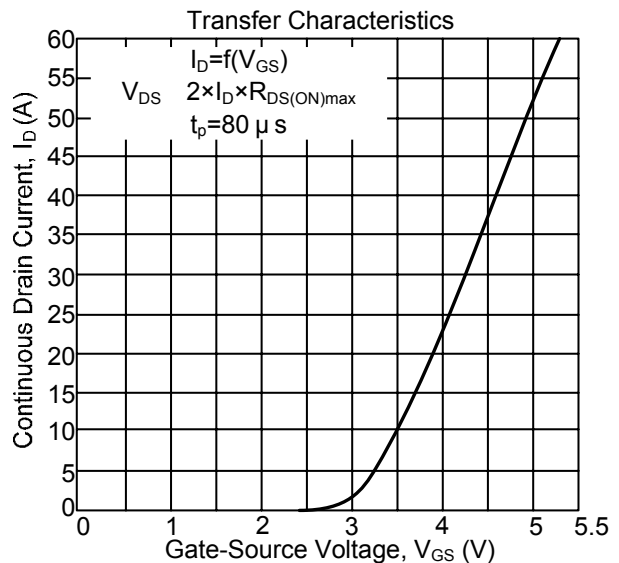
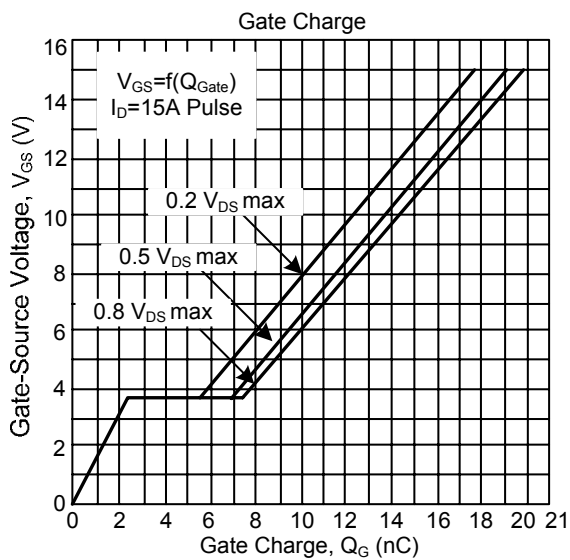
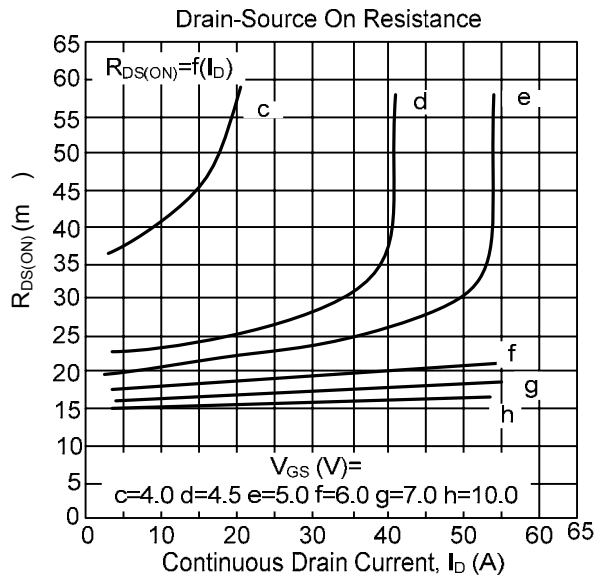
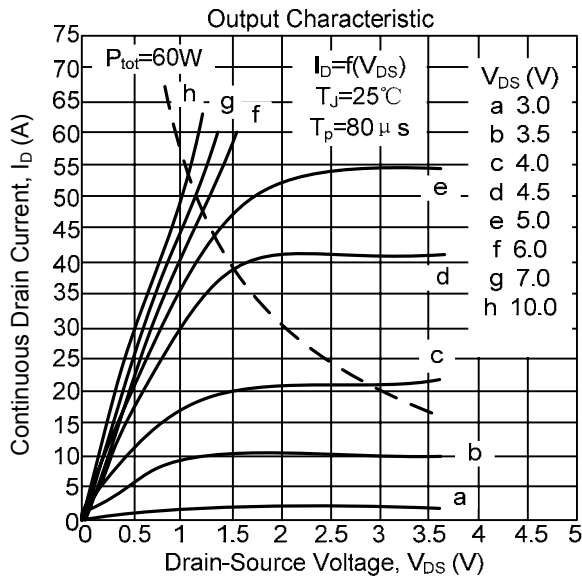
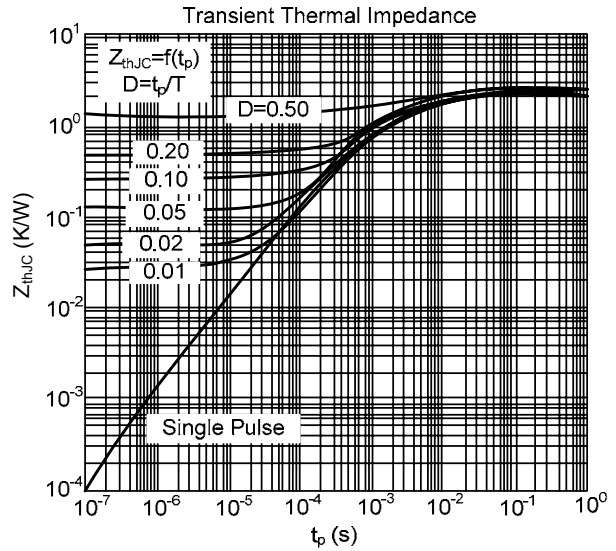
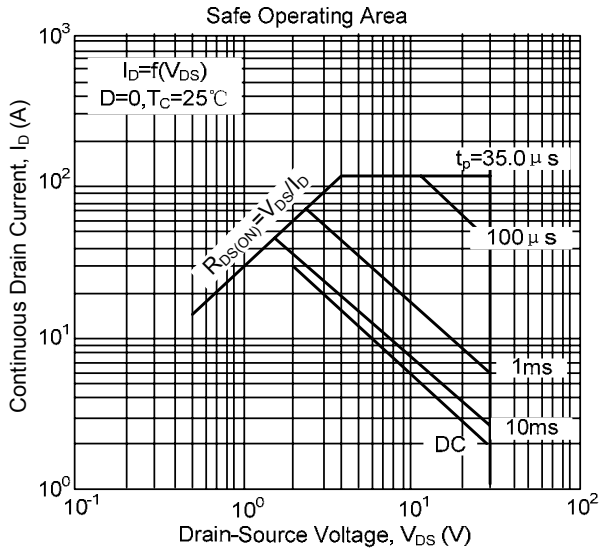

■ TYPICAL CHARACTERISTICS(Cont.)

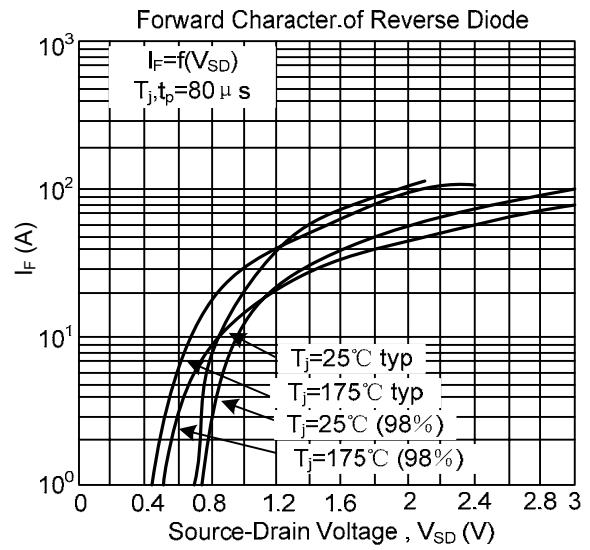
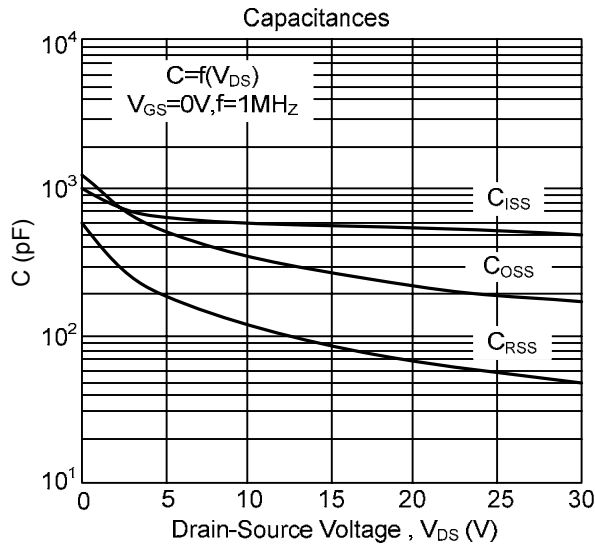

UTC assumes no responsibility for equipment failures that result from using products at values that exceed, even momentarily, rated values (such as maximum ratings, operating condition ranges, or other parameters) listed in products specifications of any and all UTC products described or contained herein. UTC products are not designed for use in life support appliances, devices or systems where malfunction of these products can be reasonably expected to result in personal injury. Reproduction in whole or in part is prohibited without the prior written consent of the copyright owner. The information presented in this document does not form part of any quotation or contract, is believed to be accurate and reliable and may be changed without notice.