

■ Package Dimension:

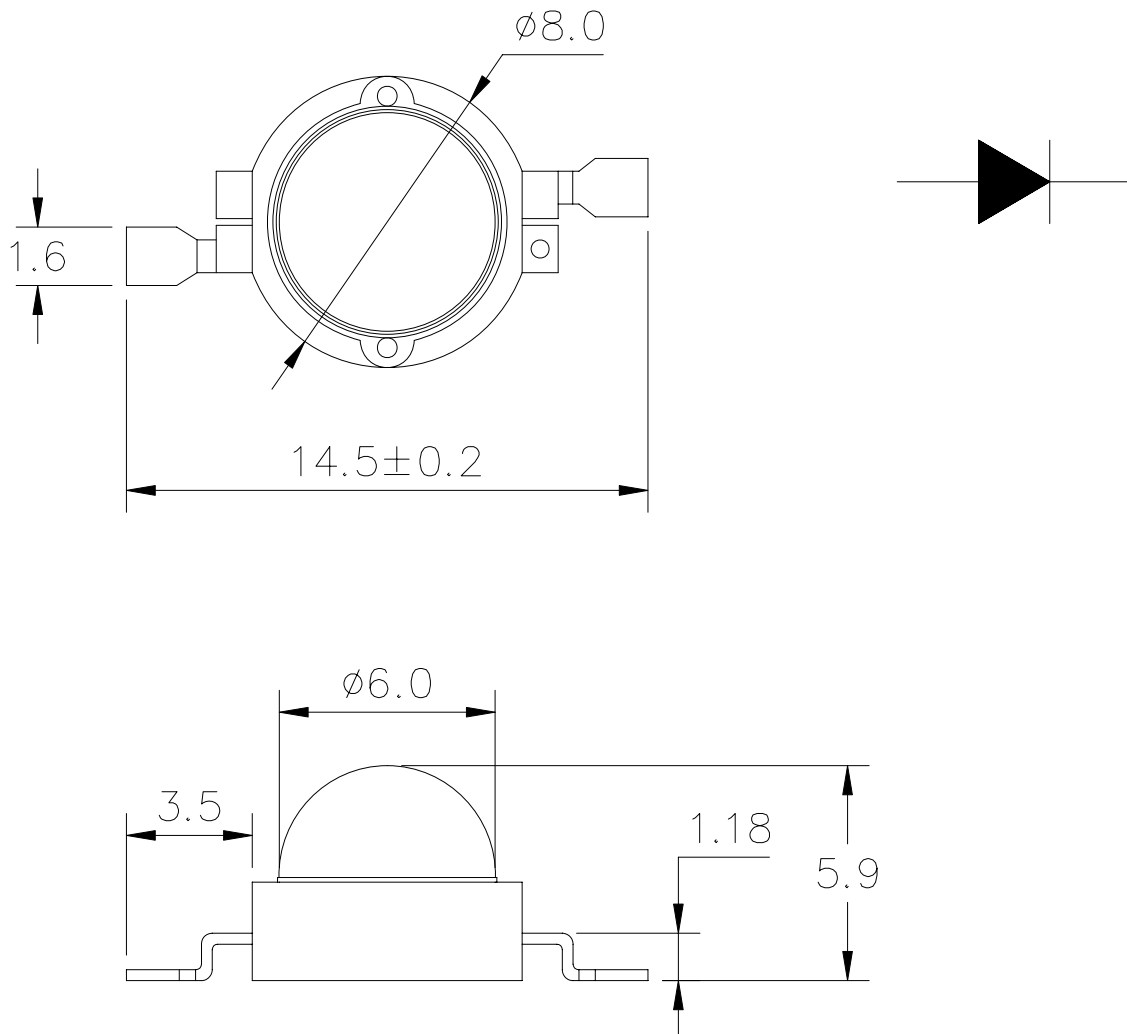

Part NO.	Housing	Emitting Color	Lens Color
AL-6R01WC-60	----	Red-Orange	Water Clear

Notes:

1. All dimensions are in millimeters (inches).
2. Tolerance is $\pm 0.25\text{mm}$ (.010") unless otherwise noted.
3. Protruded resin under flange is 1.0mm(.04") max.
4. Lead spacing is measured where the leads emerge from the package.
5. Specifications are subject to change without notice.
6. This data-sheet only valid for six months.

■ Absolute Maximum Ratings at Ta=25°C

Parameter	Symbol	MAX.	Unit
Forward Current	I _F	350	mA
Peak pulsed forward current	I _{PF}	500	mA
Power Dissipation	P _D	1	W
Reverse Voltage	V _R	5	V
Operating Temperature Range	T _{opr}	-40 to +85	°C
Storage Temperature Range	T _{stg}	-40 to +85	°C
Soldering Temperature (Max.)	T _{sol}	260 ± 5	seconds

■ Electrical Optical Characteristics at Ta=25°C

Parameter	Symbol	Min.	Typ.	Max.	Unit	Test Condition
Luminous Flux	Flux	30	40	---	Lm	I _F =350mA
Forward Voltage	V _F	2.0	2.5	3.0	V	I _F =350mA
Dominant Wavelength	λ d	610	615	620	nm	I _F =350mA
Spectral Half-Width	Δ λ 1/2	---	20	---	nm	I _F =350mA
Temperature Coefficient or Dominant Wavelength	Δ λ d / Δ Tj	---	0.05	---	nm/°C	I _F =350mA
Temperature Coefficient of V _F	Δ V _F / Δ Tj	---	-2.0	---	mV/°C	I _F =350mA
Thermal Resistance Junction to Board	----	---	15	---	°C/W	I _F =350mA
Viewing Angle	2θ1/2	---	60	---	Deg	I _F =350mA

■ Reliability test items and conditions :

NO	ITEM	Test Conditions	Test hours/cycle	Sample Q'ty	Ac/Re
1	Solder Heat	Temp : 260°C±5°C	5 sec	30 pcs	0/1
2	Temperature Cycle	-40°C 30min -25°C 5min -105°C 30min -25°C 5min	100 cycles	30 pcs	0/1
3	Thermal Shock	-40°C 5min -105°C 5min	20 cycles	30 pcs	0/1
4	High Temperature Storage	Temp : 85°C	1000 hrs	30 pcs	0/1
5	Low Temperature Storage	Temp : -35°C	1000 hrs	30 pcs	0/1
6	DC Operating Life	I _F =350mA	1000 hrs	30 pcs	0/1
7	High Temperature / High Humidity	T _a =60°C R.H 90%	1000 hrs	30 pcs	0/1

■ Typical electro-optical characteristics curves :

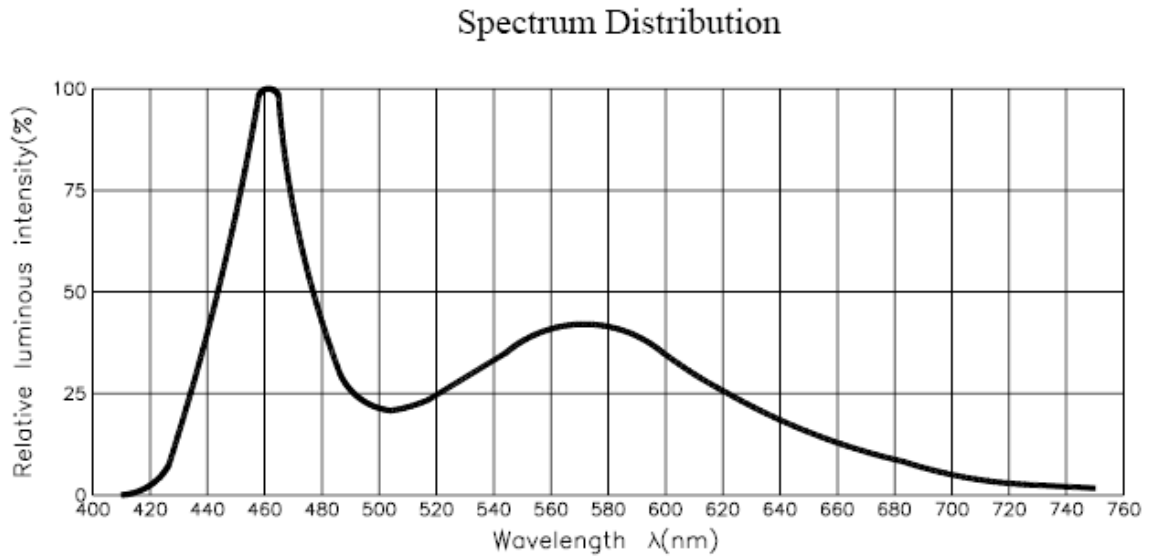
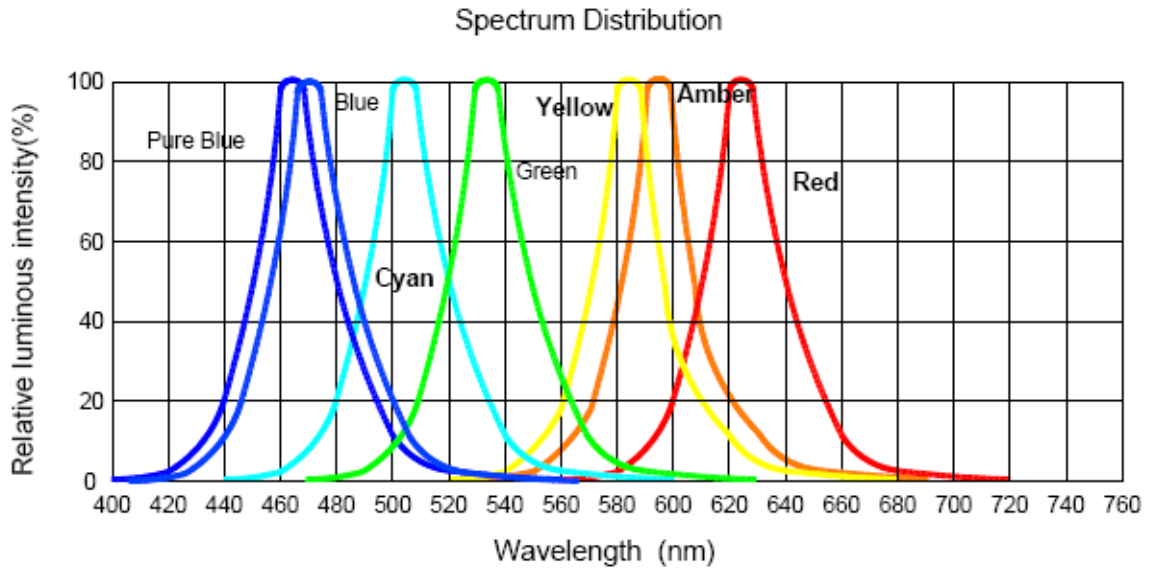

■ Typical electro-optical characteristics curves :

Forward Current VS. Forward Voltage

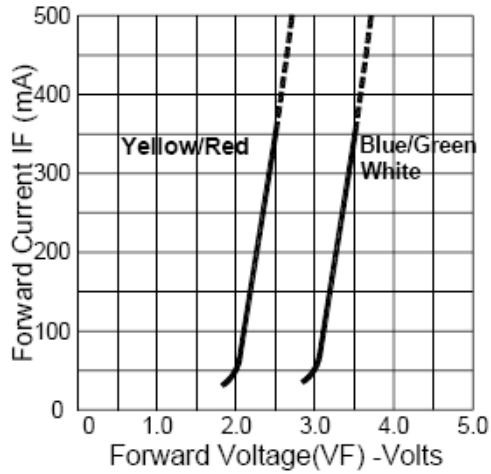

Luminous Intensity VS. Forward Current

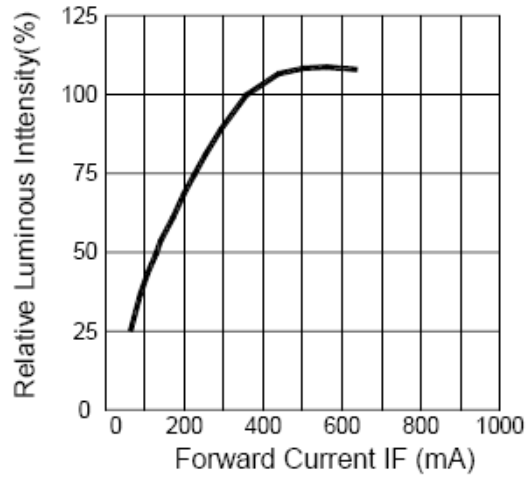

Forward Current VS. Ambient Temperature

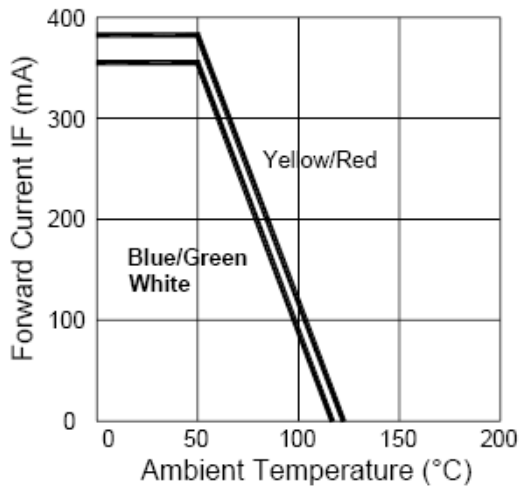

Radiation Diagram

