

## SOT-23 Plastic-Encapsulate MOSFETS P-Channel Enhancement Mode Field Effect Transistor

### General Description

The AO3407 uses advanced trench technology to provide excellent  $R_{DS(on)}$  with low gate charge. This device is suitable for use as a load switch or in PWM applications.

### MARKING

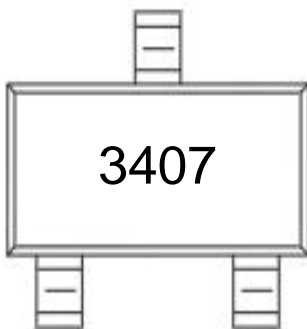

### Equivalent Circuit

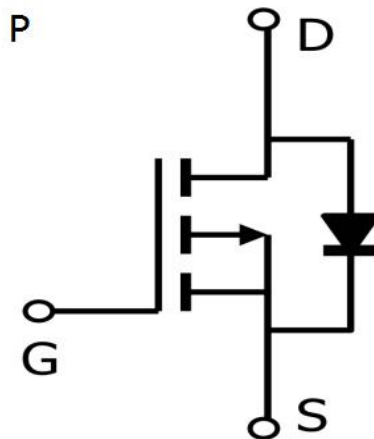

### SOT-23

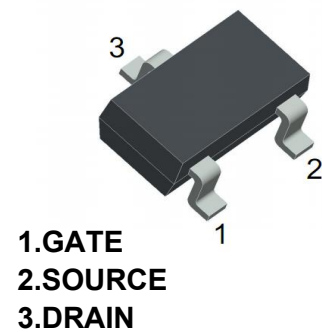

### Maximum ratings ( $T_a=25^{\circ}\text{C}$ unless otherwise noted)

Parameter	Symbol	Value	Unit
Drain-Source Voltage	$V_{DS}$	-30	V
Gate-Source Voltage	$V_{GS}$	$\pm 20$	V
Continuous Drain Current	$I_D$	-4.1	A
Power Dissipation	$P_D$	350	mW
Thermal Resistance from Junction to Ambient	$R_{\theta JA}$	357	$^{\circ}\text{C}/\text{W}$
Junction Temperature	$T_J$	150	$^{\circ}\text{C}$
Storage Temperature	$T_{stg}$	-55~+150	$^{\circ}\text{C}$

**Electrical characteristics (T<sub>a</sub>=25°C unless otherwise noted)**

Parameter	Symbol	Test Condition	Min	Typ	Max	Units
<b>Static characteristics</b>						
Drain-source breakdown voltage	BV <sub>DSS</sub>	V <sub>GS</sub> = 0V, I <sub>D</sub> = -250μA	-30			V
Zero gate voltage drain current	I <sub>DSS</sub>	V <sub>DS</sub> = -24V, V <sub>GS</sub> = 0V			-1	μA
Gate-source leakage current	I <sub>GSS</sub>	V <sub>GS</sub> = ±20V, V <sub>DS</sub> = 0V			±100	nA
Drain-source on-resistance (note 1)	R <sub>DS(on)</sub>	V <sub>GS</sub> = -10V, I <sub>D</sub> = -4.1A			60	mΩ
		V <sub>GS</sub> = -4.5V, I <sub>D</sub> = -3A			87	mΩ
Forward transconductance (note 1)	g <sub>FS</sub>	V <sub>DS</sub> = -5V, I <sub>D</sub> = -4A	5.5			S
Gate threshold voltage	V <sub>GS(th)</sub>	V <sub>DS</sub> = V <sub>GS</sub> , I <sub>D</sub> = -250μA	-1		-3	V
Diode forward voltage (note 1)	V <sub>SD</sub>	I <sub>S</sub> = -1A, V <sub>GS</sub> = 0V			-1	V
<b>Dynamic characteristics (note 2)</b>						
Input capacitance	C <sub>iss</sub>	V <sub>DS</sub> = -15V, V <sub>GS</sub> = 0V, f = 1MHz		700		pF
Output capacitance	C <sub>oss</sub>			120		pF
Reverse transfer capacitance	C <sub>rss</sub>			75		pF
<b>Switching Characteristics (note 2)</b>						
Turn-on delay time	t <sub>d(on)</sub>	V <sub>GS</sub> = -10V, V <sub>DS</sub> = -15V, R <sub>L</sub> = 3.6Ω, R <sub>GEN</sub> = 3Ω		8.6		ns
Turn-on rise time	t <sub>r</sub>			5.0		ns
Turn-off delay time	t <sub>d(off)</sub>			28.2		ns
Turn-off fall time	t <sub>f</sub>			13.5		ns

**Notes:**

1. Pulse test: Pulse width ≤300μs, duty cycle ≤2%.
2. These parameters have no way to verify.

Typical Characteristics

Output Characteristics

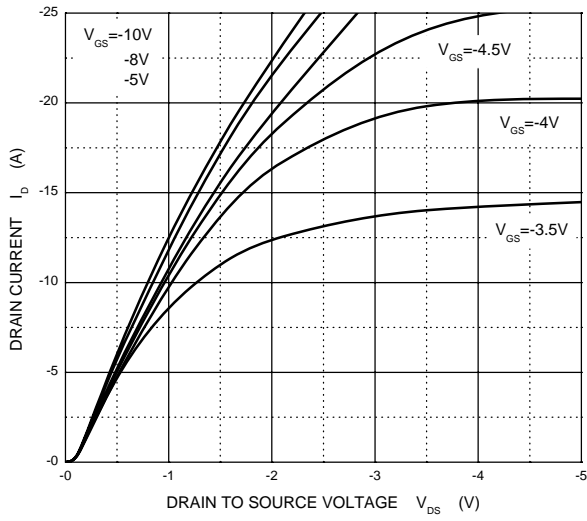

Transfer Characteristics

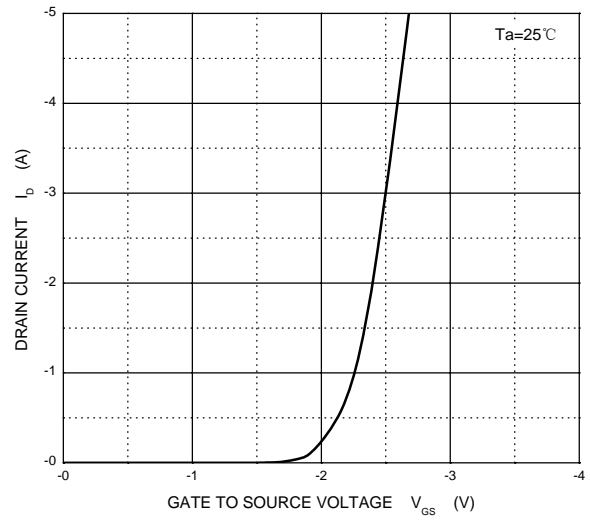

$R_{DS(ON)}$  —  $I_D$

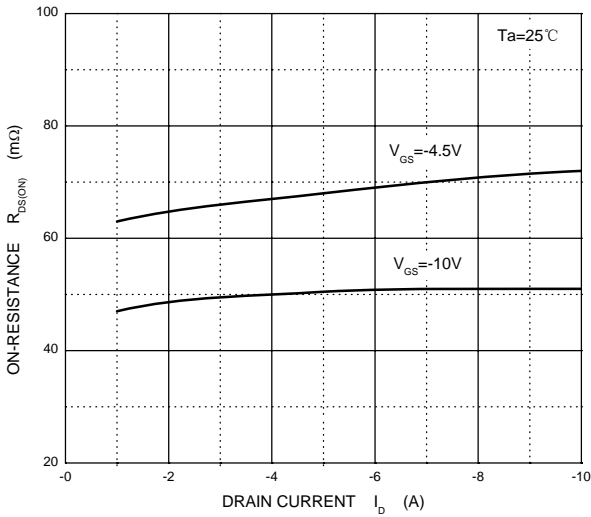

$R_{DS(ON)}$  —  $V_{GS}$

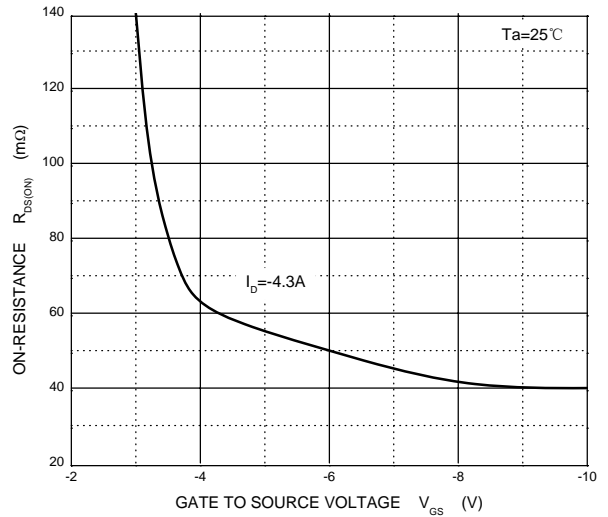

$I_S$  —  $V_{SD}$

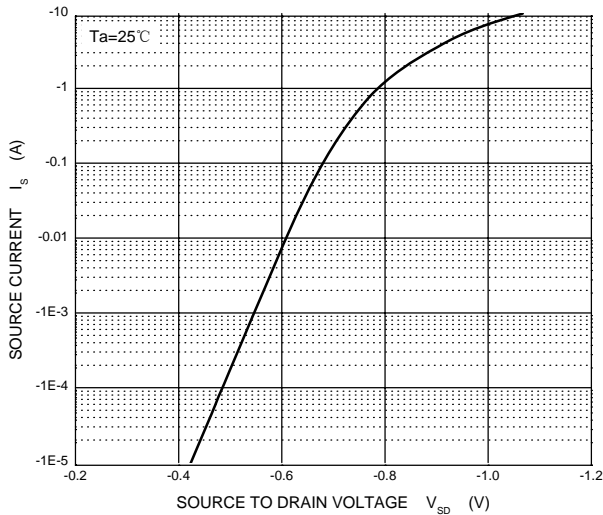

**PACKAGE OUTLINE**

Plastic surface mounted package; 3 leads

SOT-23

