

Specification

All exposed cast aluminum components are made of non corrosive pure aluminum copper free (Aluminum is less than .1% copper content.#356 alloy.)

Finish: All polyester powder baked coatings preceded with a 5 baths preparation process. Meets military grade MIL-C781706 with a 2000 hours salt spray test.

- Pulse rated medium base porcelain socket.
- 75W/600V thermoplastic compact fluorescent socket.
- One-piece molded silicone gasket with memory retention.
- High power factor CWA ballast. Or 98% P.F. electronic smart ballast with end of life detection for compact fluorescent.
- All stainless steel hardware.
- All Moving and removable parts are sealed with a memory retention silicone gasket.
- Cast aluminum swing out hinge mechanism for quick maintenance access.

- 1 - Cast aluminum removable gasketed top for quick and ease of ballast servicing.
- 2 - Standard specular multi facet reflector,with type III distribution.
- 3 - Cast aluminum sealed hinged glass frame, with perimeter memory retention embedded silicone gasket.
- 4 - Clear tempered clear glass lens

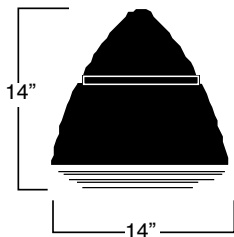
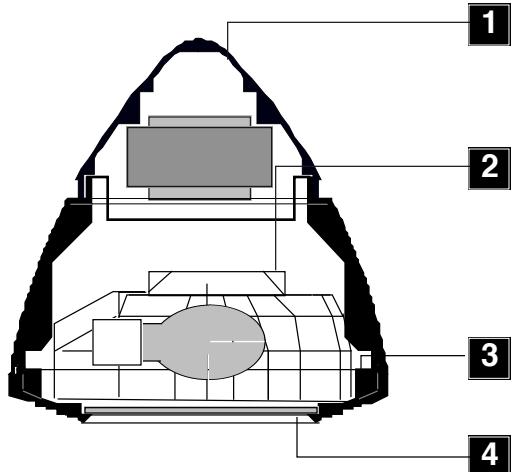

Note:
SPT20 series is a modular luminaire offered with an array of standard attachments to meet multiple installation requirements. Please specify desired mounting accessory with model number. (See page 116)



Photometry

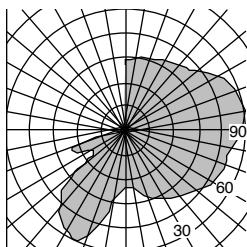

Separate updated technical specification sheets with related models and light sources with I.E.S formatted photometry are available on www.luminis.com.

For options details and specifications, please refer to pages 115.116 & 72

Certification

Mounting / E.P.A

UL. Wet Location. E.P.A : 0.72 Max. weight: 30 lbs.

Model#	Mounting	Light source selection	Voltage	Finish	Options	
<input type="checkbox"/> SPT20	<input type="checkbox"/> ACA5 <input type="checkbox"/> ACW5 <input type="checkbox"/> APA1 <input type="checkbox"/> APC1 <input type="checkbox"/> APS1 <input type="checkbox"/> S <input type="checkbox"/> T <input type="checkbox"/> W	<input type="checkbox"/> MH (ED17) <input type="checkbox"/> M70 <input type="checkbox"/> M100 <input type="checkbox"/> M150 <input type="checkbox"/> M175 <input type="checkbox"/> HPS (ED17) <input type="checkbox"/> H70 <input type="checkbox"/> H100 <input type="checkbox"/> H150 (Lamps by others)	<input type="checkbox"/> CF (Gx24q) <input type="checkbox"/> Single lamp <input type="checkbox"/> F157 <input type="checkbox"/> F170	120 V Standard factory prewired (If no voltage is specified) For other voltages, please specify with catalog number. <input type="checkbox"/> H.I.D. <input type="checkbox"/> 208 V <input type="checkbox"/> 240 V <input type="checkbox"/> 277 V <input type="checkbox"/> 347 V <input type="checkbox"/> 480 V <input type="checkbox"/> COMP. FLUO. Smart ballast 120/277 <input type="checkbox"/> 347 V (To specify)	Standard selection <input type="checkbox"/> WHT: Snow white <input type="checkbox"/> BKT: Jet black <input type="checkbox"/> BZT: Bronze <input type="checkbox"/> GRT: Titanium gray <input type="checkbox"/> DGT: Gun metal <input type="checkbox"/> CHT: Champagne <input type="checkbox"/> MST: Matte silver <input type="checkbox"/> GNT: Forest green Optional colors <input type="checkbox"/> CS: Custom color <input type="checkbox"/> RAL: RAL# color	<input type="checkbox"/> R5: Type V light distribution semi specular aluminum reflector. <input type="checkbox"/> FS: Fuse <input type="checkbox"/> PH1: 120/277V photo cell <input type="checkbox"/> PH2: 347V photo cell Electrical

luminaires may be altered for design improvements or discontinued without prior notice.

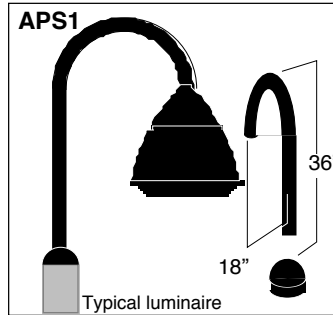
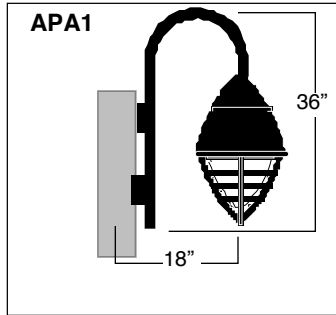
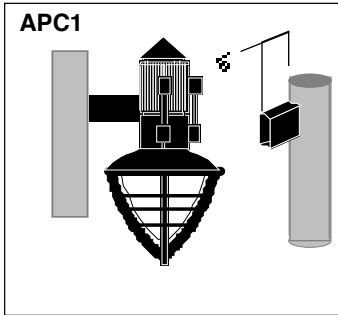

General note:
SPT20-SPT25 and SPT50 are designed as luminaire modules adaptable to various installation requirements as a pole ceiling or wall mount. Please specify the selected type of attachment with model number. (Refer to page 116 for additional pole mounting information.)

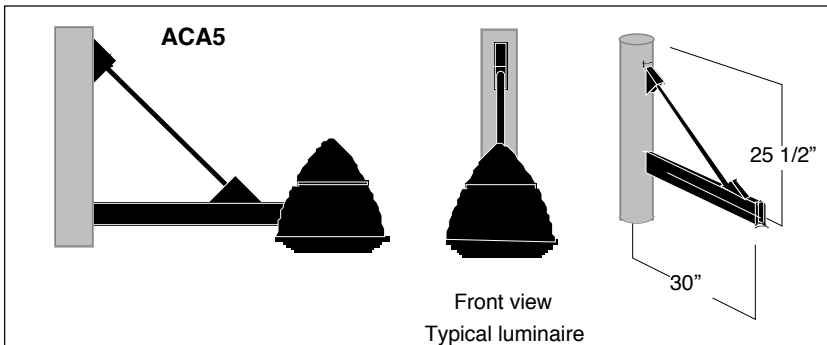
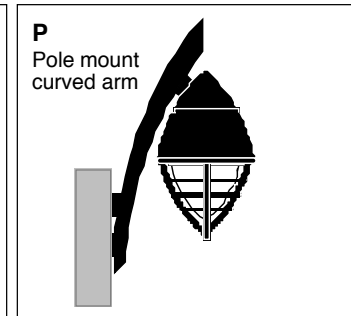
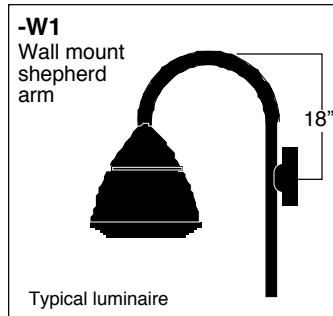
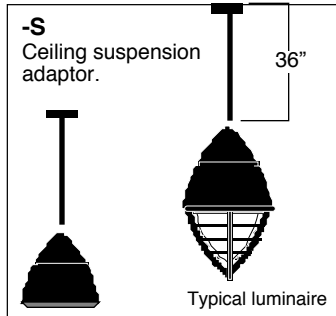
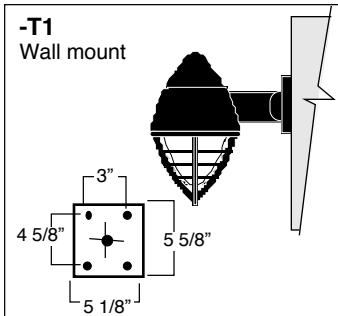

ACA5 -EPA: 0.8
1" X 3" extruded aluminum side pole arm mount. 4" O.D X 30" lg. post top adaptor with a cast aluminum tenon to fit with a 3 3/4" I.D. pole. 1/2" dia. stainless steel rod support. Extruded arm and all other parts are painted same color as Luminaire.

ACW5- Wall mount version with independent cast aluminum mounting plates.

APC1 -EPA: 0.12
1" X 3" extruded aluminum side pole mounting adaptor.

APA1 - EPA: 0.2
1 5/8" dia. aluminum shepherd style arm, with two extruded 1"X 3" aluminum side pole adaptor.

APS1 - EPA: 0.15
1 5/8" dia. aluminum shepherd style arm, with two extruded 1"X 3" aluminum pole adaptor.

-S
15° swivel ceiling mount with 5/8" dia.X36"lg aluminum stem. luminaire top adaptor allowing to cut stem to length on site.
(Mounts over a standard 4" octagonal box with 3 1/2" C/C holes)

-T1 -1" x 3" extruded aluminum wall mounting straight adaptor with cast aluminum cover and galvanized steel mounting plate.

-W1 -1 5/8" Dia. shepherd aluminum arm wall mount, with a cast aluminum wall cover and galvanized steel mounting plate.

-P - Cast aluminum elliptical curved arm. Refer to corresponding luminaire specification sheet SPT20 & SPT25 for details.

BI-LEVEL MOUNTING

Option: BL
Twin mount off set luminaire installation.

(P) Position: 180°

(P) Position: 90°

Step1:
Select distance between luminaires as shown("X")
1) BL ("X")

Step2:
Indicate position of luminaires at 90° or 180°
2) (P)-Position

EX: SPT20-BL36-90

Important: consider Additional pole length required for BL set mounting.

Spartacus SPT20 and SPT25 series may be installed in several positions along the pole. Please provide information with desired position as shown above.

luminaires may be altered for design improvements or discontinued without prior notice.

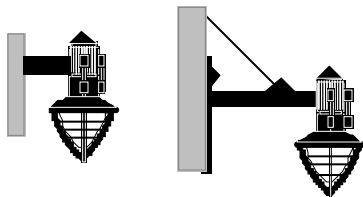
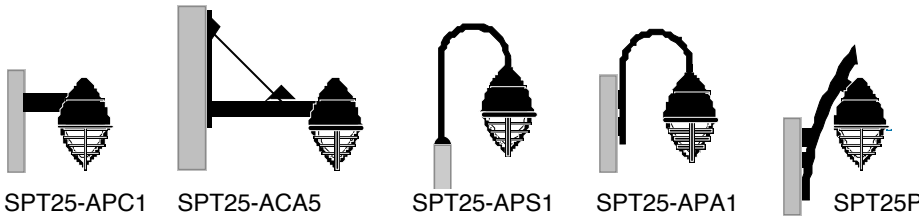
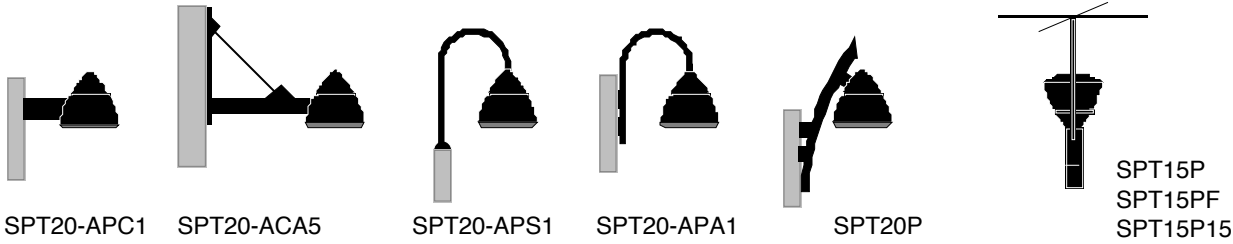

SPT50-APC1 SPT50-ACA5

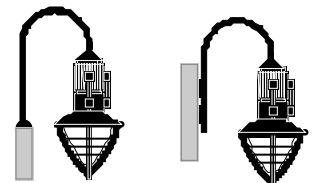

SPT50-APS1 SPT50-APA1

* Note:
36" extension with ACA5 attachment
24" extension with APA1 & APC1 attachment

Mounting style



-APA1 Mounting



-APC1 Mounting

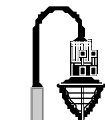

-APS1 Mounting

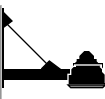

-ACA5 Mounting

PEX pole style
PXD pole style
PCA pole style
PCA pole style
PAA pole style

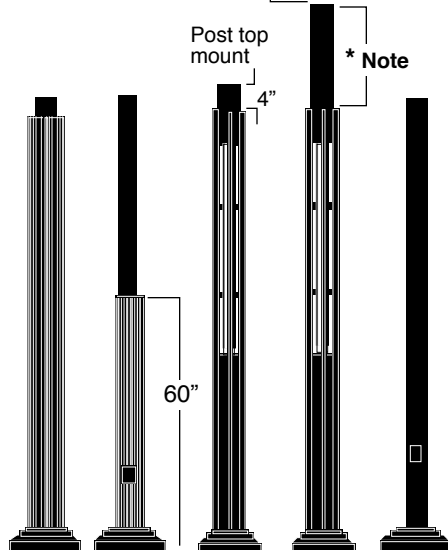

Compatible poles listing.

Post side mount with APA1 attachment accessory

4" O.D.	5" O.D.	4" O.D.	4" O.D.	Pole height
PAA410-APA	PAA510-APA		PXD10-APA	10 ft
PAA412-APA	PAA512-APA	PCA12-APA	PXD12-APA	12 ft
PAA414-APA	PAA514-APA	PCA14-APA	PXD14-APA	14 ft
PAA416-APA	PAA516-APA	PCA16-APA	PXD16-APA	16 ft
PAA418-APA	PAA518-APA		PXD18-APA	18 ft
PAA420-APA	PAA520-APA		PXD20-APA	20 ft

Post side mount with APC1 attachment accessory

PAA410-APC	PAA510-APC		PXD10-APC	10 ft
PAA412-APC	PAA512-APC	PCA12-APC	PXD12-APC	12 ft
PAA414-APC	PAA514-APC	PCA14-APC	PXD14-APC	14 ft
PAA416-APC	PAA516-APC	PCA16-APC	PXD16-APC	16 ft
PAA418-APC	PAA518-APC		PXD18-APC	18 ft
PAA420-APC	PAA520-APC		PXD20-APC	20 ft

Post top mount with APS1 attachment accessory

PAA410-A	PAA510-A1	PCA10-A	PXD10-A	10 ft
PAA412-A	PAA512-A1	PCA12-A	PXD12-A	12 ft
PAA414-A	PAA514-A1	PCA14-A	PXD14-A	14 ft
PAA416-A	PAA516-A1	PCA16-A	PXD16-A	16 ft
PAA418-A	PAA518-A1		PXD18-A	18 ft
PAA420-A	PAA520-A1		PXD20-A	20 ft

Post side mount with ACA5 attachment accessory

PAA414-ACA	PAA514-ACA	PCA14-ACA	PXD14-ACA	14 ft
PAA416-ACA	PAA516-ACA	PCA16-ACA	PXD16-ACA	16 ft
PAA418-ACA	PAA518-ACA		PXD18-ACA	18 ft
PAA420-ACA	PAA520-ACA		PXD20-ACA	20 ft

Post top mount

PAA410-A	PAA510-A2		PXD10-A	10 ft
PAA412-A	PAA512-A2		PXD12-A	12 ft
PAA414-A	PAA514-A2	PCA14-A	PXD14-A	14 ft
PAA416-A	PAA516-A2	PCA16-A	PXD16-A	16 ft
PAA418-A	PAA518-A2		PXD18-A	18 ft
PAA420-A	PAA520-A2		PXD20-A	20 ft

For poles details and specification, please refer to pages 140 to 144

Luminaires may be altered for design improvements or discontinued without prior notice.