

SMAG Plastic-Encapsulate Diodes

Schottky Rectifier

Features

- I_o 5A
- V_{RRM} 20V-200V
- High surge current capability
- Polarity: Color band denotes cathode

Applications

- Rectifier

Marking

- SS5X
- X : From 2 To 20

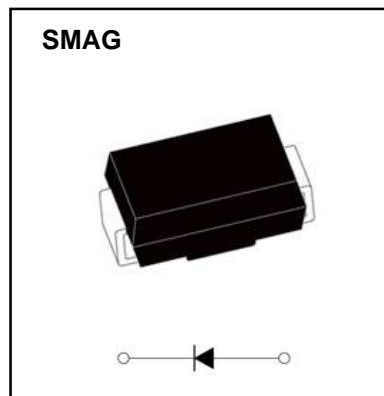

Limiting Values (Absolute Maximum Rating)

Item	Symbol	Unit	Test Conditions	SS5																
				2	3	4	5	6	8	10	15	20								
Repetitive Peak Reverse Voltage	V_{RRM}	V		20	30	40	50	60	80	100	150	200								
Maximum RMS Voltage	V_{RMS}	V		14	21	28	35	42	56	70	105	140								
Average Forward Current	$I_{F(AV)}$	A	60HZ Half-sine wave, Resistance load, TL(Fig.1)	5.0																
Surge(Non-repetitive)Forward Current	I_{FSM}	A	60Hz Half-sine wave , 1 cycle , $T_a=25^{\circ}C$	150																
Junction Temperature	T_J	$^{\circ}C$		-65~+125					-65~+150											
Storage Temperature	T_{STG}	$^{\circ}C$		-65 ~ +150																

Electrical Characteristics ($T_a=25^{\circ}C$ Unless otherwise specified)

Item	Symbol	Unit	Test Condition	SS5									
				2	3	4	5	6	8	10	15	20	
Peak Forward Voltage	V_F	V	$I_F=5.0A$	0.55			0.7		0.85		0.95		
Peak Reverse Current	I_{RRM1}	mA	$V_{RM}=V_{RRM}$	$T_a=25^{\circ}C$			0.5		0.1				
	I_{RRM2}			$T_a=100^{\circ}C$			10		0.5				
Thermal Resistance(Typical)	$R_{\theta J-A}$	$^{\circ}C/W$	Between junction and ambient	55 ¹⁾									
	$R_{\theta J-L}$		Between junction and terminal	17 ¹⁾									

Notes:

Thermal resistance from junction to ambient and from junction to lead mounted on P.C.B. with 0.2" x 0.2" (5.0 mm x 5.0 mm) copper pad areas

Typical Characteristics

FIG.1: FORWARD CURRENT DERATING CURVE

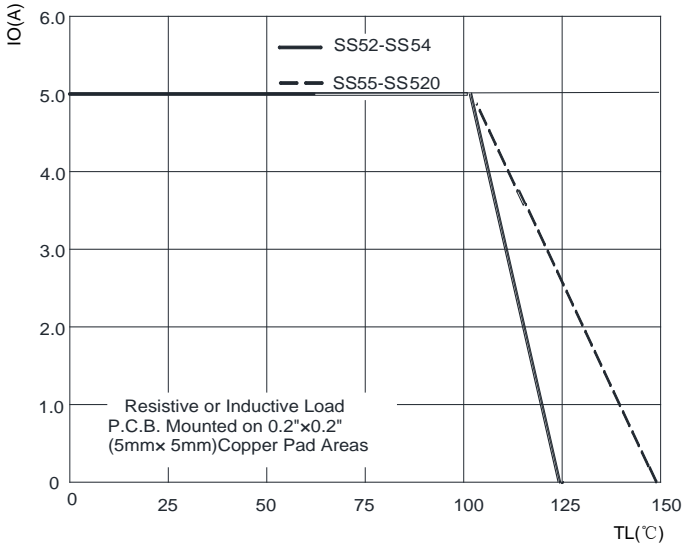

FIG.2: MAXIMUM NON-REPETITIVE FORWARD URGE CURRENT

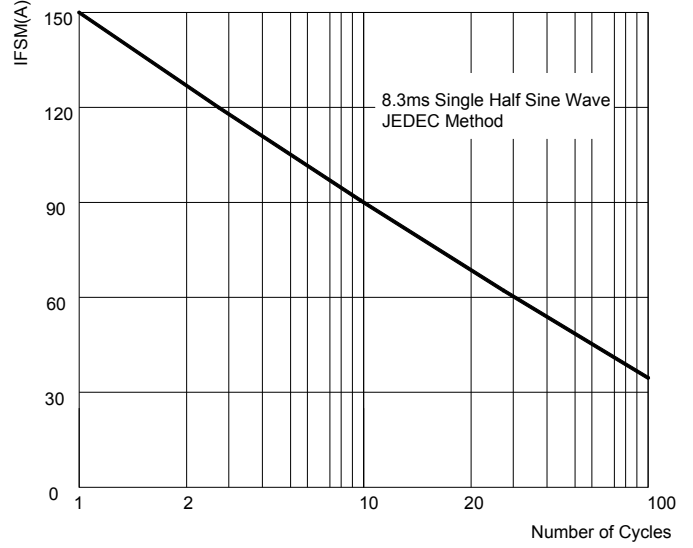

FIG.3: TYPICAL FORWARD CHARACTERISTICS

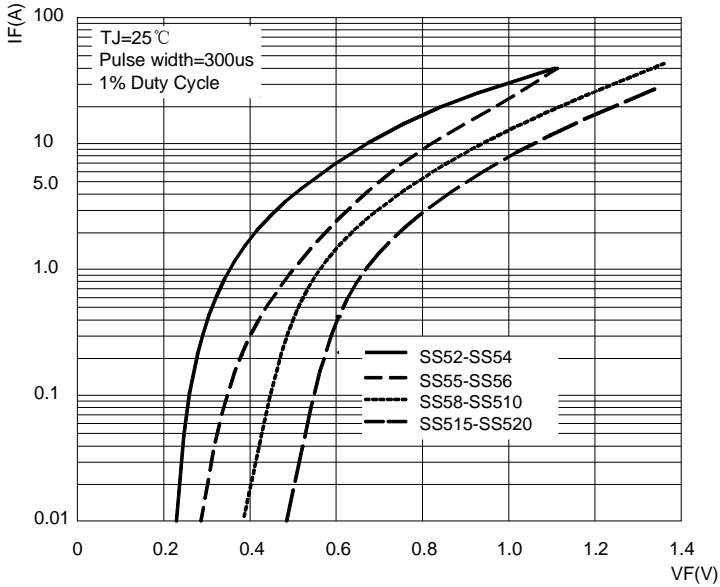
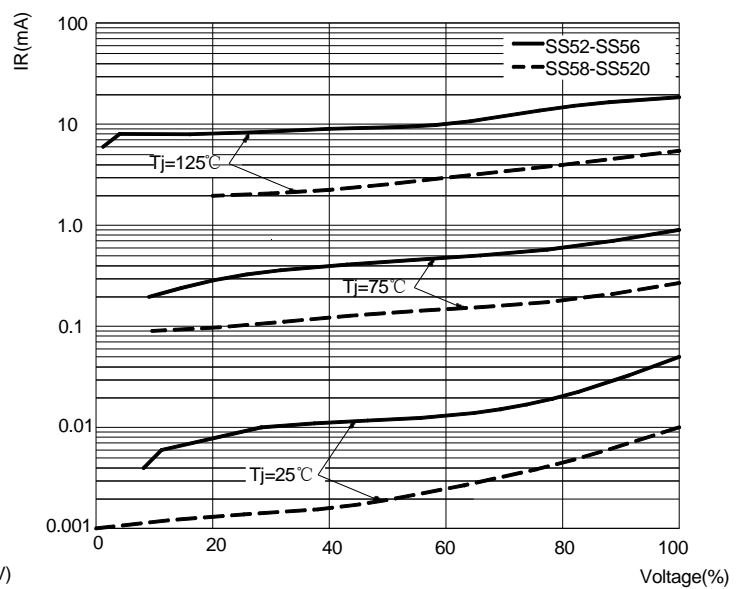
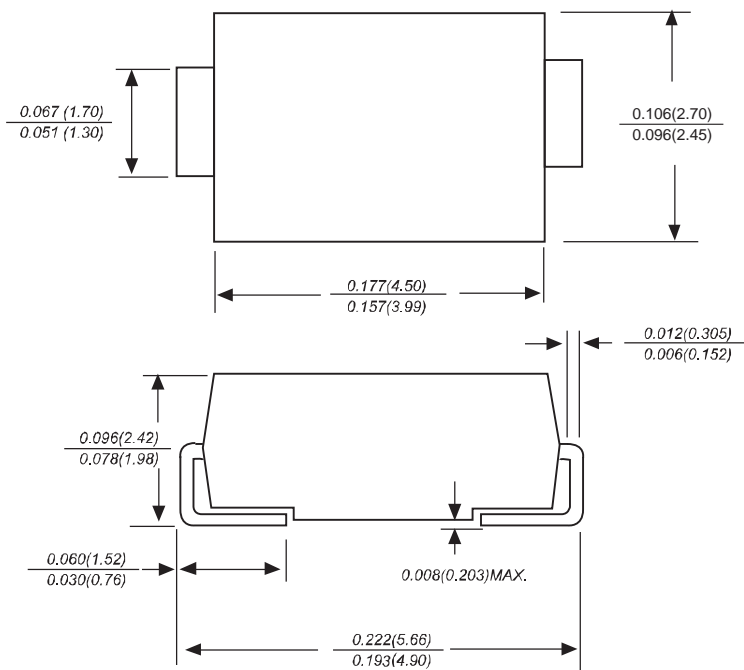

FIG.4: TYPICAL REVERSE CHARACTERISTICS



SMAG Package Outline Dimensions



Dimensions in inches and (millimeters)

SMAG Suggested Pad Layout

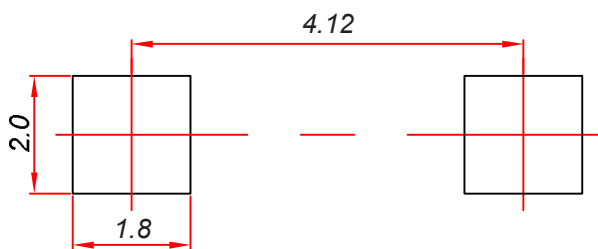

Note:

1. Controlling dimension: in millimeters.
2. General tolerance: ± 0.05 mm.
3. The pad layout is for reference purposes only.

NOTICE

JSHD reserve the right to make modifications, enhancements, improvements, corrections or other changes without further notice to any product herein. JSHD does not assume any liability arising out of the application or use of any product described herein.

Reel Taping Specifications For Surface Mount Devices- SMAG

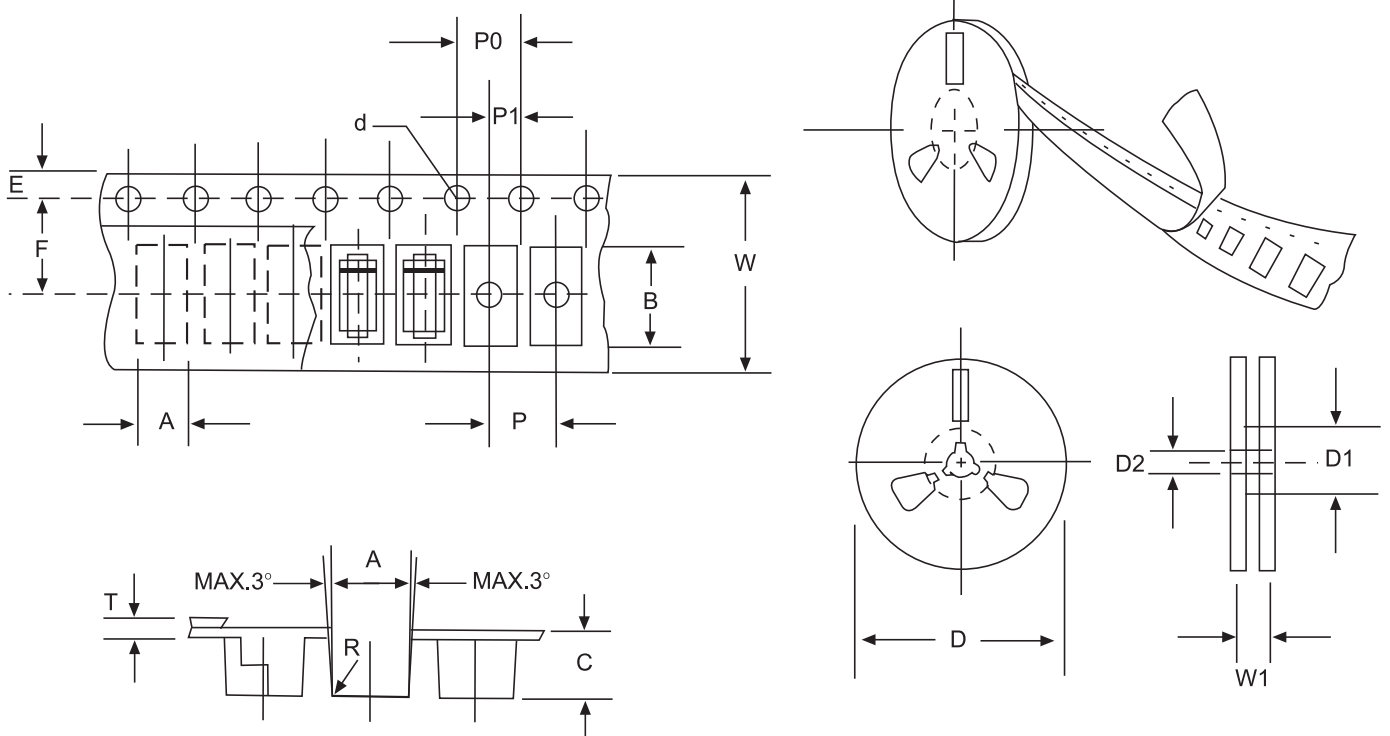

Fig:CONFIGURATION OF FLAT MELF TAPING

ITEM	SYMBOL	SMAG mm(inch)
Carrier width	A	2.79±0.1(0.110±0.004)
Carrier length	B	5.33±0.1(0.210±0.004)
Carrier depth	C	2.36±0.1(0.093±0.004)
Sprocket hole	d	1.55±0.05(0.061±0.002)
Reel outside diameter	D	279±2.0 (11± 0.079)
Reel inner diameter	D1	75±1.0 (2.95 ±0.039)
Feed hole diameter	D2	13±0.5(0.512±0.020)
Sprocket hole position	E	1.75±0.1(0.069±0.004)
Punch hole position	F	5.5±0.05(0.217±0.002)
Punch hole pitch	P	4.0±0.1(0.157±0.004)
Sprocket hole pitch	P0	4.0±0.1(0.157±0.004)
Embossment center	P1	2.0±0.1(0.079±0.004)
Totall tape thickness	T	0.28±0.02(0.011 ±0.0008)
Tape width	W	12.0±0.2(0.472±0.008)
Reel width	W1	16.8±2.0(0.661±0.079)

NOTE:Devices are packde in accordance with EIA standard RS-481-A and specification given above.