



# LED-25W Series– Fixed Output and Dimmable Switch Mode LED Drivers Constant Current & Constant Voltage with Isolation Black Magic Thermal Advantage™ Plastic Housing

## Electrical Specifications

Input Voltage Range:	100-277 Vac Nom. (90-305 V Min/Max)
Input Over-Voltage:	Can endure 320Vac for 48 Hrs, 350Vac for 2 Hrs
Frequency:	50/60 Hz Nom. (47-63 Hz Min/Max)
Power Factor:	>0.90 @ full load, 100V through 277V
Inrush Current:	<15.0 Amps max @ 230 Vac, cold start 25°C
Input Current:	0.25 Amps max @ 120 Vac
Maximum Power:	25W
Current Accuracy:	± 1% Over input line variation
Load Regulation:	± 3%
THD:	≤ 20% @ full load
Leakage Current:	400 µA Typical
Hold Up Time:	Half Cycle
Protection:	Output Over-Voltage, Output Over-Current, and Output Short Circuit Protection with Auto Recovery

## Environmental Specifications

Minimum Starting Temp:	-30°C
Maximum Case Temp.	90°C
Storage Temperature:	-40°C to +85°C
Humidity:	5% to 95%
Cooling:	Convection
Vibration Frequency:	5 to 55 Hz/2g, 30 minutes
Sound Rating:	Class A
MTBF:	482,000 Hours at full load and 40°C ambient conditions per MIL-217F Notice 2
EMC:	FCC 47CFR Part 15 Class B compliant



- Total Power: 25 Watts
- Input Voltage: 100-277 Vac Nom.
- UL Dry & Damp Location Rated
- High Power Factor
- UL8750 and Class 2 Compliant, as noted
- UL Sign Components Manual (S.A.M. Models)

Constant Current				
Model Number	Output Current (mA ±3%)	Output Voltage Range (Vdc)	Max. Output Power (W)	Typical Efficiency
LED25W-72-C0350-XX	350	24-72	25	86%
LED25W-40-C0350-XX	350	13-40	14	84%
LED25W-28-C0350-XX	350	10-28	9.8	83%
LED25W-62-C0400-XX	400	21-62	24.8	85%
LED25W-56-C0450-XX	450	19-56	25	84%
LED25W-40-C0500-XX	500	13-40	20	84%
LED25W-40-C0620-XX	620	13-40	24.8	84%
LED25W-36-C0700-XX	700	12-36	25	84%
LED25W-28-C0850-XX	850	10-28	23.8	83%
LED25W-24-C1040-XX	1040	8-24	25	83%
LED25W-20-C1250-XX	1250	7-20	25	83%
LED25W-18-C1400-XX	1400	6-18	25	82%
LED25W-16-C1560-XX	1560	6-16	25	82%
LED25W-14-C1750-XX	1750	5-14	24.5	82%
LED25W-12-C2080-XX	2080	4-12	25	81%

-XX indicates dimming options are available. See options at left. Blank = fixed current output

Constant Voltage				
Model Number	Output Voltage (Vdc ±5%)	Output Current Range (mA)	Max. Output Power (W)	Typical Efficiency
LED25W-12	12	520-2080	25	81%
LED25W-14	14	438-1750	24.5	82%
LED25W-16	16	390-1560	25	82%
LED25W-18	18	360-1400	25	82%
LED25W-20	20	313-1250	25	83%
LED25W-24	24	260-1040	25	83%
LED25W-28	28	213-850	23.8	83%
LED25W-36	36	175-700	25	84%
LED25W-40	40	155-620	24.8	84%
LED25W-56	56	113-450	25	84%
LED25W-62	62	100-400	24.8	85%
LED25W-72	72	88-350	25	86%

• Indicates S.A.M.

### Ordering Options:

- D: 0-10V & Resistance dimmable version comes with an extra two wires +Purple/-Gray on the output side. "-D" 0-10V Dimming is compatible with most quality 0-10V wall dimmers. See page 3 for additional specifications.
- PD: PWM Dimmable version comes with an extra two wires +Purple/-Gray on the output side. "-PD" version is PWM Dimmable via a positive 10% to 100% Duty Cycle, 200Hz to 1KHz, 0-10V Pulse. See page 4 for additional specifications.



**Note:**  
LED drivers are designed and intended to operate LED loads only. Non-LED loading may be outside the specified design limits of our LED drivers, and therefore cannot be covered by any warranty. If you desire to use our LED drivers to operate non-LED loads please contact us to discuss compatibility.

Specifications subject to change without notice.

Class 2: US/Canada US Only

Rev 9-11-15

**Dimensions - IN [mm]**

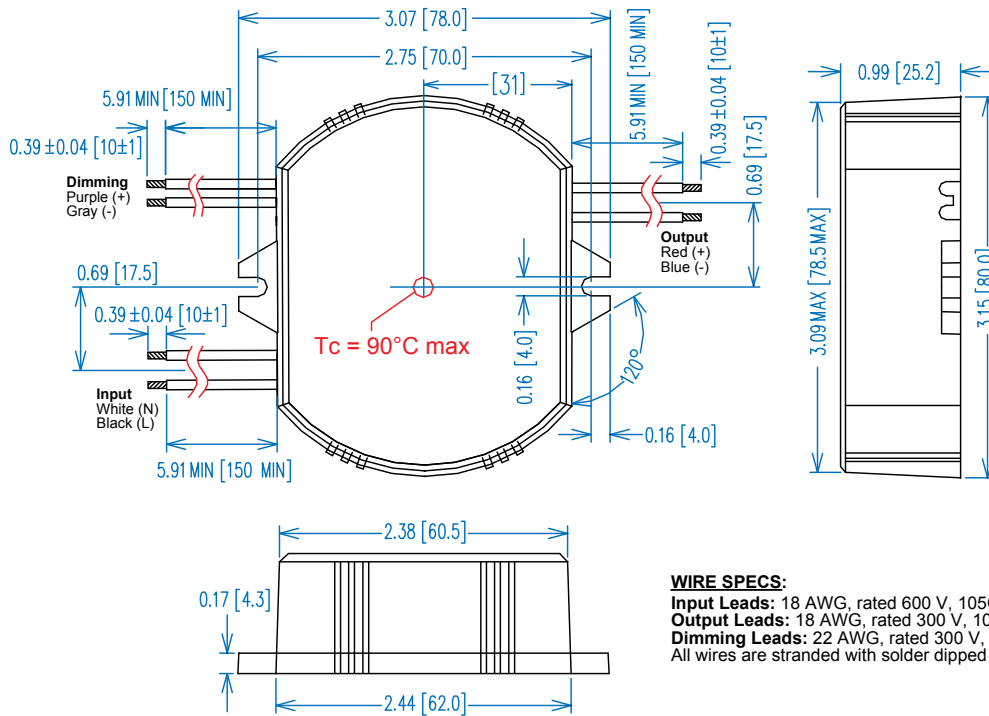

**WIRE SPECS:**

**Input Leads:** 18 AWG, rated 600 V, 105C, min.  
**Output Leads:** 18 AWG, rated 300 V, 105C, min.  
**Dimming Leads:** 22 AWG, rated 300 V, 105C.  
 All wires are stranded with solder dipped ends.

**Power Factor / Load**

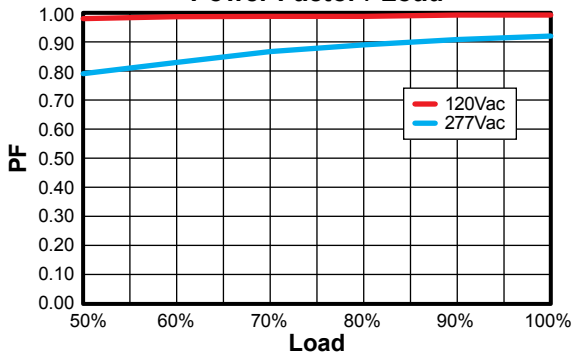

**THD / Load**

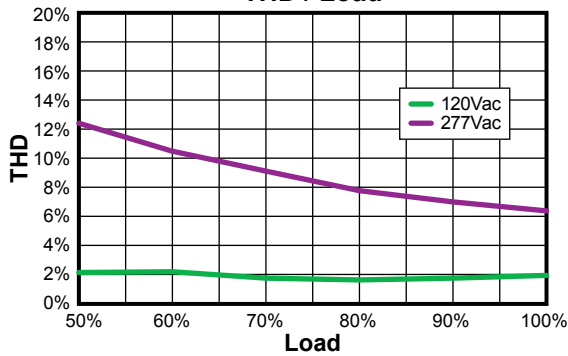

**Typical Efficiency / Load**

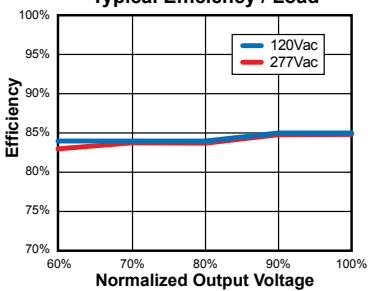

**Lifetime / Case Temperature**

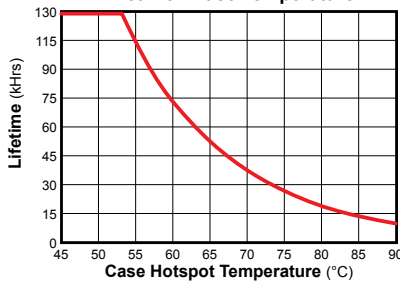

**Safety and EMC Compliance**

UL/CUL	UL8750, CSA-C22.2
C E	EN 61347
FCC, 47CFR Part 15	Class B
EN61000-3-2	
EN61000-3-3	Class C
EN61000-4-5	2kV

**UL Conditions of Acceptability**

See website for additional information

**Note:**

Life calculations are based on reliability with confidence using a 90% confidence level and <5% failure rate. At a confidence level of 90% it is expected that <5% of the parts will fail at the rated life provided. (Failure is defined as a driver drifting outside specification, rather than fail to operate)

**“-D” Option: 0-10VDC and Resistance Dimming**

Parameters	Minimum	Typical	Maximum
Source Current out of 0-10V Purple Wire	0 mA	—	2 mA
Absolute Voltage Range on 0-10V (+) Purple Wire	-2.0 V	—	+15 V

**Typical Dimming Circuit**

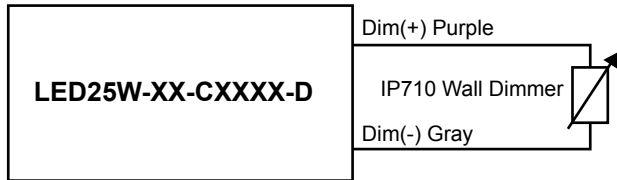

(Dimmer must be current-sink type control)

**Output Current / 0-10VDC Dimming Control Voltage**

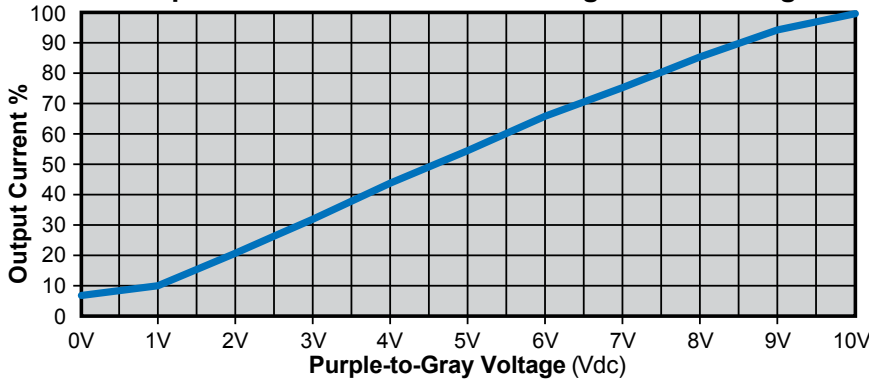

**Notes:**

1. 0-10V dimmable version comes with an extra two wires +Purple/-Gray on the output side.
2. Compatible with most 0-10V dimmers. Recommended dimmer is Leviton IP710 or equivalent
3. 0-10V dimmable version is not intended to dim below about 5% @ 0V or 10% @ 1.0V
4. 0-10V dimmable version output will be 100% with Purple/Gray open and minimum with Purple/Gray Shorted.

**“-PD” Option: PWM Dimming**

Parameters	Minimum	Typical	Maximum
Absolute Maximum Voltage Range on PWM Input (Purple Wire)	-2.0V	10V	+28V
Input LOW Level Voltage Range (Purple Wire)	-2.0	0V	+7.5V
Input HIGH Level Voltage Range (Purple Wire)	+9.0	10V	28V
Sink Current into PWM Input (Purple Wire)	0mA	—	1.2mA
PWM Input Signal Frequency	200Hz	—	1000Hz
PWM Input Signal Positive Duty Cycle	0%	10-90%	100%

**PWM Positive Dimming Typical Circuit**

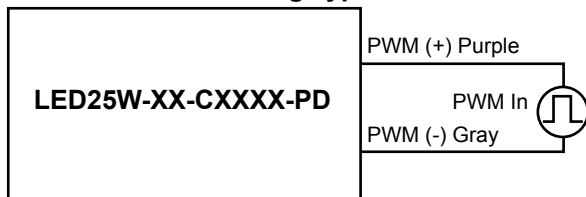

**Output Current / Positive Duty Cycle**

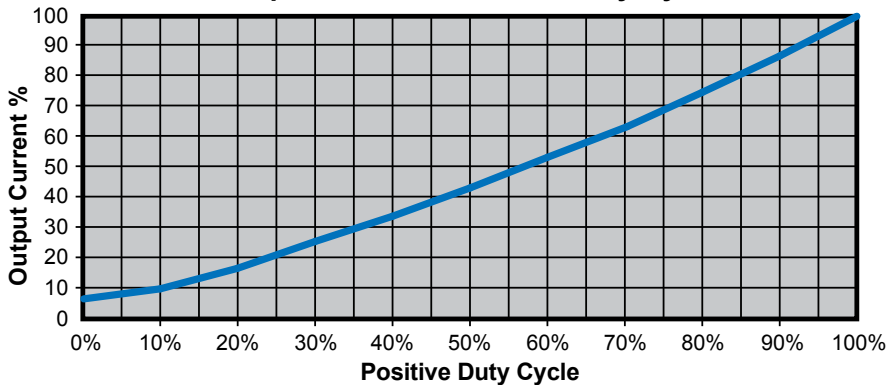

**Notes:**

1. PWM Dimmable version comes with an extra 2 wires +Purple/-Gray on the output side.
2. Below 10% Duty cycle proper dimming operation is not assured. Unit is not intended to turn off at <10% Duty Cycle.
3. PWM dimmable version output will be 100% with Purple/Gray open and minimum with Purple/Gray Shorted.