

SMCG-HR Series



Agency Approvals

AGENCY	AGENCY FILE NUMBER
	E230531

Maximum Ratings and Thermal Characteristics ($T_A=25^\circ\text{C}$ unless otherwise noted)

Parameter	Symbol	Value	Unit
Peak Pulse Power Dissipation at $T_A=25^\circ\text{C}$ by 10/1000 μs waveform (Fig.2)(Note 1), (Note 2)	P_{PPM}	1500	W
Power Dissipation on infinite heat sink at $T_A=50^\circ\text{C}$	$P_{M(AV)}$	6.5	W
Peak Forward Surge Current, 8.3ms Single Half Sine Wave (Note 3)	I_{FSM}	200	A
Maximum Instantaneous Forward Voltage at 100A for Unidirectional only	V_F	3.5	V
Operating Junction and Storage Temperature Range	T_J, T_{STG}	-65 to 150	$^\circ\text{C}$
Typical Thermal Resistance Junction to Lead	R_{wJL}	15	$^\circ\text{C/W}$
Typical Thermal Resistance Junction to Ambient	R_{wJA}	75	$^\circ\text{C/W}$

Notes:

1. Non-repetitive current pulse, per Fig. 4 and derated above $T_A = 25^\circ\text{C}$ per Fig. 3.
2. Mounted on copper pad area of 0.31x0.31" (8.0 x 8.0mm) to each terminal.
3. Measured on 8.3ms single half sine wave or equivalent square wave for unidirectional device only, duty cycle=4 per minute maximum.

Functional Diagram

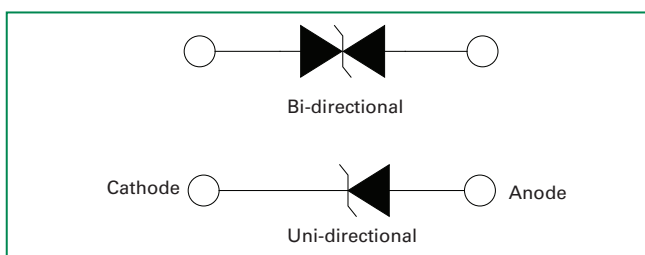

Description

The SMCG-HR series is designed specifically to protect sensitive electronic equipment from voltage transients induced by lightning and other transient voltage events.

Features

- High-Reliability up-screened for critical applications require higher reliability performance and low infant mortality failures.
- Excellent clamping capability
- Low incremental surge resistance
- Typical I_R less than $1\mu\text{A}$ above 12V
- For surface mounted applications to optimize board space
- L bend lead forming gives best solderability for Hi reliability application
- Typical failure mode is short from over-specified voltage or current
- Whisker test is conducted based on JEDEC JESD201A per its table 4a and 4c
- IEC-61000-4-2 ESD 15kV(Air), 8kV (Contact)
- ESD protection of data lines in accordance with IEC 61000-4-2 (IEC801-2)
- EFT protection of data lines in accordance with IEC 61000-4-4 (IEC801-4)
- Built-in strain relief
- Fast response time: typically less than 1.0ps from 0V to BV min
- 1500W peak pulse power capability at 10/1000 μs waveform, repetition rate (duty cycles):0.01%
- $V_{BR} @T_J = V_{BR} @25^\circ\text{C} \times (1 + \alpha T \times (T_J - 25))$ (α T:Temperature Coefficient, typical value is 0.1%)
- Glass passivated chip junction
- High temperature soldering guaranteed: 260 $^\circ\text{C}$ /10 seconds at terminals
- Meet MSL level1, per J-STD-020, LF maximum peak of 260 $^\circ\text{C}$
- Matte tin lead-free plated
- Halogen free
- RoHS compliant with exemption 7a and 7c-I
- 2nd level interconnect is Pb-free per IPC/JEDEC J-STD-609A.01

Applications

TVS devices are ideal for the protection of I/O Interfaces, V_{CC} bus and other vulnerable circuits used in Telecom, Computer, Industrial and Consumer electronic applications.

Electrical Characteristics

Part Number (Uni)	Part Number (Bi)	Marking		Reverse Stand off Voltage V_R (Volts)	Breakdown Voltage V_{BR} (Volts) @ I_T		Test Current I_T (mA)	Maximum Clamping Voltage V_C @ I_{pp} (V)	Maximum Peak Pulse Current I_{pp} (A)	Maximum Reverse Leakage I_R @ V_R (μ A)	Agency Approval 
		UNI	BI		MIN	MAX					
SMCG5.0A-HR	SMCG5.0CA-HR	GDE	BDE	5.0	6.40	7.00	10	9.2	163.0	800	X
SMCG6.0A-HR	SMCG6.0CA-HR	GDG	BDG	6.0	6.67	7.37	10	10.3	145.7	800	X
SMCG6.5A-HR	SMCG6.5CA-HR	GDK	BDK	6.5	7.22	7.98	10	11.2	134.0	500	X
SMCG7.0A-HR	SMCG7.0CA-HR	GDM	BDM	7.0	7.78	8.60	10	12.0	125.0	200	X
SMCG7.5A-HR	SMCG7.5CA-HR	GDP	BDP	7.5	8.33	9.21	1	12.9	116.3	100	X
SMCG8.0A-HR	SMCG8.0CA-HR	GDR	BDR	8.0	8.89	9.83	1	13.6	110.3	50	X
SMCG8.5A-HR	SMCG8.5CA-HR	GDT	BDT	8.5	9.44	10.40	1	14.4	104.2	20	X
SMCG9.0A-HR	SMCG9.0CA-HR	GDV	BDV	9.0	10.00	11.10	1	15.4	97.4	10	X
SMCG10A-HR	SMCG10CA-HR	GDX	BDX	10.0	11.10	12.30	1	17.0	88.3	5	X
SMCG11A-HR	SMCG11CA-HR	GDZ	BDZ	11.0	12.20	13.50	1	18.2	82.5	1	X
SMCG12A-HR	SMCG12CA-HR	GEE	BEE	12.0	13.30	14.70	1	19.9	75.4	1	X
SMCG13A-HR	SMCG13CA-HR	GEG	BEG	13.0	14.40	15.90	1	21.5	69.8	1	X
SMCG14A-HR	SMCG14CA-HR	GEK	BEK	14.0	15.60	17.20	1	23.2	64.7	1	X
SMCG15A-HR	SMCG15CA-HR	GEM	BEM	15.0	16.70	18.50	1	24.4	61.5	1	X
SMCG16A-HR	SMCG16CA-HR	GEP	BEP	16.0	17.80	19.70	1	26.0	57.7	1	X
SMCG17A-HR	SMCG17CA-HR	GER	BER	17.0	18.90	20.90	1	27.6	54.4	1	X
SMCG18A-HR	SMCG18CA-HR	GET	BET	18.0	20.00	22.10	1	29.2	51.4	1	X
SMCG20A-HR	SMCG20CA-HR	GEV	BEV	20.0	22.20	24.50	1	32.4	46.3	1	X
SMCG22A-HR	SMCG22CA-HR	GEX	BEX	22.0	24.40	26.90	1	35.5	42.3	1	X
SMCG24A-HR	SMCG24CA-HR	GEZ	BEZ	24.0	26.70	29.50	1	38.9	38.6	1	X
SMCG26A-HR	SMCG26CA-HR	GFE	BEF	26.0	28.90	31.90	1	42.1	35.7	1	X
SMCG28A-HR	SMCG28CA-HR	GFG	BFG	28.0	31.10	34.40	1	45.4	33.1	1	X
SMCG30A-HR	SMCG30CA-HR	GFK	BFK	30.0	33.30	36.80	1	48.4	31.0	1	X
SMCG33A-HR	SMCG33CA-HR	GFM	BFM	33.0	36.70	40.60	1	53.3	28.2	1	X
SMCG36A-HR	SMCG36CA-HR	GFP	BFP	36.0	40.00	44.20	1	58.1	25.9	1	X
SMCG40A-HR	SMCG40CA-HR	GFR	BFR	40.0	44.40	49.10	1	64.5	23.3	1	X
SMCG43A-HR	SMCG43CA-HR	GFT	BFT	43.0	47.80	52.80	1	69.4	21.7	1	X
SMCG45A-HR	SMCG45CA-HR	GFV	BFV	45.0	50.00	55.30	1	72.7	20.6	1	X
SMCG48A-HR	SMCG48CA-HR	GFX	BFX	48.0	53.30	58.90	1	77.4	19.4	1	X
SMCG51A-HR	SMCG51CA-HR	GFZ	BFZ	51.0	56.70	62.70	1	82.4	18.2	1	X
SMCG54A-HR	SMCG54CA-HR	GGE	BGE	54.0	60.00	66.30	1	87.1	17.3	1	X
SMCG58A-HR	SMCG58CA-HR	GGG	BGG	58.0	64.40	71.20	1	93.6	16.1	1	X
SMCG60A-HR	SMCG60CA-HR	GGK	BGK	60.0	66.70	73.70	1	96.8	15.5	1	X
SMCG64A-HR	SMCG64CA-HR	GGM	BGM	64.0	71.10	78.60	1	103.0	14.6	1	X
SMCG70A-HR	SMCG70CA-HR	GGP	BGP	70.0	77.80	86.00	1	113.0	13.3	1	X
SMCG75A-HR	SMCG75CA-HR	GGR	BGR	75.0	83.30	92.10	1	121.0	12.4	1	X
SMCG78A-HR	SMCG78CA-HR	GGT	BGT	78.0	86.70	95.80	1	126.0	11.9	1	X
SMCG85A-HR	SMCG85CA-HR	GGV	BGV	85.0	94.40	104.00	1	137.0	11.0	1	X
SMCG90A-HR	SMCG90CA-HR	GGX	BGX	90.0	100.00	111.00	1	146.0	10.3	1	X
SMCG100A-HR	SMCG100CA-HR	GGZ	BGZ	100.0	111.00	123.00	1	162.0	9.3	1	X
SMCG110A-HR	SMCG110CA-HR	GHE	BHE	110.0	122.00	135.00	1	177.0	8.5	1	X
SMCG120A-HR	SMCG120CA-HR	GHG	BHG	120.0	133.00	147.00	1	193.0	7.8	1	X

Note:

1. For bidirectional type having V_R of 10 volts and less, the I_R limit is double.

Screen Process

100% vision inspection	MIL-STD-750 method 2074
100% High Temperature Storage Life (168hrs, 175C)	MIL-STD-750 method 1031
100% X-RAY inspection	MIL-STD-750 method 2076
100% Temperature cycle test (-55-150C, 20 cycles, dwell time 15 min)	MIL-STD-750 method 1051
100% Reflow (2x)	JEDEC J-STD-020
100% surge test (2x)	MIL-STD-750 method 4066
100% HTRB(150C, Bias=VR(80% breakdown voltage), 96hrs), for Bi-direction products, 96hrs for each direction	MIL-STD-750 method 1038
Final electrical test(100% 3 sigma limit, 100% dynamic test and PAT limit)	MIL-STD-750 method 4016.4021.4011

Note: Up-screen program can be specified by customer's request via contacting Littelfuse service

Group B Test Requirement

Screen	Method	Condition	Requirement
Surge Test	10/1000 μ S Peak Pluse Waveform	Maximum Clamping Voltage (V_C) @ Peak Plus Current (I_{PP})	Sample Size 45 Perform 10x Accept 0 Failures
Burn - In (HTRB)	MIL - STD - 750, Method 1038.5	Applied Voltage 100% V_R @ 150°C	Sample Size 45 For Unidirectional, 150C/ V_R /340hours, for Bidirectional, 150C/ V_R /680hrs(340hours for each direction) Accept 0 Failures
Electrical Tests	--	I_R @ V_R , V_{BR} @ I_T	Sample Size 45 Accept 0 Failures

I-V Curve Characteristics

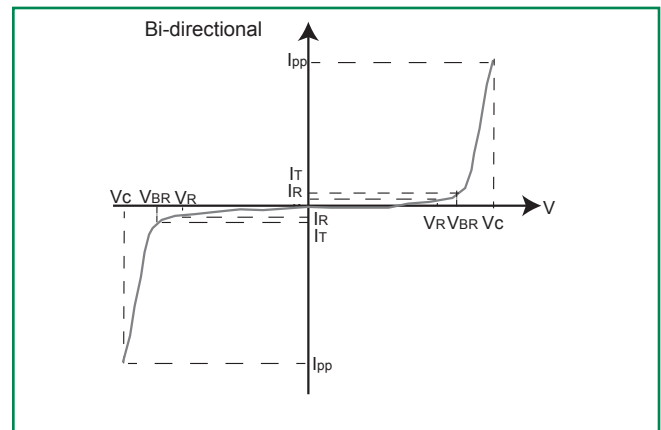
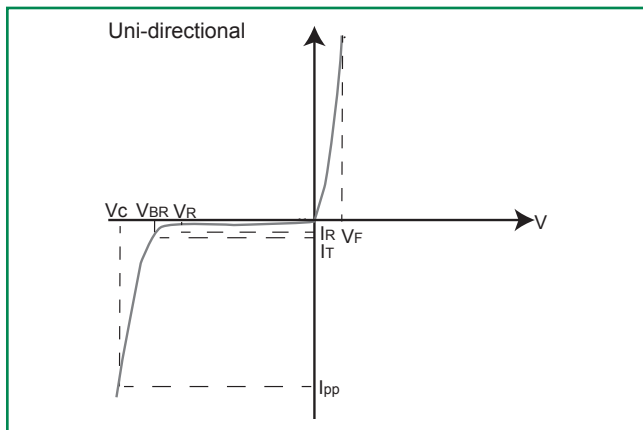

P_{PPM} Peak Pulse Power Dissipation – Max power dissipation

V_R Stand-off Voltage – Maximum voltage that can be applied to the TVS without operation

V_{BR} Breakdown Voltage – Maximum voltage that flows through the TVS at a specified test current (I_T)

V_C Clamping Voltage – Peak voltage measured across the TVS at a specified I_{PPM} (peak impulse current)

I_R Reverse Leakage Current – Current measured at V_R

V_F Forward Voltage Drop for Uni-directional

continues on next page.

Ratings and Characteristic Curves ($T_A=25^\circ\text{C}$ unless otherwise noted)

Figure 1 - TVS Transients Clamping Waveform

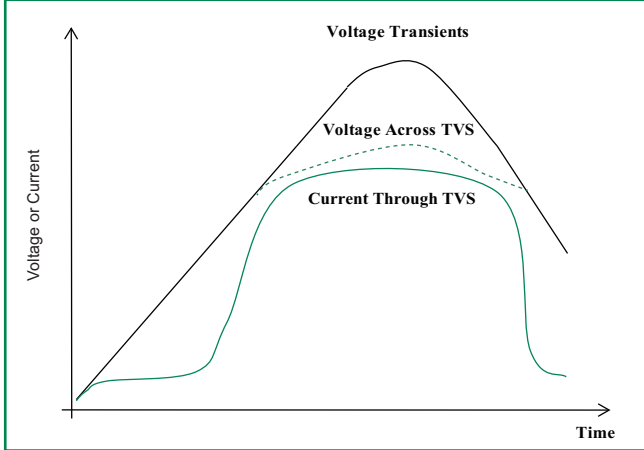

Figure 2 - Peak Pulse Power Rating

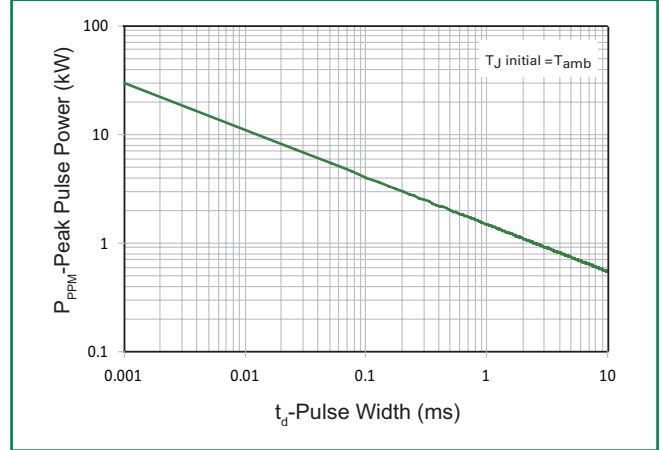

Figure 3 - Peak Pulse Power Derating Curve

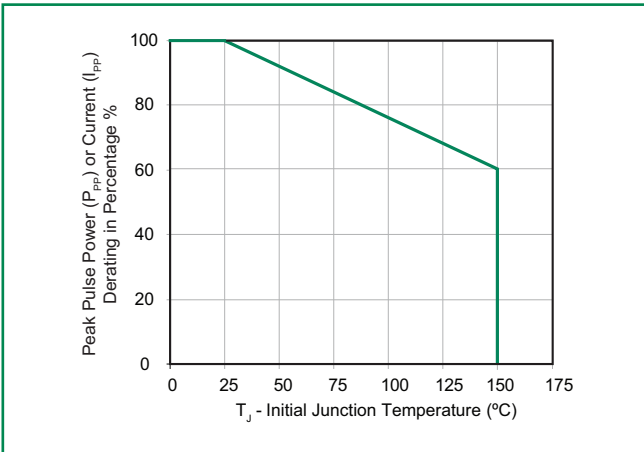

Figure 4 - Pulse Waveform

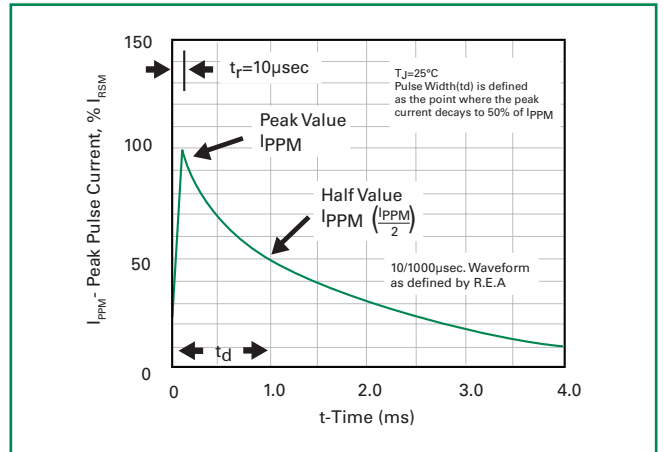

Figure 5 - Typical Junction Capacitance

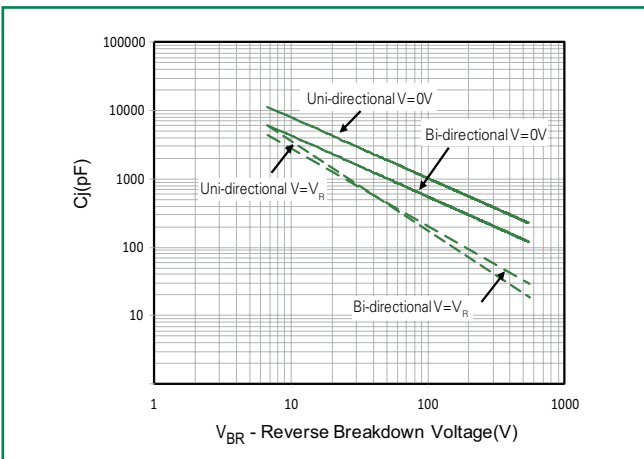

Figure 6 - Typical Transient Thermal Impedance

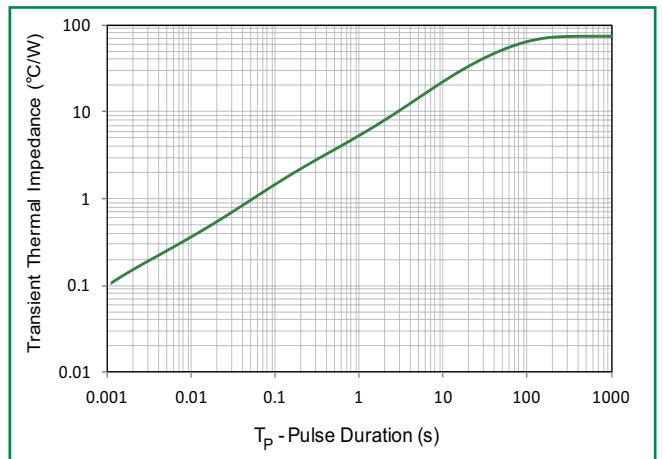
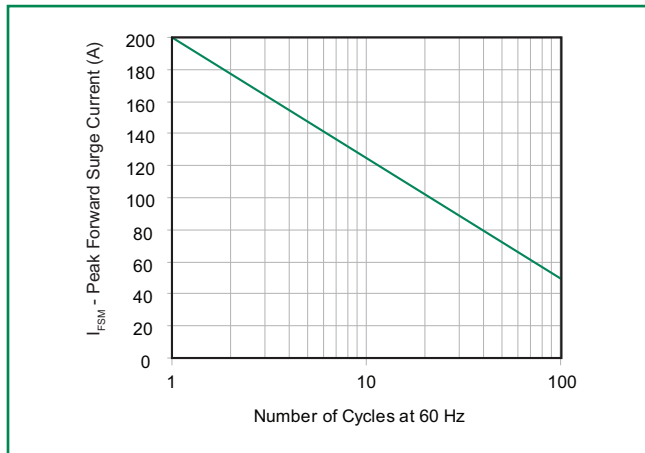
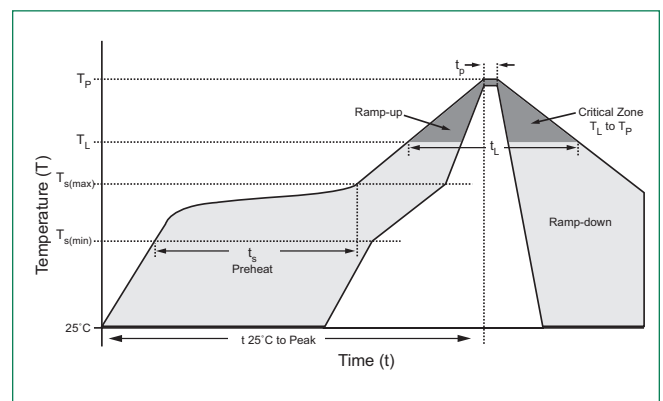

Figure 7 - Maximum Non-Repetitive Peak Forward Surge Current Uni-Directional Only



Soldering Parameters

Reflow Condition		Lead-free assembly
Pre Heat	- Temperature Min ($T_{s(min)}$)	150°C
	- Temperature Max ($T_{s(max)}$)	200°C
	- Time (min to max) (t_s)	60 – 120 secs
Average ramp up rate (Liquidus Temp (T_L) to peak)		3°C/second max
$T_{s(max)}$ to T_L - Ramp-up Rate		3°C/second max
Reflow	- Temperature (T_L) (Liquidus)	217°C
	- Time (min to max) (t_s)	60 – 150 seconds
Peak Temperature (T_p)		260 ^{+0/-5} °C
Time within 5°C of actual peak Temperature (t_p)		30 seconds
Ramp-down Rate		6°C/second max
Time 25°C to peak Temperature (T_p)		8 minutes Max.
Do not exceed		260°C



Physical Specifications

Weight	0.007 ounce, 0.21 grams
Case	JEDEC DO-215AB. Molded plastic body over glass passivated junction
Polarity	Color band denotes positive end (cathode) except Bidirectional.
Terminal	Matte Tin-plated leads, Solderable per JESD22-B102

Environmental Specifications

High Temp. Storage	JESD22-A103
HTRB	JESD22-A108
Thermal Shock	JESD22-A106
MSL	JEDEC-J-STD-020, Level 1
H3TRB	JESD22-A101
RSH	JESD22-A111

Dimensions

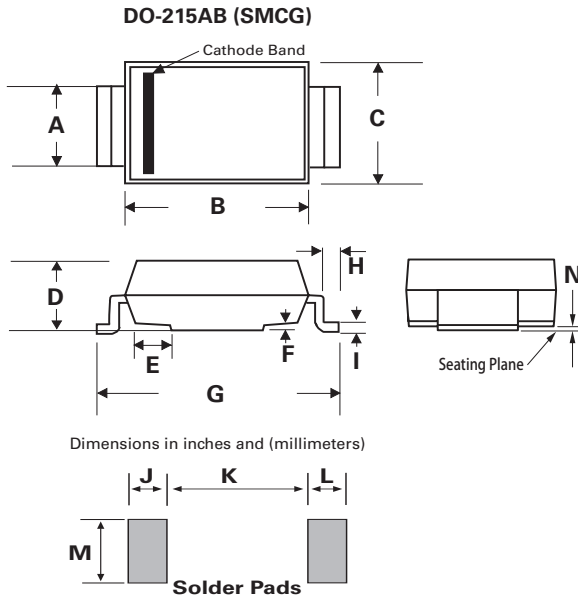

Dimensions	Inches		Millimeters	
	Min	Max	Min	Max
A	0.115	0.125	2.920	3.170
B	0.260	0.280	6.600	7.110
C	0.220	0.245	5.590	6.220
D	0.075	0.095	1.900	2.410
E	0.038	0.058	0.970	1.470
F	-	0.020	-	0.510
G	0.380	0.400	9.640	10.160
H	0.024	0.040	0.610	1.020
I	0.006	0.016	0.150	0.410
J	-	0.050	-	1.270
K	-	0.310	-	7.870
L	-	0.050	-	1.270
M	-	0.125	-	3.170
N	0.002	0.008	0.050	0.200

Part Numbering System

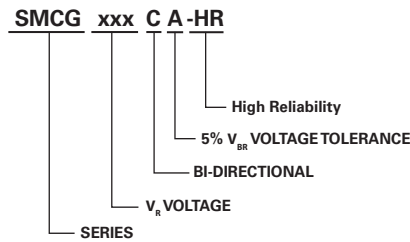

Part Marking System

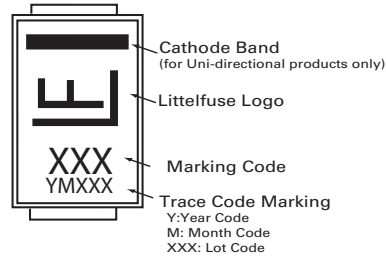

Packaging

Part number	Component Package	Quantity	Packaging Option	Packaging Specification
SMCGxxxXX-HR	DO-215AB	1500	Tape & Reel – 24mm tape /13" reel	EIA STD RS-481

Tape and Reel Specification

