

THIN SMD LOW / MEDIUM FREQUENCY CRYSTAL UNIT

FC-255

Product number (please refer to page 1)

Q1 x FC255xxxxx00

- High-density mounting-type SMD of 0.8 mm Typ. thickness.
- Small packaging area and light weight.
- Excellent environmental capability.
- Most suitable for small communications devices.
- Available for lead (Pb)-free soldering.
- Lead (Pb)-free terminal product.

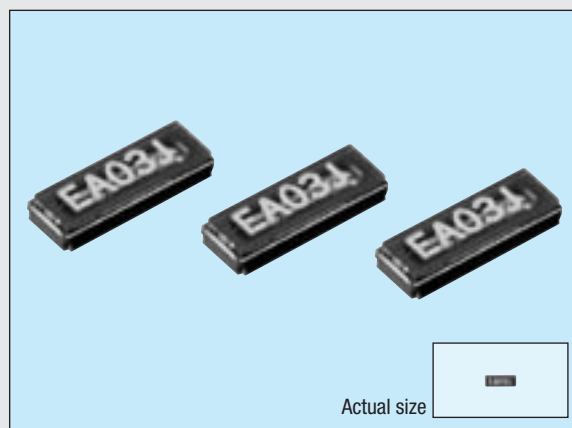

■ Specifications (characteristics)

Item		Symbol	Specifications		Remarks
Nominal frequency range		f	32.768 kHz	32.000 kHz	please contact us for inquiries about the available frequency
Temperature range	Storage temperature	T _{STG}	-55 °C to +125 °C		Stored as bare product after unpacking
	Operating temperature	T _{OPR}	-40 °C to +85 °C		
Maximum drive level		GL	0.5 μW Max.		
Frequency tolerance (standard)		Δf/f	±20 x 10 ⁻⁶	±50 x 10 ⁻⁶ , ±100 x 10 ⁻⁶	T _a = +25 °C, DL = 0.1 μW Please ask tighter tolerance
Peak temperature (frequency)		θT	+25 °C ±5 °C		
Temperature coefficient (frequency)		a	-0.04 x 10 ⁻⁶ / °C ² Max.		
Load capacitance		C _L	7 pF, 12.5 pF		Please specify
Series resistance		R ₁	65 kΩ Max.	70 kΩ to 25 kΩ	
Motional capacitance		C ₁	1.7 fF Typ.	2.5 fF to 0.7 fF	
Shunt capacitance		C ₀	1.3 pF Typ.	1.6 pF to 0.7 pF	
Insulation resistance		IR	500 MΩ Min.		
Aging		fa	±3 x 10 ⁻⁶ / year Max.		T _a = +25 °C ±3 °C, first year
Shock resistance		S.R.	±8 x 10 ⁻⁶ Max.		100 g dummy (Seiko Epson Standard) drop from 1500 mm height on to the concrete 3 directions 10 times.

■ External dimensions

(Unit: mm)

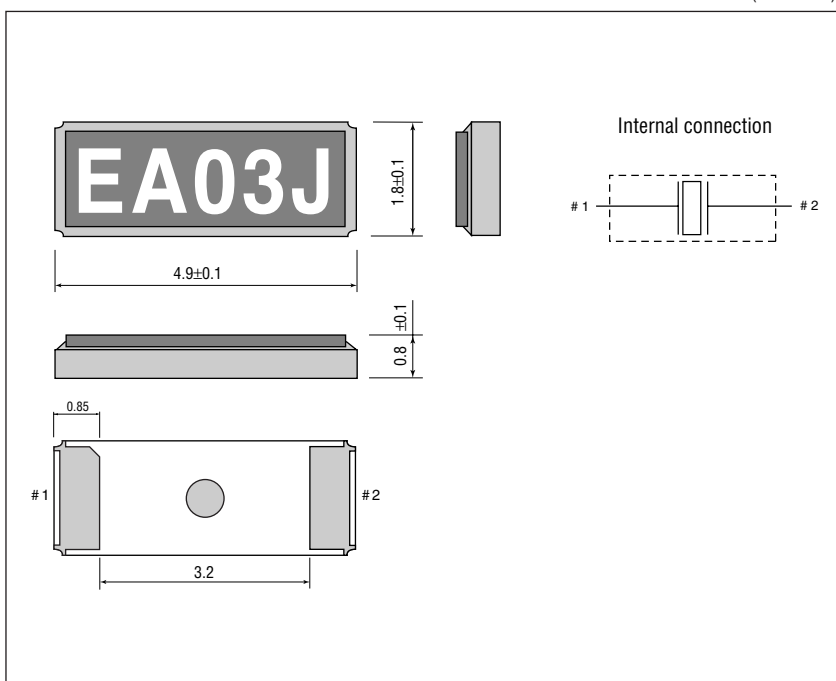

■ Recommended soldering pattern

(Unit: mm)

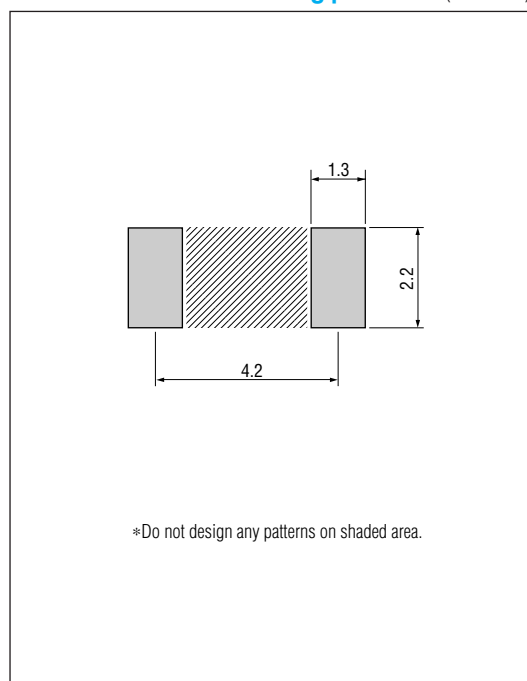

THE CRYSTALMASTER



ENERGY SAVING EPSON

EPSON offers effective savings to its customers through a wide range of electronic devices, such as semiconductors, liquid crystal display (LCD) modules, and crystal devices. These savings are achieved through a sophisticated melding of three different efficiency technologies.

Power saving technology provides low power consumption at low voltages.

Space saving technology provides further reductions in product size and weight through super-precise processing and high-density assembly technology.

Time saving technology shortens the time required for design and development on the customer side and shortens delivery times.

Our concept of Energy Saving technology conserves resources

by blending the essence of these three efficiency technologies. The essence of these technologies is represented in each of the products that we provide to our customers.

In the industrial sector, leading priorities include measures to counter the greenhouse effect by reducing CO₂, measures to preserve the global environment, and the development of energy-efficient products. Environmental problems are of global concern, and although the contribution of energy-saving technology developed by EPSON may appear insignificant, we seek to contribute to the development of energy-saving products by our customers through the utilization of our electronic devices. EPSON is committed to the conservation of energy, both for the sake of people and of the planet on which we live.

WORKING WITH ENVIRONMENTAL ISSUES

In 1988, Seiko Epson led in working to abolish CFCs, and perfect abolition of those ozone layer-destroying substances was achieved in 1992. In 1998, the 10th year of start of the CFC-free activity, Seiko Epson set this year as the "Second Environmental Benchmark Year" and established a new corporate General Environmental Policy. Seiko Epson is tackling with environmental issues comprehensively.

At the end of Fiscal 1988, Seiko Epson succeeded in abolishing chloric solvents doubted to be harmful to human body. In fiscal 1999, Seiko Epson started the activity with a goal of abolishing lead solder pointed out possibility of environmental pollutant.

Promotion of Environment Management System conforming to International Standard

To strengthen management for environmental activities, Seiko Epson Group aims at acquisition of the ISO14001 certification for Japanese and abroad main business bases (including affiliates) for manufacturing, sales, software development and others.

As of May 25, 2001, planned 68 bases of all manufacturing bases and some non-manufacturing bases have acquired the certification.



Co-existence Mark

The environmental mark symbolizing Epson's basic stance of "Co-existence with Nature". The design incorporates a fish, flower, and water, representing mutually supportive co-existence.



ISO14000 is an international standard for environmental management that was established by the International Standards Organization in 1996 against the background of growing concern regarding global warming, destruction of the ozone layer, and global deforestation.

WORKING FOR HIGH QUALITY

Seiko-Epson quickly began working to acquire company-wide ISO9000 series certification, and has acquired ISO9001 or ISO9002 certification with all targeted products manufactured in Japanese and overseas plants.

The Quartz Device Operations Division (Ina Japan, EPM and SZE) have acquired QS-9000 certification, which are of higher level.



QS-9000:

This is an enhanced standard for quality assurance systems formulated by leading U.S. automobile manufacturers based on the international ISO 9000 series.

NOTICE

- The material is subject to change without notice.
- Any part of this material may not be reproduced or duplicated in any form or any means without the written permission of Seiko Epson.
- The information, applied circuit, program, using way etc., written in this material is just for reference. Seiko Epson does not assume any liability for the occurrence of infringing any patent or copyright of third party. This material does not authorize the licence for any patent or intellectual property rights.
- Any product described in this material may contain technology or the subject relating to strategic products under the control of the Foreign Exchange and Foreign Trade Law of Japan and may require an export licence from the Ministry of International Trade and industry or other approval from another government agency.
- The products (except for some product for automotive applications) listed up on this material are designed to be used with ordinary electronic equipment (OA equipment, AV equipment, communications equipment, measuring instruments etc). Seiko Epson does not assume any liability for the case using the products with the application required high reliability or safety extremely (such as aerospace equipment etc). When intending to use any our product with automotive application and the other application than ordinary electronic equipments as above, please contact our sales representatives in advance.