

Features

- * 350W peak pulse power (8/20 μ s)
- * Protects one data or power line
- * Ultra low leakage: nA level
- * Operating voltage: 12V
- * Ultra low clamping voltage
- * Complies with following standards:
 - IEC 61000-4-2 (ESD) immunity test
 - Air discharge: ± 30 kV
 - Contact discharge: ± 30 kV
 - IEC61000-4-4 (Lightning) 16A (8/20ns)

Mechanical Characteristics

- * Package: SOD-323
- * Lead Finish: Matte Tin
- * Case Material: "Green" Molding Compound.
- * UL Flammability Classification Rating 94V-0
- * Moisture Sensitivity: Level 3 per J-STD-020
- * Terminal Connections: See Diagram Below

Applications

- * Cellular Handsets and Accessories
- * Personal Digital Assistants
- * Notebooks and Handhelds
- * Portable Instrumentation
- * Peripherals
- * Pagers Peripherals

Ordering Information

Part Number	Qty per Reel	Reel Size
TPCDSOD323-T12SC	3000	7"

Dimensions and Pin Configuration

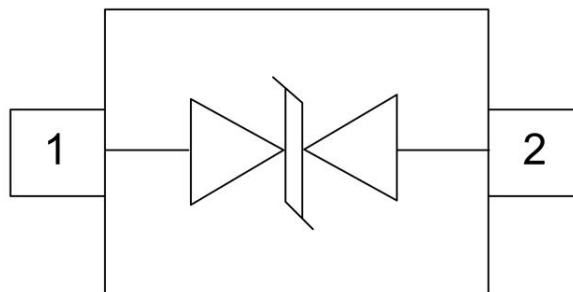

marking: 12 or 12C

Absolute Maximum Ratings (Tamb=25°C unless otherwise specified)

Parameter	Symbol	Value	Unit
Peak Pulse Power (8/20μs)	Ppk	350	W
Peak Pulse Current (8/20μs)	IPP	16	A
ESD per IEC 61000-4-2 (Air)	VESD	±30	kV
ESD per IEC 61000-4-2 (Contact)		±30	
Operating Temperature Range	TJ	-55 to +125	°C
Storage Temperature Range	Tstg	-55 to +150	°C

Electrical Characteristics (TA=25°C unless otherwise specified)

Symbol	Parameter
V_{RWM}	Nominal Reverse Working Voltage
I_R	Reverse Leakage Current @ V_{RWM}
V_{BR}	Reverse Breakdown Voltage @ I_T
I_T	Test Current for Reverse Breakdown
V_C	Clamping Voltage @ I_{PP}
I_{PP}	Maximum Peak Pulse Current
C_{ESD}	Parasitic Capacitance
V_R	Reverse Voltage
f	Small Signal Frequency

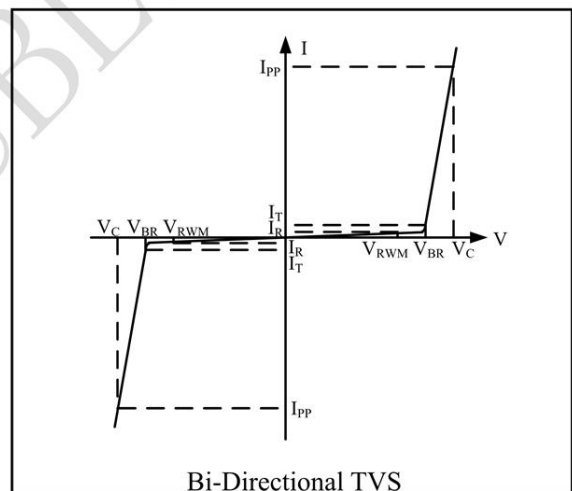

Parameter	Symbol	Min	Typ	Max	Unit	Test Condition
Reverse Working Voltage	V_{RWM}			12	V	
Breakdown Voltage	V_{BR}	13.3			V	$I_T = 1\text{mA}$
Reverse Leakage Current	I_R			0.5	μA	$V_{RWM} = 12\text{V}$
Forward Voltage	V_F		0.8	1.2	V	$I_F = 10\text{mA}$
Clamping Voltage	V_C		15		V	$I_{PP} = 1\text{A}$ (8 x 20μs pulse)
Clamping Voltage	V_C		24		V	$I_{PP} = 16\text{A}$ (8 x 20μs pulse)
Junction Capacitance	C_J			70	pF	$V_R = 0\text{V}$, f = 1MHz

Fig1. 8/20 μ s Pulse Waveform

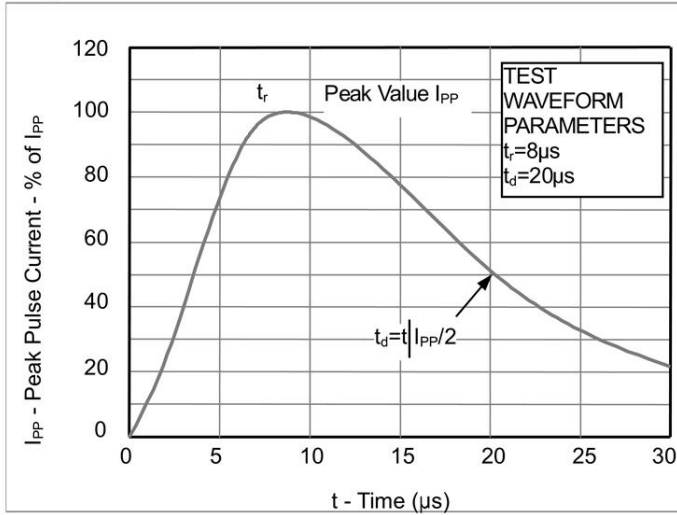

Fig2. ESD Pulse Waveform (according to IEC 61000-4-2)

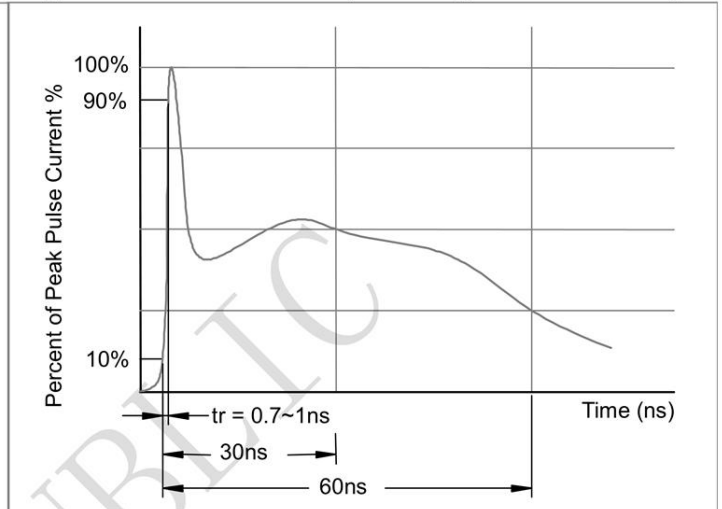
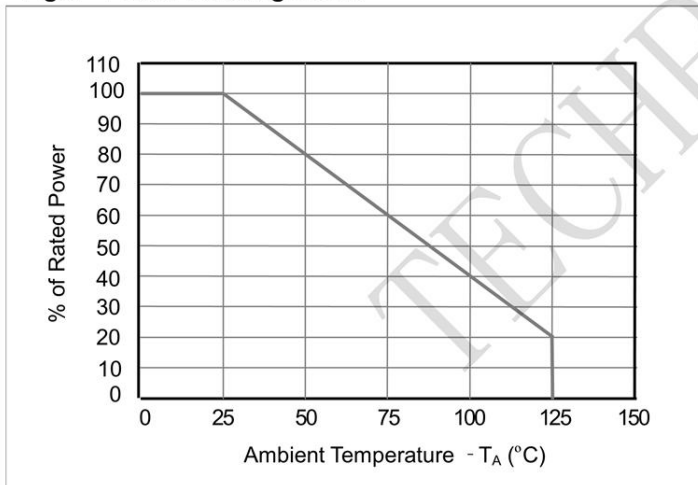
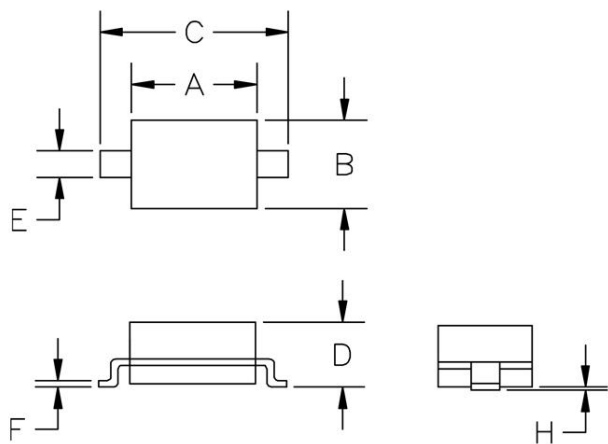

Fig3. Power Derating Curve



Outline Drawing - SOD-323



SYM	DIMENSIONS			
	MILLIMETERS		INCHES	
	MIN	MAX	MIN	MAX
A	1.50	1.80	0.060	0.071
B	1.20	1.40	0.045	0.054
C	2.30	2.70	0.090	0.107
D	-	1.10	-	0.043
E	0.30	0.40	0.012	0.016
F	0.10	0.25	0.004	0.010
H	-	0.10	-	0.004

Land Pattern - SOD-323

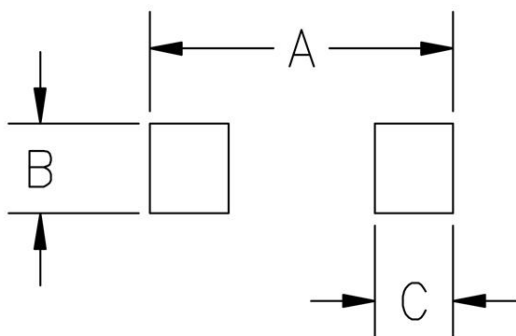

SYM	DIMENSIONS	
	MILLIMETERS	INCHES
A	3.15	0.120
B	0.80	0.031
C	0.80	0.031