

mm inch

FEATURES

- **Low profile**
<Height>
PC board terminal type: 9.5 mm .374 inch
Surface-mount terminal type: 10.5mm .413inch
- **High capacity**
CP Relay provides low profile spacesaving advantages while offering high continuous current of 25 A(1 hour).
- **Sealed construction suitable for harsh environments**

- **Simple footprint pattern enables ease of PC board layout**

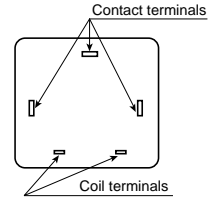

- **"PC board terminal" and "Surface mount terminal" types available**

*Surface mount terminal type is coming soon.

SPECIFICATIONS

Contact

Arrangement	1 Form A	1 Form C	
Contact material	Silver alloy		
Initial contact resistance, max. (By voltage drop 6V DC 1A)	100 mΩ		
Rating	Nominal switching capacity	20 A 14 V DC 20 A 14 V DC (N.O.) 10 A 14 V DC (N.C.)	
	Max. switching voltage	16 V DC	
	Max. carrying current	40 A for 2 minutes 30 A for 1 hour (12 V at 20°C 68°F) 35 A for 2 minutes 25 A for 1 hour (12 V at 85°C 185°F)	
Expected life (min. operations)	Mechanical (at 120cpm)	10 ⁷	
	Electrical (at 6cpm)	Resistive load	Min. 10 ^{5*}
		Motor load	Min. 2×10 ^{5*2}
		Lamp load	Min. 10 ^{5*3}

Coil

Nominal operating power	640 mW
-------------------------	--------

Remarks

- * Specifications will vary with foreign standards certification ratings.
- *1 At nominal switching capacity, operating frequency: 1s ON, 9s OFF
- *2 N.O.: at 5A (steady), 25A (inrush)/N.C.: at 20A (brake) 14V DC, operating frequency: 0.5s ON, 9.5s OFF
- *3 At 20A 14V DC (Motor lock), operating frequency: 0.5s ON, 9.5s OFF
- *4 N.O.: at 5A (steady), 40A (inrush)14V DC, operating frequency: 1s ON, 14s OFF
- *5 Measurement at same location as "Initial breakdown voltage" section

Characteristics

Max. operating speed (at rated load)	6cpm	
Initial insulation resistance*5	Min. 100MΩ (at 500 V DC)	
Initial breakdown voltage*6	Between open contacts	500 Vrms for 1min.
	Between contact and coil	500 Vrms for 1min.
Operate time*7	Max. 10ms (at 20°C 68°F)	
Release time (without diode)*7 (at nominal voltage)	Max. 10ms (at 20°C 68°F)	
Shock resistance	Functional*8	Min. 100 m/s ² {10 G}
	Destructive*9	Min. 1,000 m/s ² {100 G}
Vibration resistance	Functional*10	10 to 100 Hz, Min.44.1 m/s ² {4.5 G}
	Destructive	10 to 500 Hz, Min.44.1 m/s ² {4.5 G}
Conditions in case of operation, transport and storage*11 (Not freezing and condensing at low temperature)	Ambient temp	-40 to +85°C -40 to +185°F
	Humidity	5 to 85% R.H.
Unit weight	Approx. 4g .14 oz	

- *6 Detection current: 10mA
- *7 Excluding contact bounce time
- *8 Half-wave pulse of sine wave: 11ms; detection time: 10μs
- *9 Half-wave pulse of sine wave: 6ms
- *10 Detection time: 10μs
- *11 Refer to 5. Conditions for operation, transport and storage mentioned in AMBIENT ENVIRONMENT (Page 61)

TYPICAL APPLICATIONS

- Power windows
- Auto door lock
- Power sunroof
- Hazard flasher
- Flasher
- Defogger
- Power steering
- Power seat

ORDERING INFORMATION

Ex. CP 1a SA — 12V — X

Contact arrangement	Mounting classification	Coil voltage (DC)	Packing style
1a: 1 Form A 1: 1 Form C	Nil: PC board terminal SA: Surface-mount terminal*	12 V	Nil: Tube packing X: Tape and reel packing (picked from the NC terminal side) Z: Tape and reel packing (picked from the coil terminal side)

- Notes: 1. Standard packing: Carton (Tube): 40 pcs.; Case: 1,000 pcs. *Only for 1 Form C type
2. Tape and reel packing: Carton (Tape and reel): 300 pcs.; Case: 900 pcs.
3. Surface-mount terminal type are available only for tape and reel packing.
4. 24 V DC type is also available. Please consult us for details.

TYPES

1. PC board terminal type

Contact arrangement	Coil voltage	Part No.
1 Form A	12 V DC	CP1a-12V
1 Form C	12 V DC	CP1-12V

2. Surface mount terminal type

Contact arrangement	Coil voltage	Part No.
1 Form C	12 V DC	CP1SA-12V-Z

Notes:

1. Tape and reel (picked from N.C. terminal side) is also available by request. Part No. suffix "-x" is needed when ordering. (ex) CP1SA-12V-X
2. Tape and reel packing symbol "-z" or "-x" are not marked on the relay.
3. 24 V DC type is also available. Please consult us for details.

COIL DATA (at 20°C 68°F)

Nominal voltage, V DC	Pick-up voltage, V DC (max.)	Drop-out voltage, V DC (min.)	Coil resistance Ω ($\pm 10\%$)	Nominal operating current mA ($\pm 10\%$)	Nominal operating power mW	Usable voltage range, V DC
12	(initial) 7.2	(initial) 1.0	225	53.3	640	10 to 16

DIMENSIONS

mm inch

1. PC board terminal type

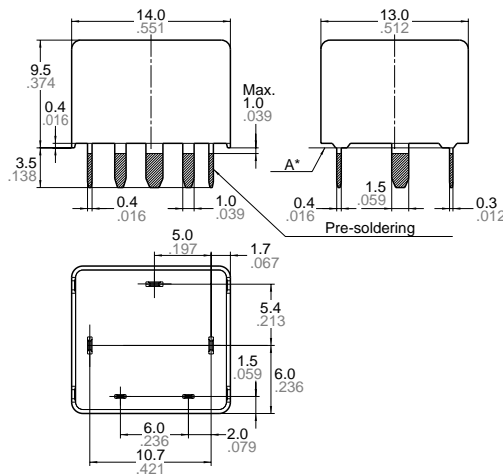

Schematic (Bottom view)
1a

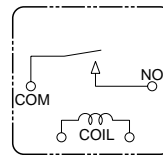

PC board pattern (Bottom view)
1a

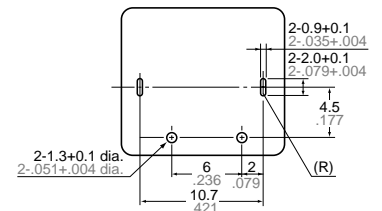

1c

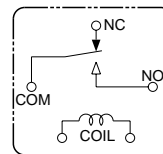

1c

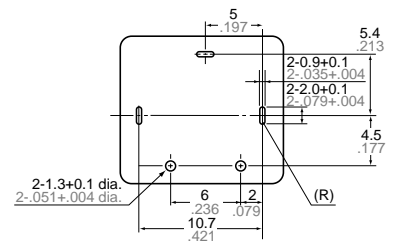

Dimension:

Max. 1mm .039 inch:

1 to 3mm .039 to .118 inch:

Min. 3mm .118 inch:

General tolerance

$\pm 0.1 \pm .004$

$\pm 0.2 \pm .008$

$\pm 0.3 \pm .012$

* Dimensions (thickness and width) of terminal specified in this catalog is measured before pre-soldering. Intervals between terminals is measured at A surface level.

2. Surface mount terminal type

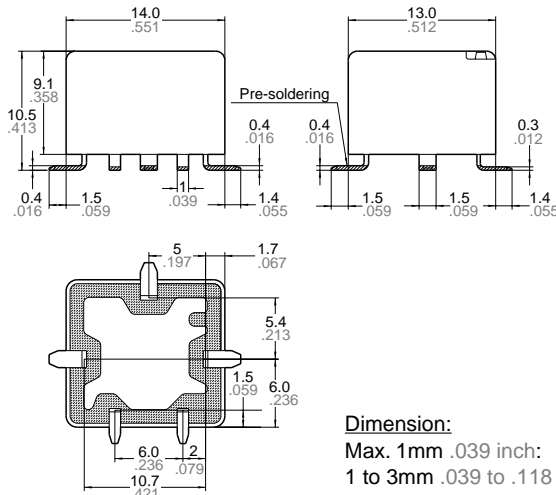

Recommendable mounting pad (Top view)

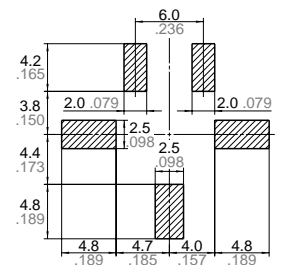

Dimension:

Max. 1mm .039 inch:

1 to 3mm .039 to .118 inch:

Min. 3mm .118 inch:

General tolerance

$\pm 0.1 \pm .004$

$\pm 0.2 \pm .008$

$\pm 0.3 \pm .012$

REFERENCE DATA

1. Coil temperature rise

Tested sample : CP1-12V, 6pcs
 Point measured : Inside the coil
 Contact carrying current, 5A, 10A, 15A, 20A
 Resistance method, ambient temperature 85°C 185°F

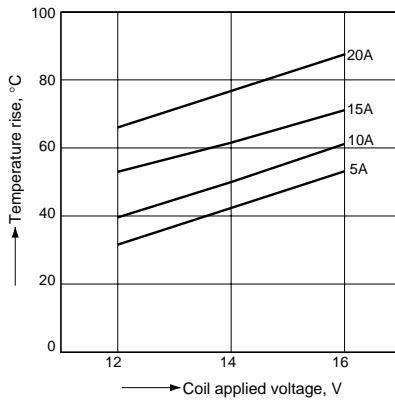

2-(1). Electrical life test (at rated load)

Tested Sample : CP1-12V
 Quantity : n = 4 (NC = 2, NO = 2)
 Load : Resistive load (NC side : 10A 14 V DC, NO side : 20 A 14 V DC)
 Operating frequency : ON 1s, OFF 9s

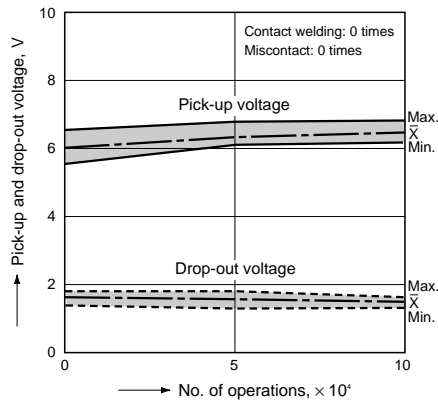

Contact welding : 0 time
 Miscontact : 0 time

2-(2). Electrical life test (Motor free)

Tested Sample : CP1-12V, 3pcs.
 Load : 5A, Inrush 25A, Brake current 15A, Power window motor load (Free condition).
 Operating frequency : ON 0.5s, OFF 9.5s

Circuit :

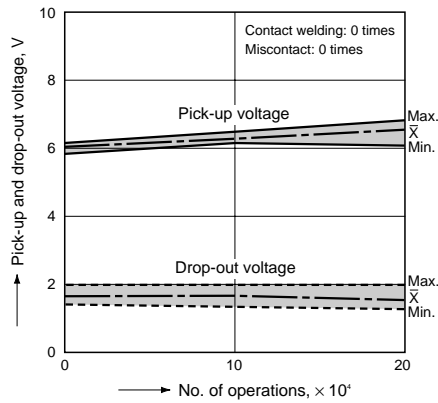
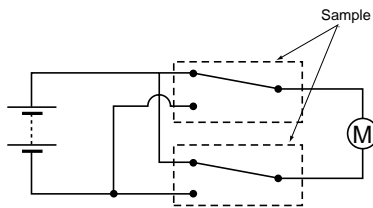

Contact welding : 0 time
 Miscontact : 0 time

2-(3). Electrical life test (Lamp load)

Tested sample : CP1-12V, 3pcs.
 Load : 5A, Inrush 40A, 14VDC lamp load
 Operating frequency : ON 1s, OFF 14s

Circuit :

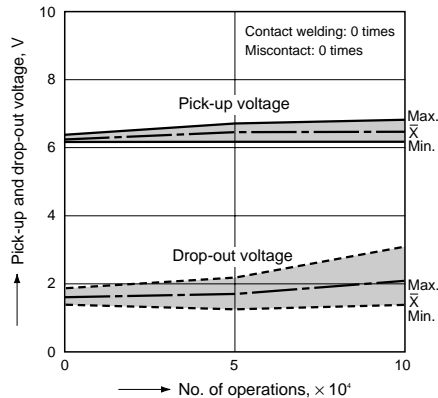
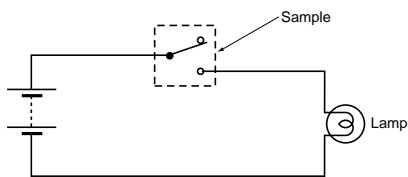

Contact welding : 0 time
 Miscontact : 0 time

For Cautions for use, see Relay Technical Information (Page 48 to 76).