

SMD ■ MID POWER LED

62-227B/XK2C-SXXXXXXXXXXZ12/2T



Features

- PLCC-4 Package
- Top view white LED
- Two dies parallel connected.
- High luminous flux output
- High current capability
- Wide viewing angle
- Pb-free
- RoHS compliant
- ANSI Binning

Description

The Everlight 0.4W 62-227B package has high efficacy, high CRI, low power consumption, wide viewing angle and a compact form factor. These features make this package an ideal LED for all lighting application.

Applications

- Decorative and Entertainment Lighting
- Light pipe application
- Indicator and backlight in office and family equipment
- General use

Product Number Explanation

62-227B / XK 2 C - S XX XX XX XX XX Z12/ 2T

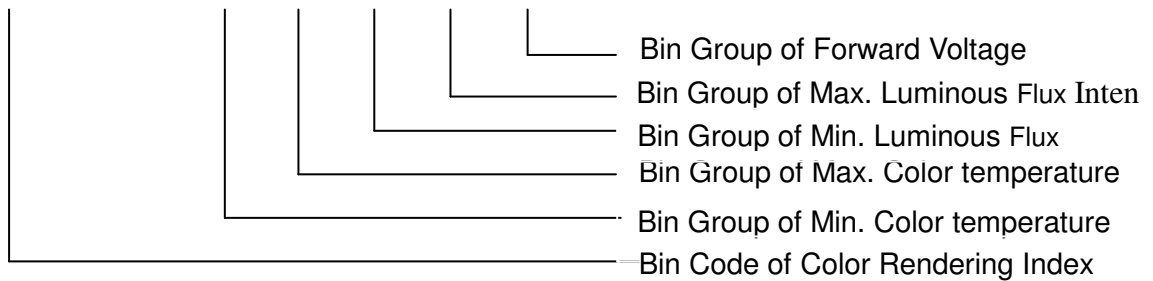

Table of Color Rendering Index

Symbol	Description
M	CRI(Min.) : 60
N	CRI(Min.) : 65
L	CRI(Min.) : 70
Q	CRI(Min.) : 75
K	CRI(Min.) : 80
H	CRI(Min.) : 90

Notes:
 Tolerance of Color Rendering Index: ±2

Table of Forward Current Index

Symbol	Description
Z12	I _F :120mA

Example:
 62-227B/QK2C-S5757P4Q3B2Z12/2T

CRI	75(Min.)
CCT	5700K
Flux	39~52lm
V _F	2.9V~3.6V
I _F	120mA

Mass Production list

Product	CRI Min.	CCT(K)	Φ(lm) Min.	Φ(lm) Typ.	Φ(lm) Max.
62-227B/QK2C-S6565P4Q3B2Z12/2T	75	6500K	39	41	52
62-227B/QK2C-S5757P4Q3B2Z12/2T	75	5700K	39	45	52
62-227B/QK2C-S5050P4Q3B2Z12/2T	75	5000K	39	45	52

Mass Production list

Product	CRI Min.	CCT(K)	Φ(lm) Min.	Φ(lm) Typ.	Φ(lm) Max.
62-227B/KK2C-S4040P3P4B2Z12/2T	80	4000K	33	41	45
62-227B/KK2C-S3535P3P4B2Z12/2T	80	3500K	33	39	45
62-227B/KK2C-S3030P3P4B2Z12/2T	80	3000K	33	39	45
62-227B/KK2C-S2727N4P3B2Z12/2T	80	2700K	27	33	39

Notes:
 Tolerance of Luminous flux: ±11%.

Device Selection Guide

Chip Materials	Emitted Color	Resin Color
InGaN	Cool White Neutral White Warm White	Water Clear

Absolute Maximum Ratings (T_{Soldering}=25°C)

Parameter	Symbol	Rating	Unit
Forward Current	I _F	200	mA
Peak Forward Current (Duty 1/10 @10ms)	I _{FP}	600	mA
Power Dissipation	P _d	740	mW
Electrostatic Discharge(HBM)	ESD	2000	V
Operating Temperature	T _{opr}	-40 ~ +85	°C
Storage Temperature	T _{stg}	-40 ~ +100	°C
Thermal Resistance (Junction / Soldering point)	R _{th J-S}	22	°C/W
Junction Temperature	T _j	115	°C
Soldering Temperature	T _{sol}	Reflow Soldering : 260 °C for 10 sec. Hand Soldering : 350 °C for 3 sec.	

Notes:

1. The value are based on two dies parallel connected..
2. The products are sensitive to static electricity and must be carefully taken when handling products.

Electro-Optical Characteristics (T_{Soldering}=25°C)

Parameter	Symbol	Min.	Typ.	Max.	Unit	Condition
Luminous Flux	Φ	27	-----	52	lm	I _F =120mA
Forward Voltage	V _F	2.9	-----	3.6	V	I _F =120mA
Viewing Angle	2θ _{1/2}	-----	120	-----	deg	I _F =120mA

Notes:

1. The value are based on two dies for parallel connected.
2. Tolerance of Luminous flux: ±11%.
3. Tolerance of Forward Voltage : ±0.1V.

Bin Range of Luminous Flux

Bin Code	Min.	Max.	Unit	Condition
N4	27	33	lm	I _F =120mA
P3	33	39		
P4	39	45		
Q3	45	52		

Notes:

1. The value are based on two dies for parallel connected.
2. Tolerance of Luminous flux: ±11%

Bin Range of Forward Voltage

Group	Bin Code	Min.	Max.	Unit	Condition
B2	36	2.9	3.0	V	I _F =120mA
	37	3.0	3.1		
	38	3.1	3.2		
	39	3.2	3.3		
	40	3.3	3.4		
	41	3.4	3.5		
	42	3.5	3.6		

Notes:

1. The value are based on two dies for parallel connected.
2. Tolerance of Forward Voltage : ±0.1V.

Electro-Optical Characteristics

Warm White

I _f (mA)	V _f (V)	Power(W)	Flux(lm)	Lm/W
50	2.77	0.14	17.0	121.4
100	2.92	0.29	31.1	107.2
120	3.04	0.37	37.3	102.3
150	3.11	0.47	44.6	95.5
180	3.17	0.57	51.1	89.6

Cool White

I _f (mA)	V _f (V)	Power(W)	Flux(lm)	Lm/W
50	2.81	0.14	19.1	136.4
100	2.98	0.30	33.1	110.3
120	3.09	0.37	39.2	105.9
150	3.15	0.47	46.8	99.5
180	3.19	0.57	52.6	92.3

Notes: Data is only for reference.

Bin Range of Chromaticity Coordinate

CCT	Bin Code	CIE_x	CIE_y	Bin Code	CIE_x	CIE_y
6500K	65K-1	0.3205	0.3481	65K-3	0.3131	0.3290
		0.3117	0.3393		0.3048	0.3209
		0.3131	0.3290		0.3068	0.3113
		0.3213	0.3371		0.3145	0.3187
	65K-2	0.3117	0.3393	65K-4	0.3213	0.3371
		0.3028	0.3304		0.3131	0.3290
		0.3048	0.3209		0.3145	0.3187
		0.3131	0.3290		0.3221	0.3261
5700K	57K-1	0.3376	0.3616	57K-3	0.3293	0.3423
		0.3292	0.3539		0.3215	0.3353
		0.3293	0.3423		0.3222	0.3243
		0.3371	0.3493		0.3294	0.3306
	57K-2	0.3292	0.3539	57K-4	0.3371	0.3493
		0.3207	0.3462		0.3293	0.3423
		0.3215	0.3353		0.3294	0.3306
		0.3293	0.3423		0.3366	0.3369
5000K	50K-1	0.3551	0.3760	50K-3	0.3452	0.3558
		0.3464	0.3688		0.3371	0.3493
		0.3452	0.3558		0.3366	0.3369
		0.3533	0.3624		0.3441	0.3428
	50K-2	0.3464	0.3688	50K-4	0.3533	0.3624
		0.3376	0.3616		0.3452	0.3558
		0.3371	0.3493		0.3441	0.3428
		0.3452	0.3558		0.3515	0.3487
4000K	40K-1	0.4006	0.4044	40K-3	0.3828	0.3803
		0.3871	0.3959		0.3703	0.3726
		0.3828	0.3803		0.3670	0.3578
		0.3952	0.3880		0.3784	0.3647
	40K-2	0.3871	0.3959	40K-4	0.3952	0.3880
		0.3736	0.3874		0.3828	0.3803
		0.3703	0.3726		0.3784	0.3647
		0.3828	0.3803		0.3898	0.3716

Bin Range of Chromaticity Coordinate

CCT	Bin Code	CIE_x	CIE_y	Bin Code	CIE_x	CIE_y
3500K	35K-1	0.4299	0.4165	35K-3	0.4083	0.3921
		0.4148	0.4090		0.3943	0.3853
		0.4083	0.3921		0.3889	0.3690
		0.4223	0.3990		0.4018	0.3752
	35K-2	0.4148	0.4090	35K-4	0.4223	0.3990
		0.3996	0.4015		0.4083	0.3921
		0.3943	0.3853		0.4018	0.3752
		0.4083	0.3921		0.4147	0.3814
3000K	30K-1	0.4562	0.4260	30K-3	0.4345	0.4033
		0.4431	0.4213		0.4223	0.3990
		0.4345	0.4033		0.4147	0.3814
		0.4468	0.4077		0.4260	0.3854
	30K-2	0.4431	0.4213	30K-4	0.4468	0.4077
		0.4299	0.4165		0.4345	0.4033
		0.4223	0.3990		0.4260	0.3854
		0.4345	0.4033		0.4373	0.3893
2700K	27K-1	0.4813	0.4319	27K-3	0.4585	0.4104
		0.4688	0.4290		0.4468	0.4077
		0.4585	0.4104		0.4373	0.3893
		0.4703	0.4132		0.4483	0.3919
	27K-2	0.4688	0.4290	27K-4	0.4703	0.4132
		0.4562	0.4260		0.4585	0.4104
		0.4468	0.4077		0.4483	0.3919
		0.4585	0.4104		0.4593	0.3944

Notes:

1. The value are based on two dies for parallel connection which driving current by 120mA.
2. Tolerance of Chromaticity Coordinates : ±0.01.

The C.I.E. 1931 Chromaticity Diagram

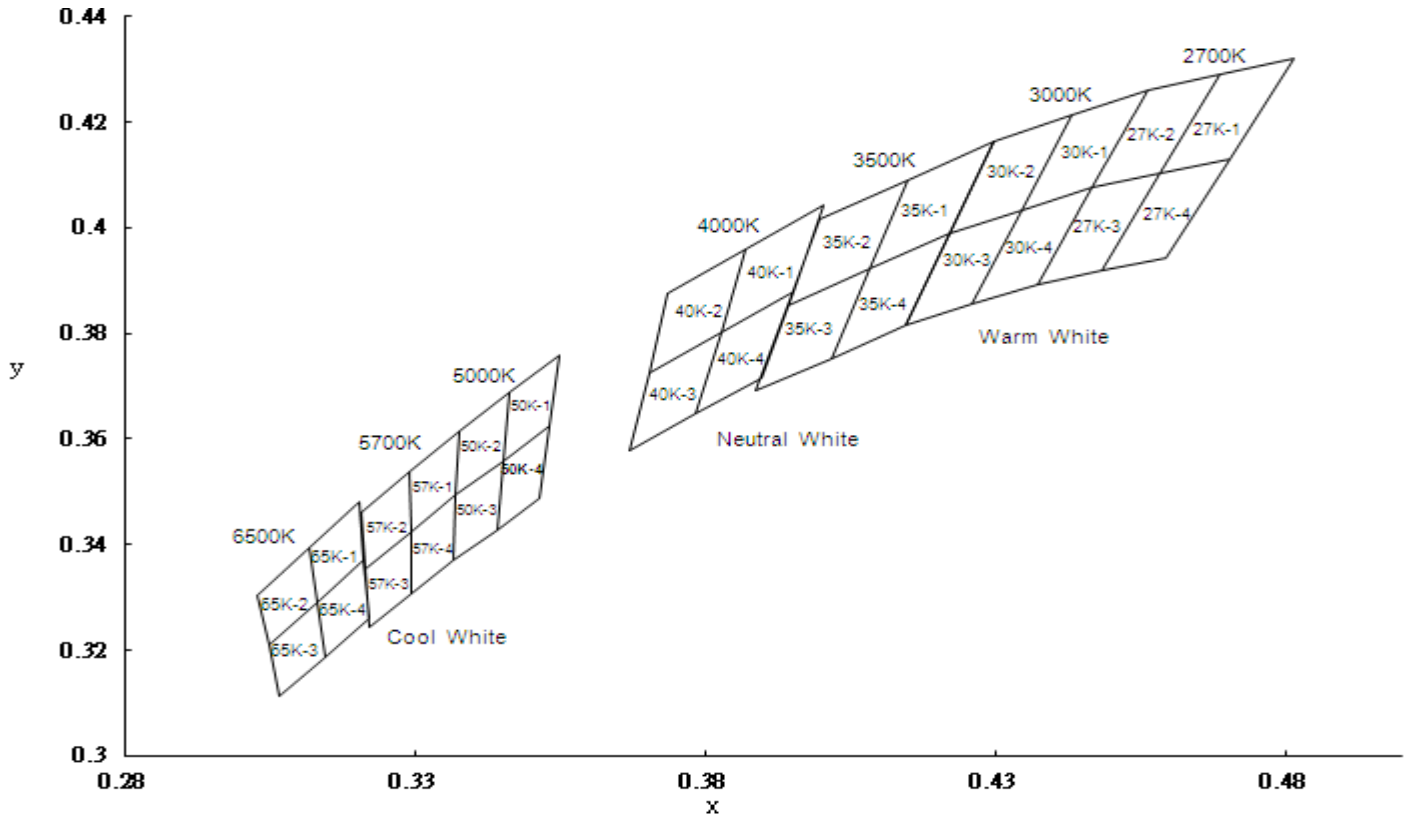

Spectrum Distribution

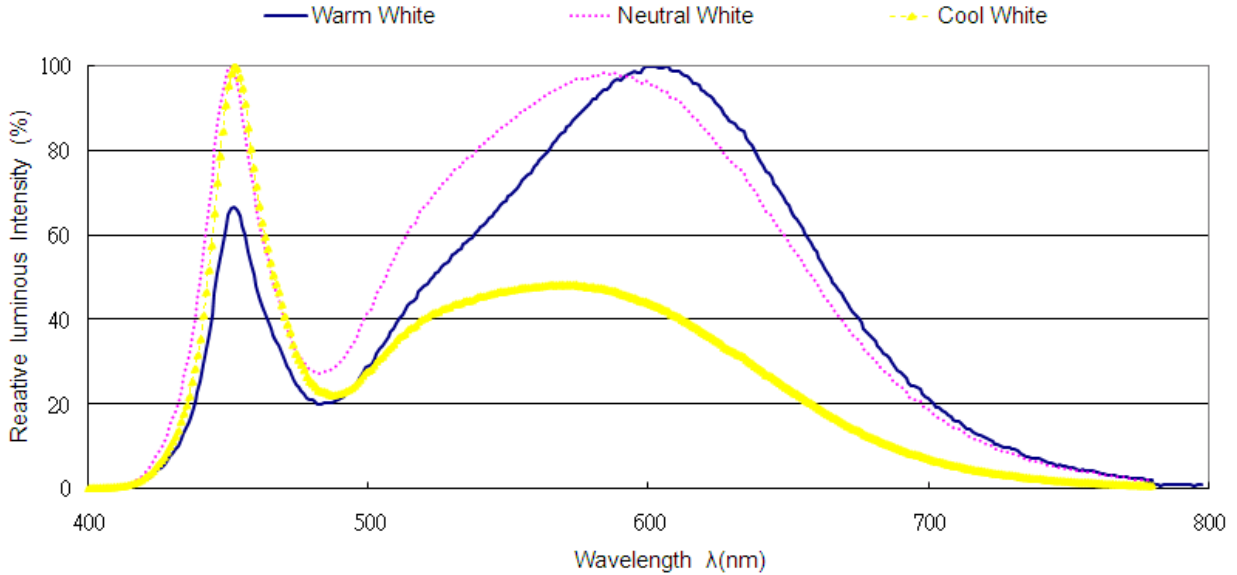

Typical Electro-Optical Characteristics Curves

Fig.1 - Forward Voltage Shift vs. Junction Temperature

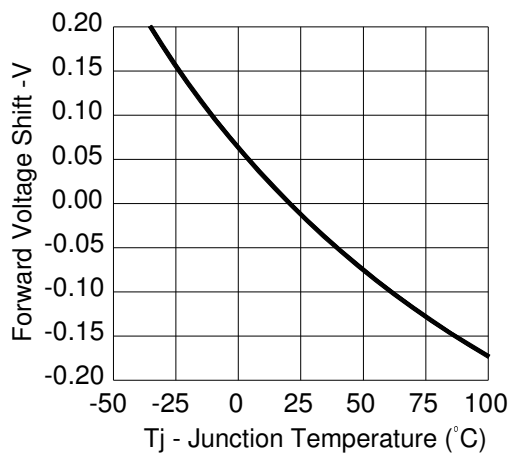
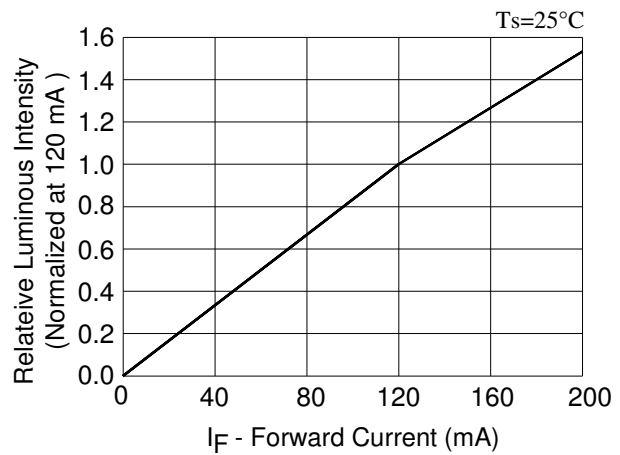

Fig.2 - Relative Luminous Intensity vs. Forward Current



Typical Electro-Optical Characteristics Curves

Fig.3 - Relative Luminous Intensity vs. Junction Temperature

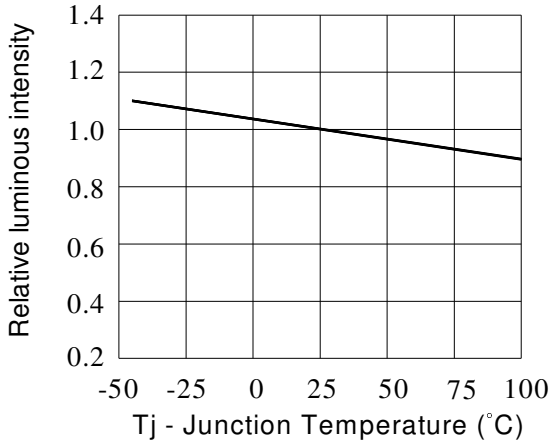

Fig.4 - Forward Current vs. Forward Voltage

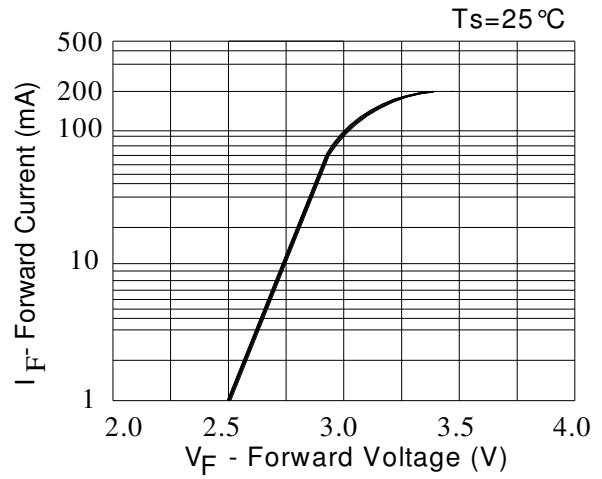

Fig.5 - Max. Driving Forward Current vs. Soldering Temperature

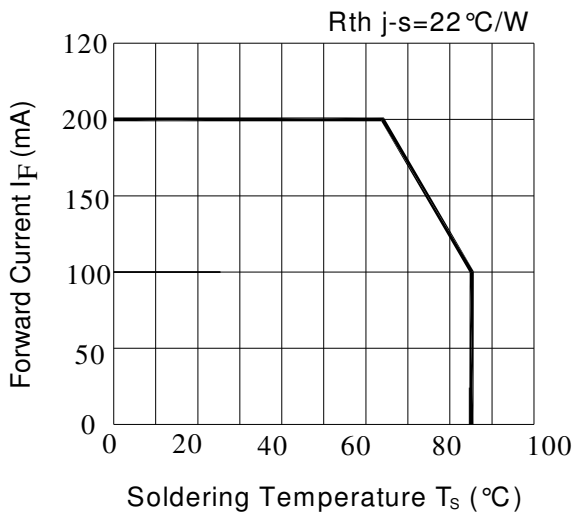
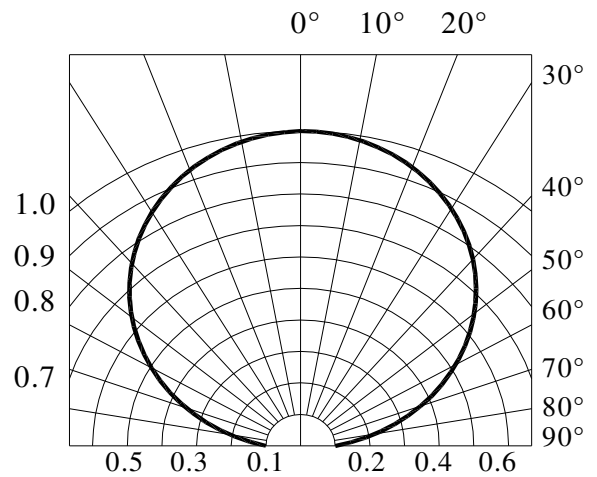
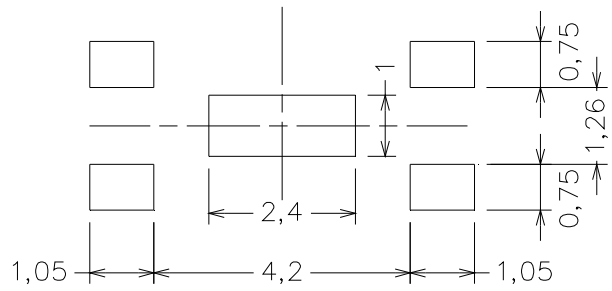
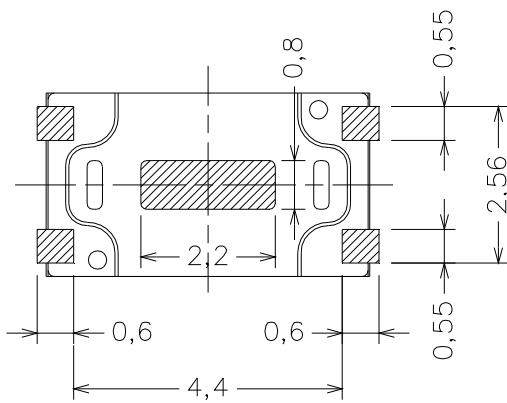
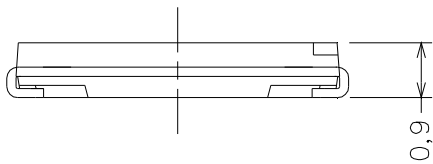
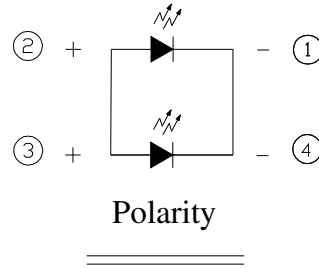
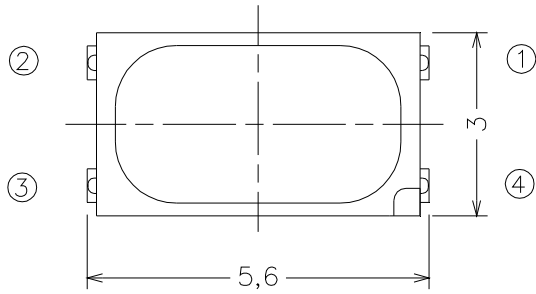

Fig.6 - Radiation Diagram



Package Dimension



Note:
 Tolerance unless mentioned is $\pm 0.2\text{mm}$; Unit = mm.

Moisture Resistant Packing Materials

Label Explanation



- CPN: Customer's Product Number
- P/N: Product Number
- QTY: Packing Quantity
- CAT: Luminous Intensity Rank
- HUE: Dom. Wavelength Rank
- REF: Forward Voltage Rank
- LOT No: Lot Number

Reel Dimensions

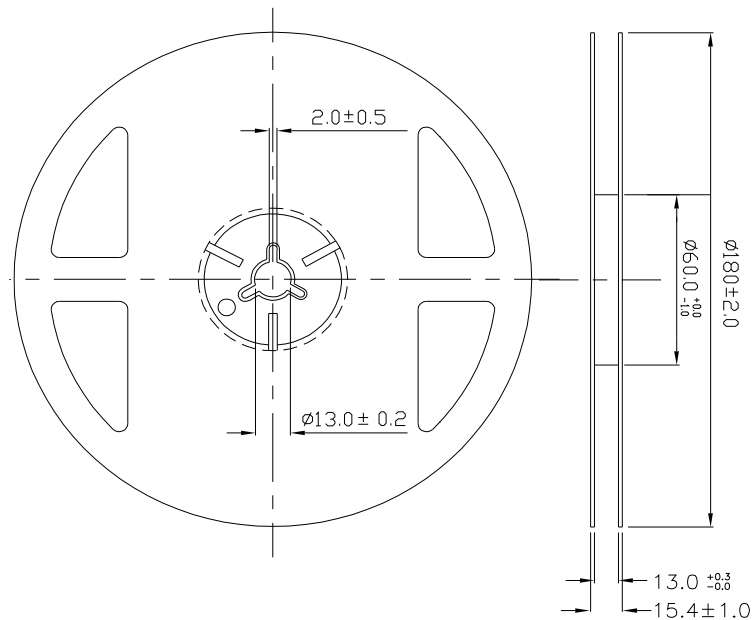

Note:
 Tolerances unless mentioned ± 0.1 mm. Unit = mm.

Carrier Tape Dimensions: Loaded Quantity 2000 pcs Per Reel

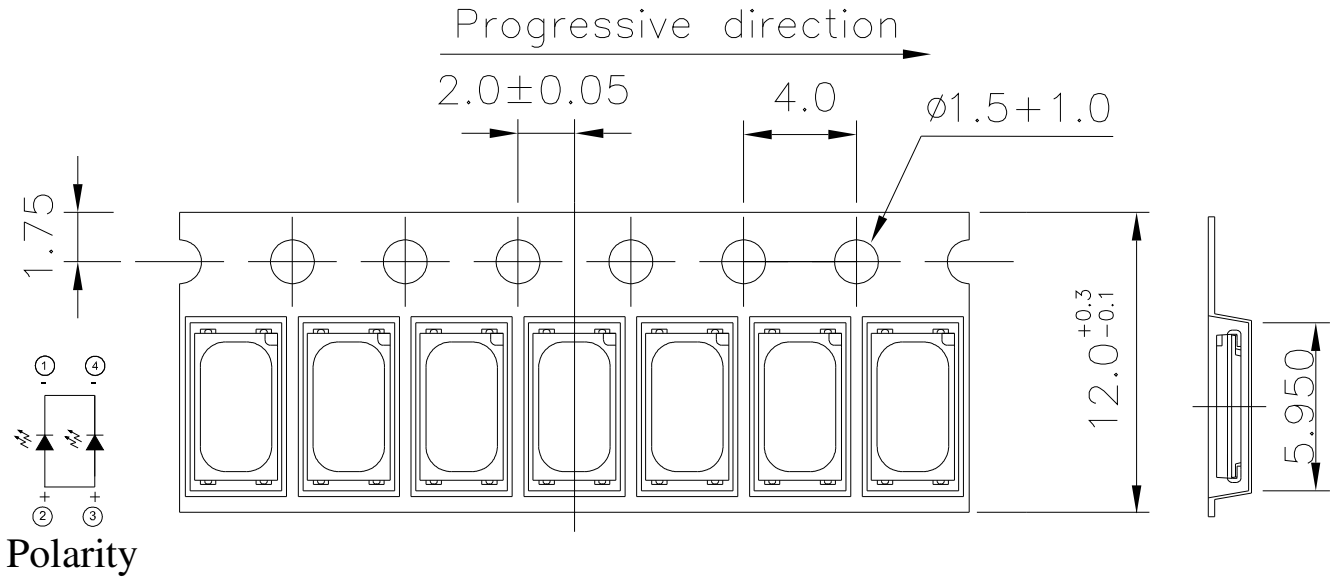

Note:
Tolerances unless mentioned ± 0.1 mm. Unit = mm.

Moisture Resistant Packing Process

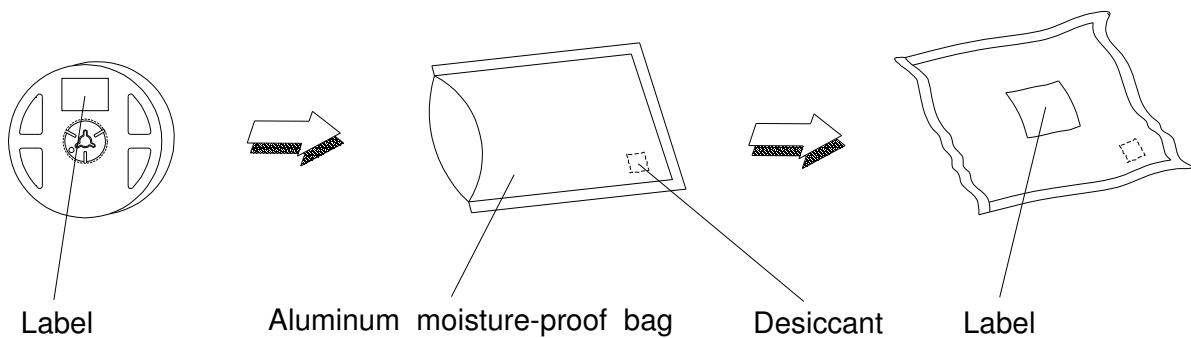

Reliability Test Items and Conditions

The reliability of products shall be satisfied with items listed below.

Confidence level : 90%

LTPD : 10%

No.	Items	Test Condition	Test Hours/Cycles	Sample Size	Ac/Re
1	Reflow Soldering	Temp. : 260°C/10sec.	6 Min.	22 PCS.	0/1
2	Thermal Shock	H : +100°C 5min ∫ 10 sec L : -10°C 5min	200 Cycles	22 PCS.	0/1
3	Temperature Cycle	H : +100°C 15min ∫ 5 min L : -40°C 15min	200 Cycles	22 PCS.	0/1
4	High Temperature/Humidity Storage	Ta=85°C,85%RH	1000 Hrs.	22 PCS.	0/1
5	High Temperature/Humidity Operation	Ta=85°C,85%RH, I _F = 100 mA	1000 Hrs.	22 PCS.	0/1
6	Low Temperature Storage	Ta=-40°C	1000 Hrs.	22 PCS.	0/1
7	High Temperature Storage	Ta=85°C	1000 Hrs.	22 PCS.	0/1
8	Low Temperature Operation Life	Ta=-40°C, I _F = 200 mA	1000 Hrs.	22 PCS.	0/1
9	High Temperature Operation/ Life#1	Ta=25°C, I _F = 200 mA	1000 Hrs.	22 PCS.	0/1
10	High Temperature Operation/ Life#2	Ta=55°C, I _F =200 mA	1000 Hrs.	22 PCS.	0/1
11	High Temperature Operation/ Life#3	Ta=85°C, I _F = 100 mA	1000 Hrs.	22 PCS.	0/1

Notes:

The value are based on two dies parallel connected.

Precautions for Use

1. Over-current-proof

Customer must apply resistors for protection; otherwise slight voltage shift will cause big current change (Burn out will happen).

2. Storage

2.1 Do not open moisture proof bag before the products are ready to use.

2.2 Before opening the package: The LEDs should be kept at 30°C or less and 90%RH or less.

2.3 After opening the package: The LED's floor life is 72 Hrs under 30°C or less and 60% RH or less. If unused LEDs remain, it should be stored in moisture proof packages.

2.4 If the moisture absorbent material (silica gel) has faded away or the LEDs have exceeded the storage time, baking treatment should be performed using the following conditions.

Baking treatment: 60±5°C for 24 hours.

3. Soldering Condition

3.1 Pb-free solder temperature profile

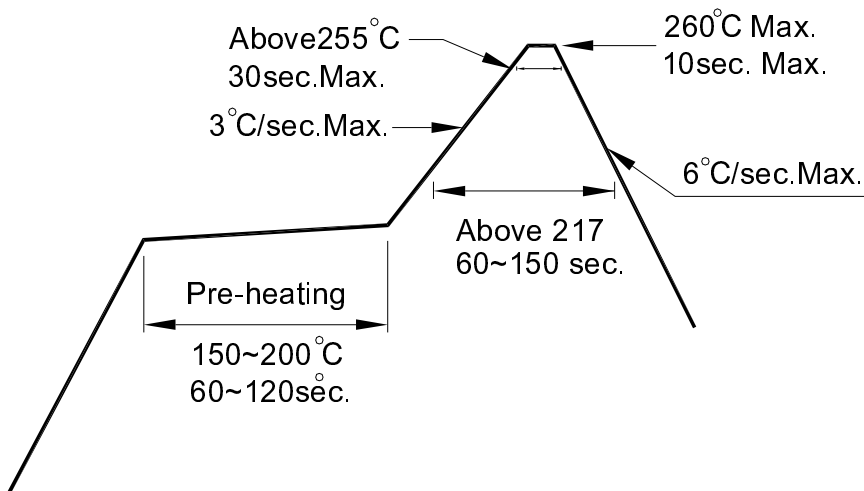

3.2 Reflow soldering should not be done more than two times.

3.3 When soldering, do not put stress on the LEDs during heating.

3.4 After soldering, do not warp the circuit board.

4. Soldering Iron

Each terminal is to go to the tip of soldering iron temperature less than 350°C for 3 seconds within once in less than the soldering iron capacity 25W. Leave two seconds and more intervals, and do soldering of each terminal. Be careful because the damage of the product is often started at the time of the hand solder.

5. Repairing

Repair should not be done after the LEDs have been soldered. When repairing is unavoidable, a double-head soldering iron should be used (as below figure). It should be confirmed beforehand whether the characteristics of the LEDs will or will not be damaged by repairing.

