

LC503QBL1-15G-A

Features

5mm Package
 High Luminous Intensity
 High Optical Power
 Lead Free
 Water Clear Lens
 This product has Stand-Offs



ATTENTION
 OBSERVE PRECAUTIONS
 ELECTROSTATIC
 SENSITIVE DEVICES

Applications

Decorative Lighting
 General Purpose Lighting
 Indoor Message Centers
 Instrumentation
 Medical Equipment

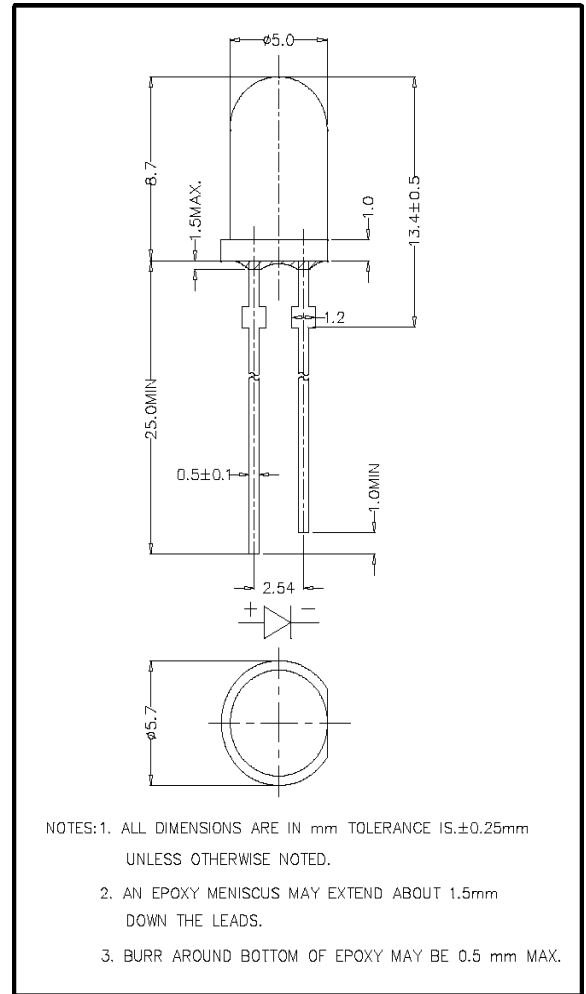

Maximum Ratings (Ta=25°C)

Characteristic	Symbol	Max.	Unit
Forward Current	I _F	25	mA
Reverse Voltage	V _R	5	V
Power Dissipation	P _D	105.00	mW
Operating Temperature	T _{opr}	-40 ~ +95	°C
Storage Temperature	T _{stg}	-40 ~ +100	°C
Soldering Temperature	T _{sol}	260	°C
Soldering Time	-	for 5 sec. max	-

Opto-Electrical Characteristics (Ta=25°C)

Characteristic	Symbol	Test Condition	Min	Typ	Max	Unit
Forward Voltage	V _F	I _F =20mA	-	3.60	4.20	V
Reverse Current	I _R	V _R =5V	-	-	100	μ A
Luminous Intensity	I _v	I _F =20mA	3000.00	7000.00	-	mcd
Viewing Angle	2θ ^{1/2}	-	-	15°	-	deg.
Peak Wavelength	λ _p	I _F =20mA	-	465	-	nm
Dominant Wavelength	λ _d	I _F =20mA	-	470	-	nm
Spectral Line Half Width	Δλ	I _F =20mA	-	28	-	nm

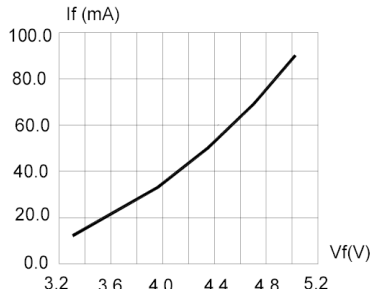

FIG.1 FORWARD CURRENT VS. FORWARD VOLTAGE.

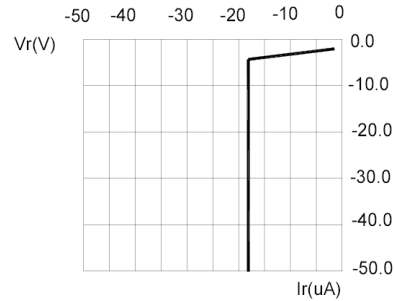

FIG.2 REVERSE CURRENT VS. REVERSE VOLTAGE.

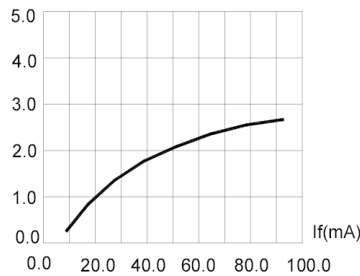

FIG.3 RELATIVE LUMINOUS INTENSITY VS. FORWARD CURRENT.

Half Power Δ WL=28nm
Domi WL= 470nm

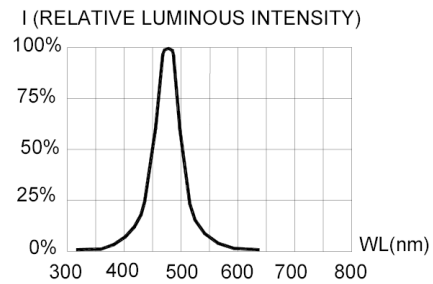

FIG.4 RELATIVE LUMINOUS INTENSITY VS. WAVELENGTH.

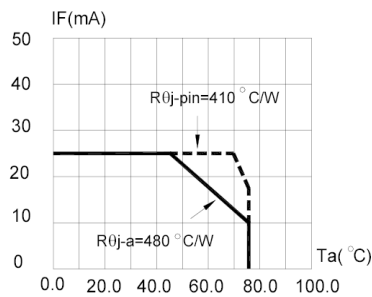

FIG.5 MAXIMUM FORWARD DC CURRENT VS AMBIENT TEMPERATURE (Tjmax=95°C)

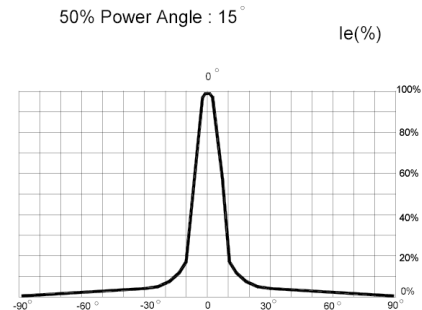

FIG.6 FAR FIELD PATTERN

1. Cathode PAD Area (0.18 X 0.18inch²)
2. Height above nominal seating plane in inches(0.3inch)