

RoHS Compliant & Pb-Free Product
Package Style: SOT 6-Lead

Features

- Low Noise and High Intercept Point
- Adjustable Bias Current
- Power Down Control
- Low Insertion Loss Bypass Feature
- 1.8V to 5V Operation (See Note: Page 2)
- 1.5GHz to 3.8GHz Operation

Applications

- WLAN LNA with Bypass Feature
- CDMA PCS LNA with Bypass Feature
- MMDS LNA with Bypass Feature
- General Purpose Amplification
- Commercial and Consumer Systems

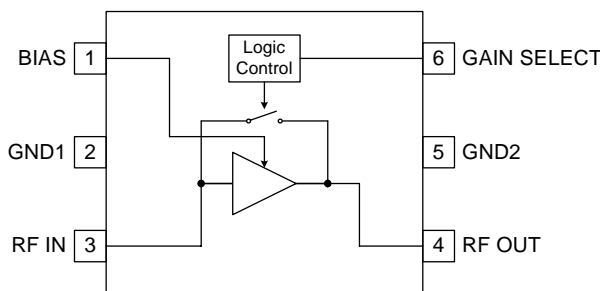

Functional Block Diagram

Product Description

The RF2370 is a switchable low noise amplifier with a very high dynamic range designed for digital cellular and WLAN applications. The device functions as an outstanding front end low noise amplifier. The bias current may be set externally. The IC is featured in a standard SOT 6-lead plastic package.

Ordering Information

RF2370	3V Low Noise Amplifier
RF2370PCBA-410	Fully Assembled Evaluation Board (WLAN) usable from 1.9GHz to 4 GHz with standard tune

Optimum Technology Matching® Applied

- | | | | |
|--|--------------------------------------|-------------------------------------|-----------------------------------|
| <input checked="" type="checkbox"/> GaAs HBT | <input type="checkbox"/> SiGe BiCMOS | <input type="checkbox"/> GaAs pHEMT | <input type="checkbox"/> GaN HEMT |
| <input type="checkbox"/> GaAs MESFET | <input type="checkbox"/> Si BiCMOS | <input type="checkbox"/> Si CMOS | |
| <input type="checkbox"/> InGaP HBT | <input type="checkbox"/> SiGe HBT | <input type="checkbox"/> Si BJT | |

RF MICRO DEVICES®, RFMD®, Optimum Technology Matching®, Enabling Wireless Connectivity™, PowerStar®, POLARIS™ TOTAL RADIO™ and UltimateBlue™ are trademarks of RFMD, LLC. BLUETOOTH is a trademark owned by Bluetooth SIG, Inc., U.S.A. and licensed for use by RFMD. All other trade names, trademarks and registered trademarks are the property of their respective owners. ©2006, RF Micro Devices, Inc.

Absolute Maximum Ratings

Parameter	Rating	Unit
Supply Voltage	-0.5 to +6.0	V _{DC}
Input RF Level	+5 (see note)	dBm
Current Drain, I _{CC}	32	mA
Operating Ambient Temperature	-40 to +85	°C
Storage Temperature	-40 to +150	°C

NOTE: Exceeding any one or a combination of the above maximum rating limits may cause permanent damage. Input RF transients to +15dBm will not harm the device. For sustained operation at inputs $\geq +5$ dBm, a small dropping resistor is recommended in series with the V_{CC} in order to limit the current due to self-biasing to <32mA.



Caution! ESD sensitive device.

Exceeding any one or a combination of the Absolute Maximum Rating conditions may cause permanent damage to the device. Extended application of Absolute Maximum Rating conditions to the device may reduce device reliability. Specified typical performance or functional operation of the device under Absolute Maximum Rating conditions is not implied.

RoHS status based on EU Directive 2002/95/EC (at time of this document revision).

The information in this publication is believed to be accurate and reliable. However, no responsibility is assumed by RF Micro Devices, Inc. ("RFMD") for its use, nor for any infringement of patents, or other rights of third parties, resulting from its use. No license is granted by implication or otherwise under any patent or patent rights of RFMD. RFMD reserves the right to change component circuitry, recommended application circuitry and specifications at any time without prior notice.

Parameter	Specification			Unit	Condition
	Min.	Typ.	Max.		
Operating Range					T _{AMB} = +25 °C, V _{CC} = 3.0V
Frequency Range	900		4000	MHz	
WLAN Low Noise Amplifier					
Frequency		2450		MHz	
HIGH GAIN MODE					Gain Select < 0.8V, V _{BIAS} = 3V, T = +25 °C
Gain	12.0	14.0		dB	
Noise Figure		1.3	1.5	dB	
Input IP3		+7.0		dBm	IIP3 will improve if ICC is raised above 7 mA.
Output VSWR		1.7:1	2:1		
Current Drain		7		mA	
BYPASS MODE					Gain Select > 1.8V, V _{BIAS} = 0V
Gain	-4.0	-3.0	-2.0	dB	Note: Bypass mode insertion loss will degrade gradually as V _{CC} goes below 2.7V.
Input IP3	+16.0	+20.0		dBm	
Output VSWR		1.6:1			
Current Drain		2.0	3.0	mA	
Power Supply					
Voltage (V _{CC})		3		V	
V _{SELECT} Low			0.8	V	High Gain mode. Select < 0.8V, V _{BIAS} = 3V
V _{SELECT} High	1.8			V	Low Gain mode. Select > 1.8V, V _{BIAS} = 0V
Power Down	0		10	µA	Gain Select < 0.8V, V _{BIAS} = 0V, V _{CC} = 3.0V

Bias note: Due to the presence of ESD protection circuitry on the RF2370, the maximum allowable collector bias voltage (pin 4) is 4.0V. Higher supply voltages such as 5V are permissible if a series resistor is used to drop V_{CC} to ≤ 4.0 V for a given I_{CC}.

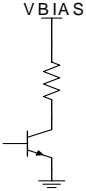
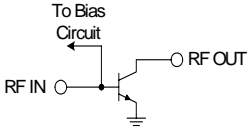
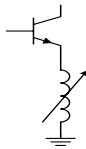
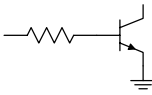
Pin	Function	Description	Interface Schematic
1	BIAS	For low noise amplifier applications, this pin is used to control the bias current. An external resistor can be used to set the bias current for any V_{BIAS} voltage.	
2	GND1	Ground connection. For best performance, keep traces physically short and connect immediately to ground plane.	
3	RF IN	RF input pin. This part is designed such that 50Ω is the optimal source impedance for best noise figure. Best noise figure is achieved with only a series capacitor on the input.	
4	RF OUT	Amplifier output pin. This pin is an open-collector output. It must be biased to V_{CC} through a choke or matching inductor. This pin is matched to 50Ω with a shunt L, series L topology enhances to stability of the device by reducing the high frequency gain above 6GHz.	
5	GND2	See GND1.	
6	GAIN SELECT	This pin selects high gain and bypass modes. Gain Select $\leq 0.8V$, high gain. Gain Select $\geq 1.8V$, low gain. A series resistor of 100Ω is required on this pin to enhance stability.	

Package Drawing

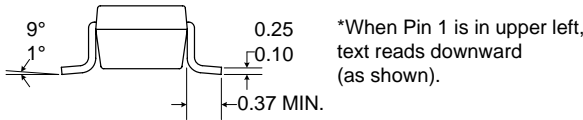
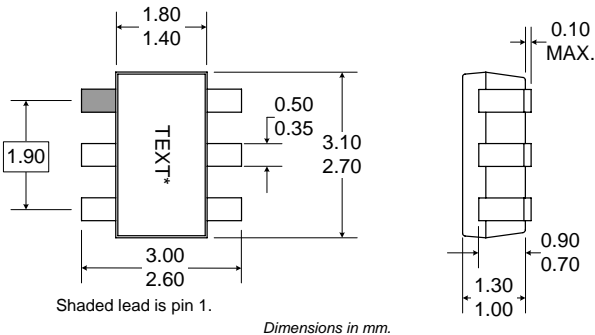

Evaluation Board Schematic

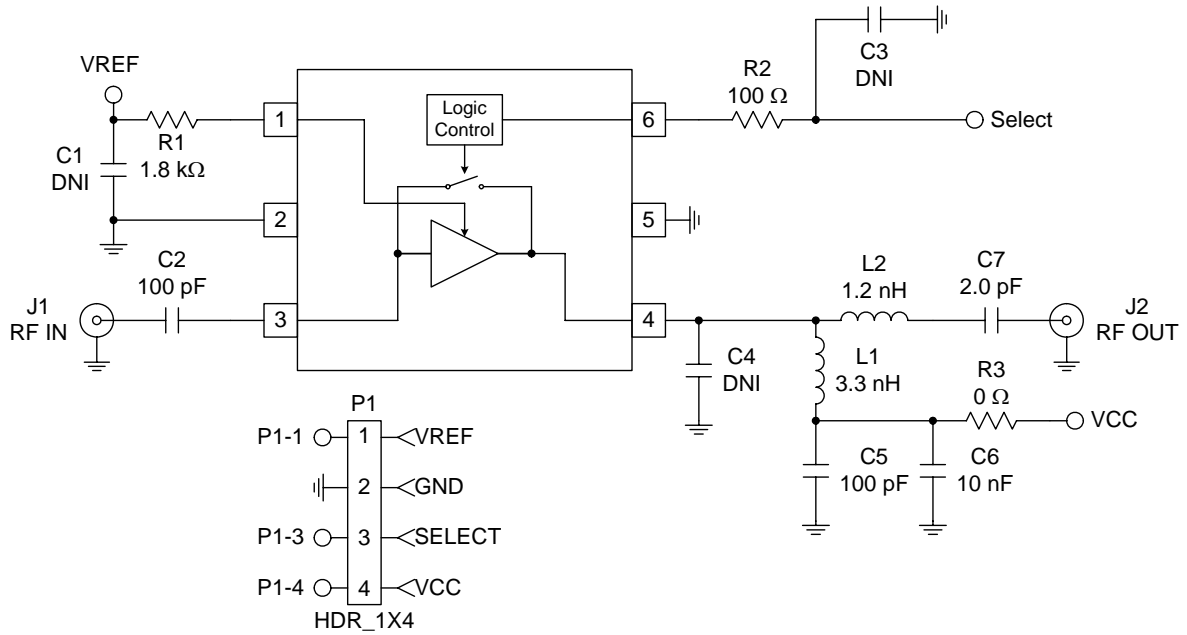

Evaluation Board Layout

Board Size 0.835" x 0.900"

Board Thickness 0.032", Board Material FR-4

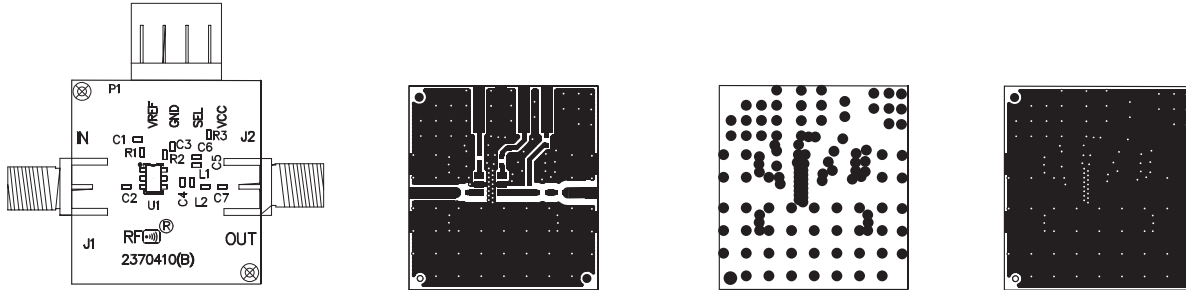

RoHS* Banned Material Content

RoHS Compliant:	Yes
Package total weight in grams (g):	0.013
Compliance Date Code:	N/A
Bill of Materials Revision:	-
Pb Free Category:	e3

Bill of Materials	Parts Per Million (PPM)					
	Pb	Cd	Hg	Cr VI	PBB	PBDE
Die	0	0	0	0	0	0
Molding Compound	0	0	0	0	0	0
Lead Frame	0	0	0	0	0	0
Die Attach Epoxy	0	0	0	0	0	0
Wire	0	0	0	0	0	0
Solder Plating	0	0	0	0	0	0

This RoHS banned material content declaration was prepared solely on information, including analytical data, provided to RFMD by its suppliers, and applies to the Bill of Materials (BOM) revision noted

* DIRECTIVE 2002/95/EC OF THE EUROPEAN PARLIAMENT AND OF THE COUNCIL of 27 January 2003 on the restriction of the use of certain hazardous substances in electrical and electronic equipment