

NANOPOWER 1.8-V SOT23 COMPARATORS WITH VOLTAGE REFERENCE

FEATURES

- **Controlled Baseline**
 - One Assembly/Test Site
 - One Fabrication Site
- **Extended Temperature Performance of –55°C to 125°C**
- **Enhanced Diminishing Manufacturing Sources (DMS) Support**
- **Enhanced Product-Change Notification**
- **Qualification Pedigree⁽¹⁾**
- **Low Quiescent Current = 5 μ A (Max)**
- **Integrated Voltage Reference = 1.242 V**
- **Input Common-Mode Range = 200 mV Beyond Rails**
- **Voltage Reference Initial Accuracy = 1%**
- **Open-Drain Logic Compatible Output (TLV3011)**
- **Push-Pull Output (TLV3012)**
- **Low Supply Voltage = 1.8 V to 5.5 V**
- **Fast Response Time = 6- μ s Propagation Delay With 100-mV Overdrive (TLV3011: R_{PULLUP} = 10 k Ω)**
- **Microsize Package: SOT23-6**

(1) Component qualification in accordance with JEDEC and industry standards to ensure reliable operation over an extended temperature range. This includes, but is not limited to, Highly Accelerated Stress Test (HAST) or biased 85/85, temperature cycle, autoclave or unbiased HAST, electromigration, bond intermetallic life, and mold compound life. Such qualification testing should not be viewed as justifying use of this component beyond specified performance and environmental limits.

APPLICATIONS

- **Battery-Powered Level Detection**
- **Data Acquisition**
- **System Monitoring**
- **Oscillators**
- **Sensor Systems**
 - Smoke Detectors
 - Light Sensors
 - Alarms

DESCRIPTION

The TLV3011 and TLV3012 are low-power, open-drain output comparators. The devices feature an uncommitted on-chip voltage reference, have 5- μ A (max) quiescent current, input common-mode range 200 mV beyond the supply rails, and single-supply operation from 1.8 V to 5.5 V. The integrated 1.242-V series voltage reference offers low 100-ppm/ $^{\circ}$ C (max) drift, is stable with up to 10-nF capacitive load, and can provide up to 0.5 mA (typ) of output current.

The TLV3011 and TLV3012 are available in the tiny SOT23-6 package for space-conservative designs. The devices are specified for the temperature range of –55°C to 125°C.

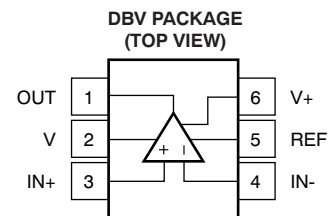

Please be aware that an important notice concerning availability, standard warranty, and use in critical applications of Texas Instruments semiconductor products and disclaimers thereto appears at the end of this data sheet.



This integrated circuit can be damaged by ESD. Texas Instruments recommends that all integrated circuits be handled with appropriate precautions. Failure to observe proper handling and installation procedures can cause damage.

ESD damage can range from subtle performance degradation to complete device failure. Precision integrated circuits may be more susceptible to damage because very small parametric changes could cause the device not to meet its published specifications.

PACKAGE ORDERING INFORMATION

T _A	PACKAGE ⁽¹⁾	ORDERABLE PART NUMBER	TOP SIDE MARKING
-55°C TO 125°C	DBV-SOT	TLV3011AMDBVREP	BTV
	DBV-SOT	TLV3012AMDBVREP ⁽²⁾	TBD

(1) Package drawings, standard packing quantities, thermal data, symbolization, and PCB design guidelines are available at www.ti.com/sc/package.

(2) Product Preview

Pin Configurations

Top View

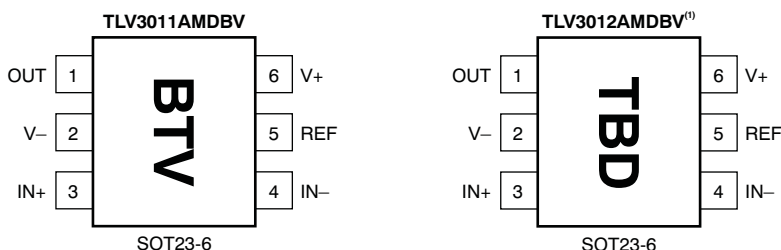

Note: Pin 1 is determined by orienting package marking as shown.

⁽¹⁾ Product Preview

ABSOLUTE MAXIMUM RATINGS⁽¹⁾

over operating free-air temperature range (unless otherwise noted)

		MIN	MAX	UNIT
Supply voltage			7	V
Signal input terminals	Voltage ⁽²⁾	-0.5	(V+) +0.5	V
	Current ⁽²⁾		±10	mA
Output short circuit ⁽³⁾			Continuous	
Operating temperature range		-55	125	°C
T _{stg}	Storage temperature range	-65	150	°C
T _j	Junction temperature		150	°C
Lead ambient temperature (soldering, 10 s)			300	°C
ESD rating (Human-Body Model)			2000	V

(1) Stresses beyond those listed under "absolute maximum ratings" may cause permanent damage to the device. These are stress ratings only, and functional operation of the device at these or any other conditions beyond those indicated under "recommended operating conditions" is not implied. Exposure to absolute-maximum-rated conditions for extended periods may affect device reliability.

(2) All voltage values are with respect to the network ground terminal.

(3) Short circuit to ground

ELECTRICAL CHARACTERISTICS

over operating free-air temperature range (unless otherwise noted)

PARAMETER		TEST CONDITIONS	MIN	TYP	MAX	UNIT
Offset Voltage						
V_{OS}	Input offset voltage	$V_{CM} = 0\text{ V}$, $I_O = 0\text{ V}$		0.5	15	mV
dV_{OS}/dT	Input offset voltage vs temperature	$T_A = -55^\circ\text{C}$ to 125°C		± 12		$\mu\text{V}/^\circ\text{C}$
PSRR	Power supply rejection ratio	$V_S = 1.8\text{ V}$ to 5.5 V		100	1000	$\mu\text{V}/\text{V}$
Input Bias Current						
I_S	Input bias current	$V_{CM} = V_S/2$		± 10		pA
I_{OS}	Input offset current	$V_{CM} = V_S/2$		± 10		pA
Input Voltage Range						
V_{CM}	Common-mode voltage range		$(V_-) - 0.2$		$(V_+) + 0.2$	V
CMRR	Common-mode rejection ratio	$V_{CM} = -0.2\text{ V}$ to $(V_+) - 1.5\text{ V}$	60	74		dB
		$V_{CM} = -0.2\text{ V}$ to $(V_+) + 0.2\text{ V}$	54	62		
Input Impedance						
	Common mode			$10^{13} \parallel 2$		$\Omega \parallel \text{pF}$
	Differential			$10^{13} \parallel 4$		$\Omega \parallel \text{pF}$
Switching Characteristics						
Propagation delay time	Low to high	$f = 10\text{ kHz}$, $V_{STEP} = 1\text{ V}$, input overdrive = 10 mV		12		μs
		$f = 10\text{ kHz}$, $V_{STEP} = 1\text{ V}$, input overdrive = 100 mV		6		
	High to low	$f = 10\text{ kHz}$, $V_{STEP} = 1\text{ V}$, input overdrive = 10 mV		13.5		
		$f = 10\text{ kHz}$, $V_{STEP} = 1\text{ V}$, input overdrive = 100 mV		6.5		
t_r	Rise time	TLV3011		See ⁽¹⁾		
		TLV3012 ⁽²⁾	$C_L = 10\text{ pF}$	100		ns
t_f	Fall time		$C_L = 10\text{ pF}$	100		ns
Output						
V_{OL}	Voltage output low from rail	$V_S = 5\text{ V}$		160	200	mV
	Voltage output high from rail	TLV3012 ⁽²⁾	$I_{OUT} = -5\text{ mA}$	90	200	mV
	Short-circuit current	TLV3012 ⁽²⁾	$I_{OUT} = 5\text{ mA}$	See Typical Characteristics		
Voltage Reference						
V_{OUT}	Output voltage		1.208	1.242	1.276	V
	Initial accuracy				$\pm 1\%$	
dV_{OUT}/dT	Temperature drift	$-55^\circ\text{C} \leq T_A \leq 125^\circ\text{C}$		40	100	ppm/ $^\circ\text{C}$
dV_{OUT}/dI_{LOAD}	Load regulation	Sourcing	$0\text{ mA} < I_{SOURCE} \leq 0.5\text{ mA}$	0.36	1	mV/mA
		Sinking	$0\text{ mA} < I_{SINK} \leq 0.5\text{ mA}$	6.6		
I_{LOAD}	Output current			0.5		mA
dV_{OUT}/dV_{IN}	Line regulation	$1.8\text{ V} \leq V_{IN} \leq 5.5\text{ V}$		10	100	$\mu\text{V}/\text{V}$
Noise						
	Reference voltage noise	$f = 0.1\text{ Hz}$ to 10 Hz		0.2		mV _{PP}
Power Supply						
V_S	Specified voltage		1.8		5.5	V
	Operating voltage range		1.8		5.5	V
I_Q	Quiescent current	$V_S = 5\text{ V}$, $V_O = \text{High}$		2.8	5	μA

(1) t_r dependent on R_{PULLUP} and C_{LOAD} .

(2) Product Preview

ELECTRICAL CHARACTERISTICS (continued)

over operating free-air temperature range (unless otherwise noted)

PARAMETER		TEST CONDITIONS	MIN	TYP	MAX	UNIT
Temperature						
Operating range			-55		125	°C
Storage range			-65		150	°C
Thermal resistance	SOT23-6			200		°C/W

TYPICAL CHARACTERISTICS

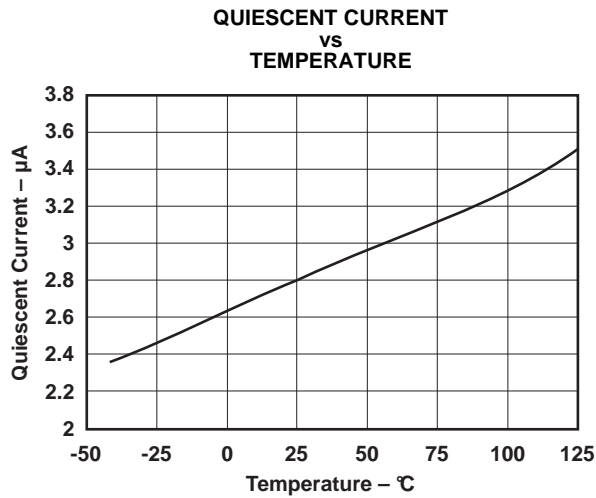

Figure 1.

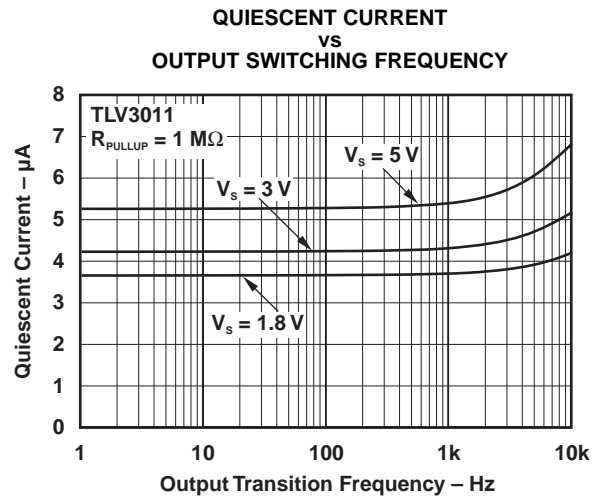

Figure 2.

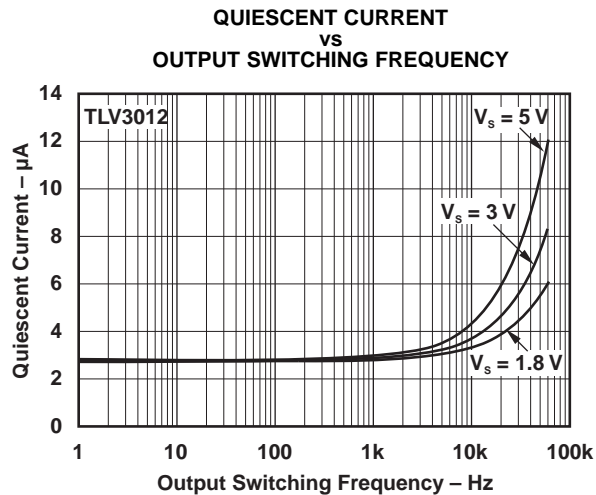

Figure 3.

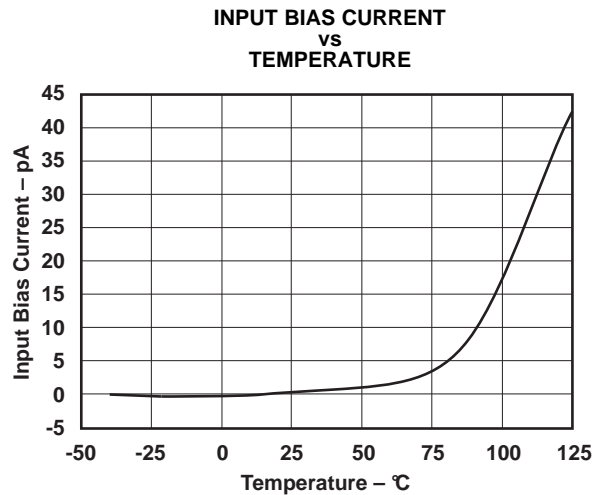

Figure 4.

TYPICAL CHARACTERISTICS (continued)

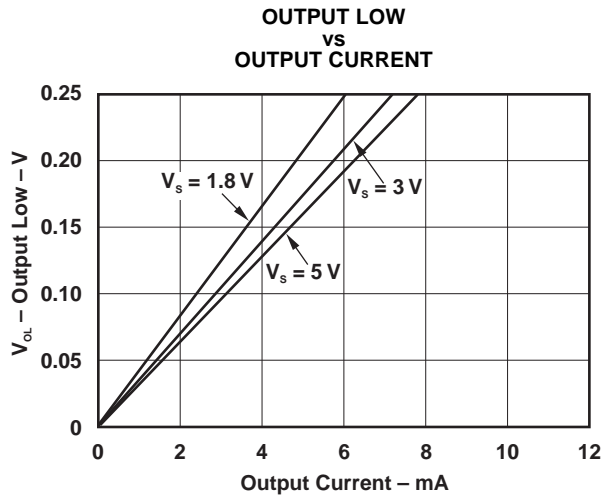

Figure 5.

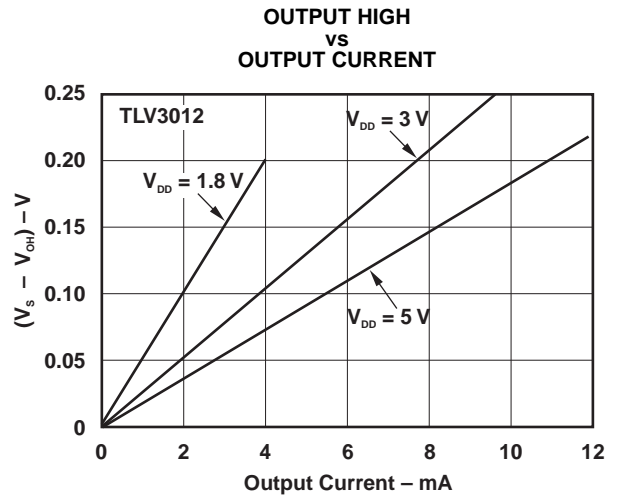

Figure 6.

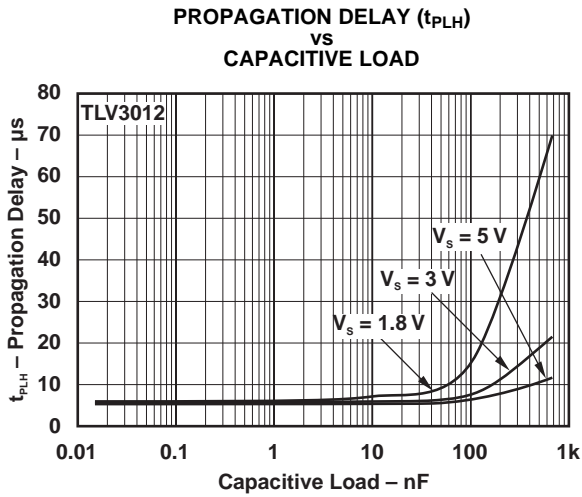

Figure 7.

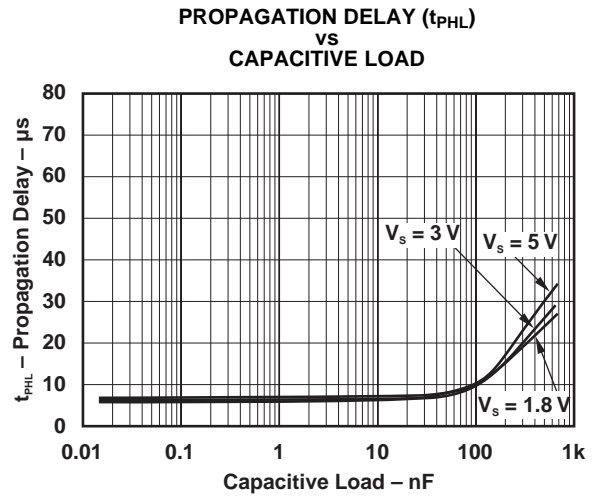

Figure 8.

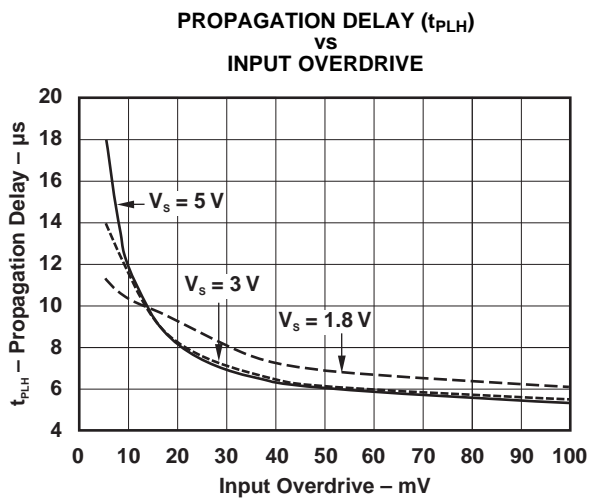

Figure 9.

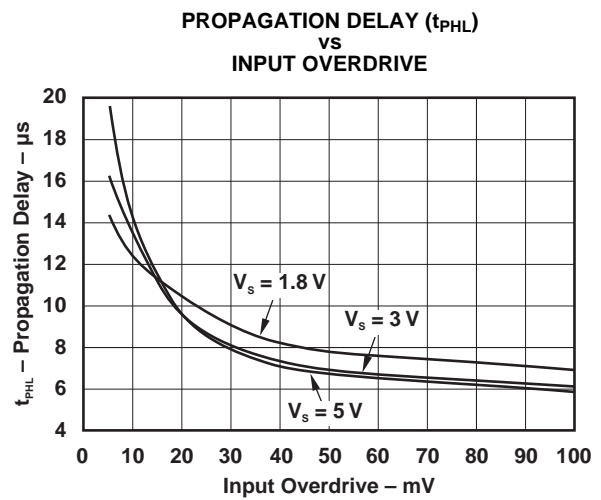

Figure 10.

TYPICAL CHARACTERISTICS (continued)

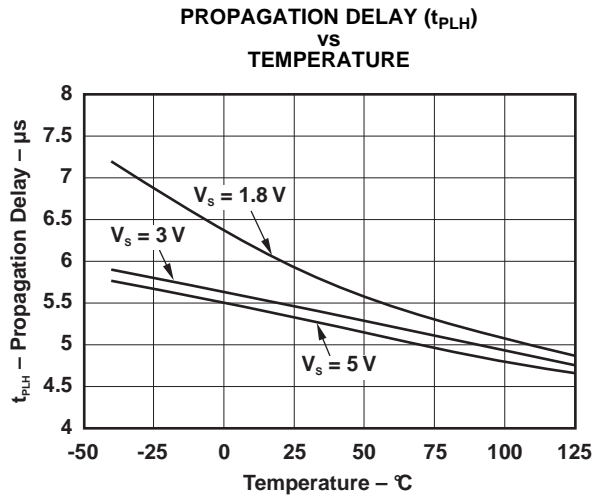

Figure 11.

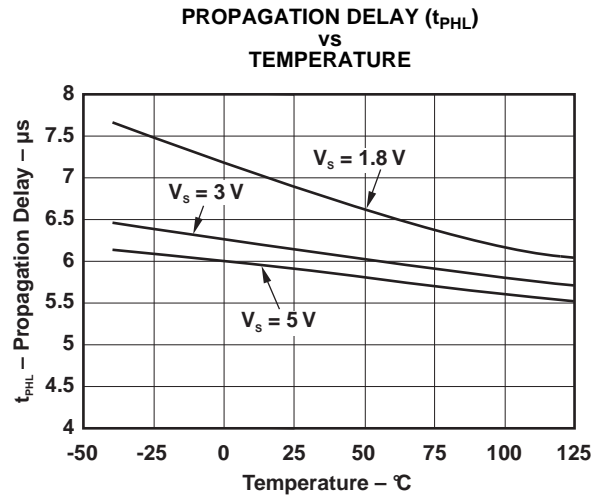

Figure 12.

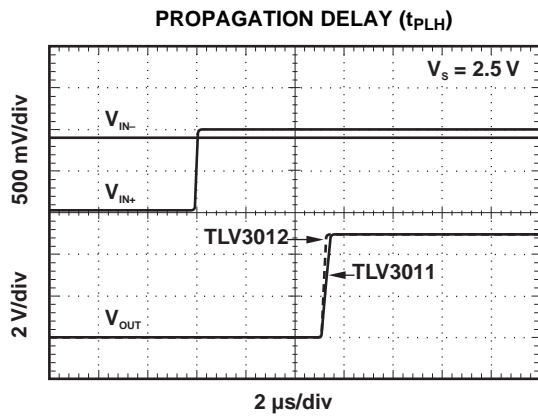

Figure 13.

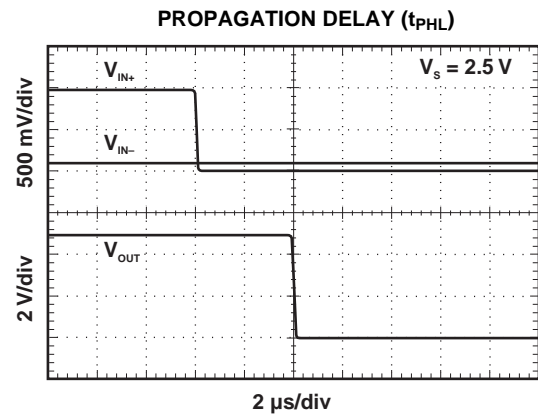

Figure 14.

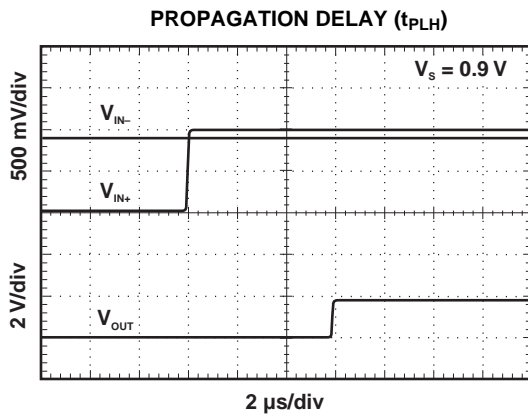

Figure 15.

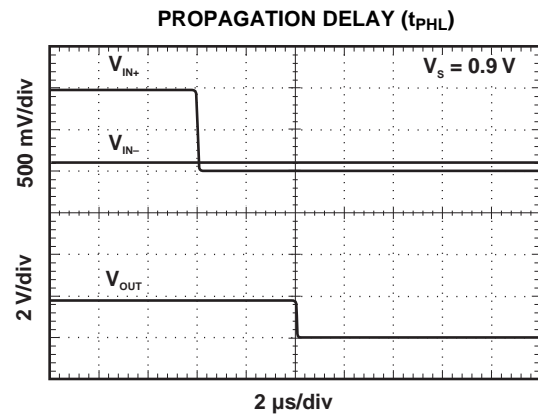

Figure 16.

TYPICAL CHARACTERISTICS (continued)

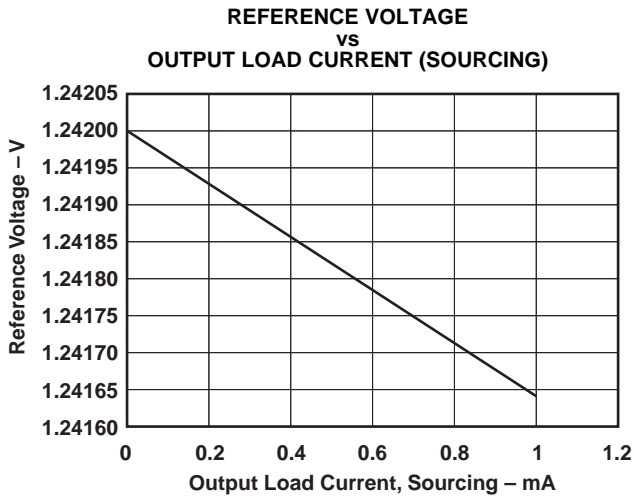

Figure 17.

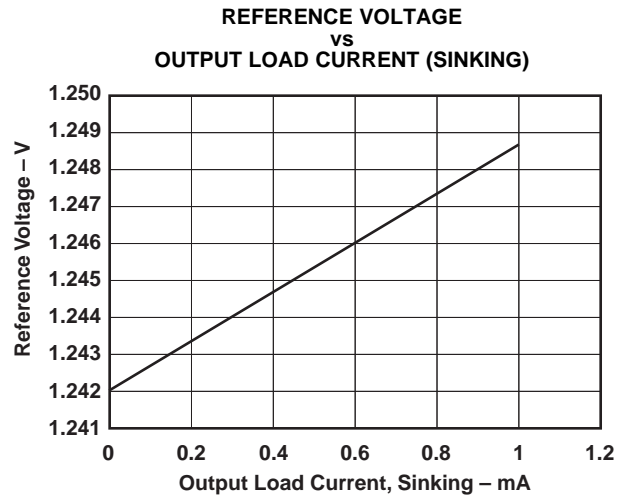

Figure 18.

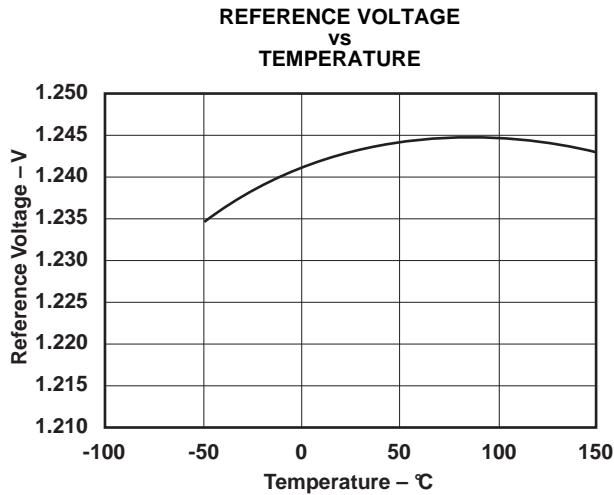

Figure 19.

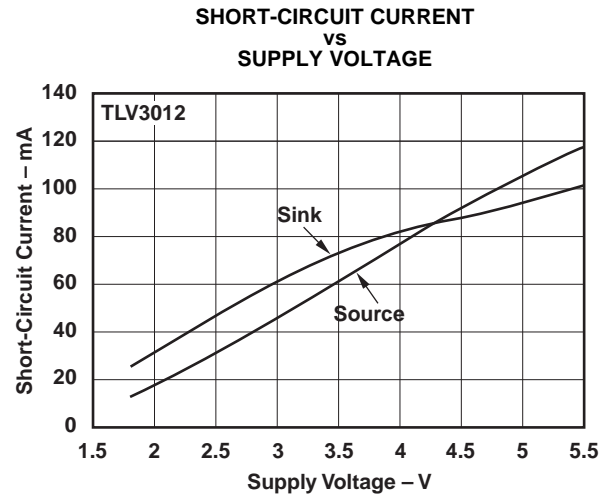

Figure 20.

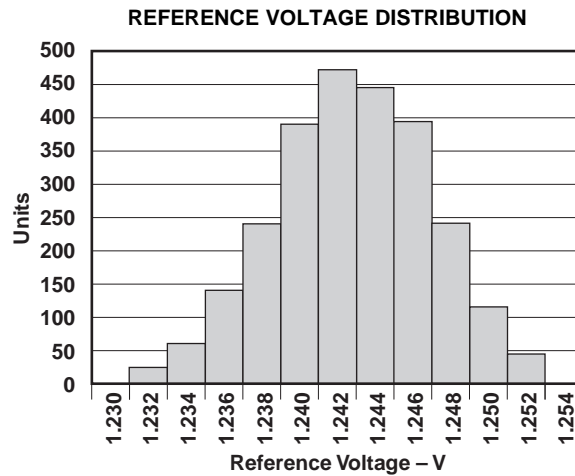

Figure 21.

APPLICATION INFORMATION

The TLV3011 is a low-power, open-drain comparator with on-chip 1.242-V series reference. The open-drain output allows multiple devices to be driven by a single pullup resistor to accomplish an OR function, making the TLV3011 useful for logic applications.

The TLV3012 comparator with on-chip 1.242-V series reference has a push-pull output stage optimal for reduced power budget applications and features no shoot-through current.

A typical supply current of 2.8 μA and small packaging combine with 1.8-V supply requirements to make the TLV3011 and TLV3012 optimal for battery and portable designs.

Board Layout

Typical connections for the TLV3011 and TLV3012 are shown in Figure 22. The TLV3011 is an open-drain output device. A pullup resistor must be connected between the comparator output and supply to enable operation.

To minimize supply noise, power supplies should be capacitively decoupled by a 0.01- μF ceramic capacitor in parallel with a 1- μF electrolytic capacitor. Comparators are sensitive to input noise and precautions such as proper grounding (use of ground plane), supply bypassing, and guarding of high-impedance nodes minimize the effects of noise and help to ensure specified performance.

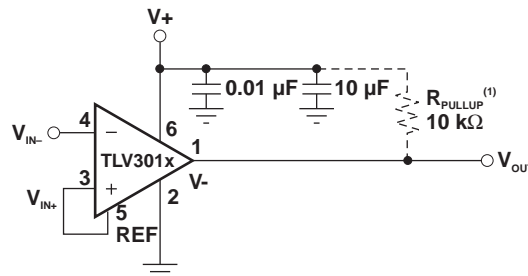

(1) Use R_{PULLUP} with the TLV3011 only.

Figure 22. Basic Connections of the TLV3011 and TLV3012

Open-Drain Output (TLV3011)

The open-drain output of the TLV3011 is useful in logic applications. The value of the pullup resistor and supply voltage used affects current consumption due to additional current drawn when the output is in a low state. This effect can be seen in Figure 3.

External Hysteresis

Comparator inputs have no noise immunity within the range of specified offset voltage (± 12 mV). For noisy input signals, the comparator output may display multiple switching as input signals move through the switching threshold. The typical comparator threshold of the TLV3011 and TLV3012 is ± 0.5 mV. To prevent multiple switching within the comparator threshold of the TLV3011 or TLV3012, external hysteresis may be added by connecting a small amount of feedback to the positive input. Figure 23 shows a typical topology used to introduce hysteresis, described by this equation:

$$V_{\text{HYST}} = \frac{V_+ \times R_1}{R_1 + R_2}$$

APPLICATION INFORMATION (continued)

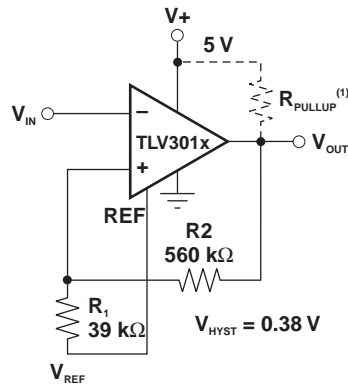

(1) Use R_{PULLUP} with the TLV3011 only.

Figure 23. Adding Hysteresis

V_{HYST} sets the value of the transition voltage required to switch the comparator output by increasing the threshold region, thereby reducing sensitivity to noise.

Applications

Battery-Level Detect

The low power consumption and 1.8-V supply voltage of the TLV3011 make it an excellent candidate for battery-powered applications. Figure 24 shows the TLV3011 configured as a low battery level detector for a 3-V battery.

$$\text{Battery Okay trip voltage} = 1.242 \frac{R_1 + R_2}{R_2}$$

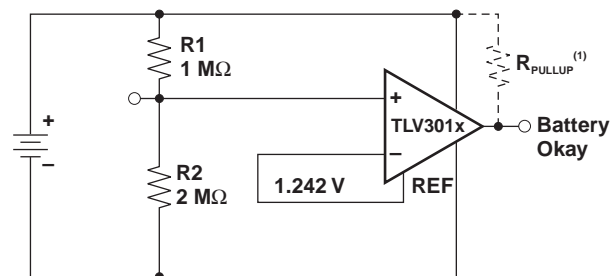

When the battery voltage drops below 1.9 V, the Battery Okay output goes low.

(1) Use R_{PULLUP} with the TLV3011 only.

Figure 24. TLV3011 Configured as Low Battery Level Detector

APPLICATION INFORMATION (continued)

Power-On Reset

The reset circuit shown in Figure 25 provides a time-delayed release of reset to the MSP430 microcontroller. Operation of the circuit is based on a stabilization time constant of the supply voltage, rather than on a predetermined voltage value. The negative input is a reference voltage created by the internal voltage reference. The positive input is an RC circuit that provides a power-up delay. When power is applied, the output of the comparator is low, holding the processor in the reset condition. Only after allowing time for the supply voltage to stabilize does the positive input of the comparator become higher than the negative input, resulting in a high output state, releasing the processor for operation. The stabilization time required for the supply voltage is adjustable by the selection of the RC component values. Use of a lower-valued resistor in this portion of the circuit does not increase current consumption, because no current flows through the RC circuit after the supply has stabilized.

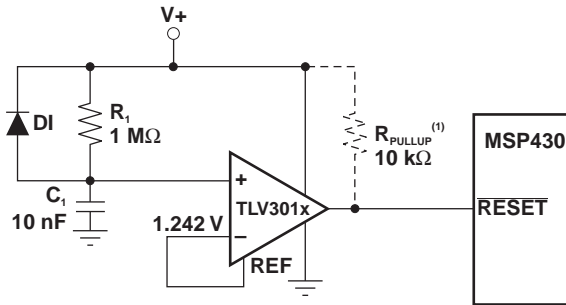

(1) Use R_{PULLUP} with the TLV3011 only.

Figure 25. TLV3011 or TLV3012 Configured as Power-Up Reset Circuit for the MSP430

The reset delay needed depends on the power-up characteristics of the system power supply. R_1 and C_1 are selected to allow enough time for the power supply to stabilize. D_1 provides rapid reset if power is lost. In this example, the $R_1 \times C_1$ time constant is 10 ms.

Relaxation Oscillator

The TLV3012 can be configured as a relaxation oscillator to provide a simple and inexpensive clock output (see Figure 26). The capacitor is charged at a rate of $T = 0.69RC$ and discharges at a rate of $0.69RC$. Therefore, the period is $T = 1.38RC$. R_1 may be a different value than R_2 .

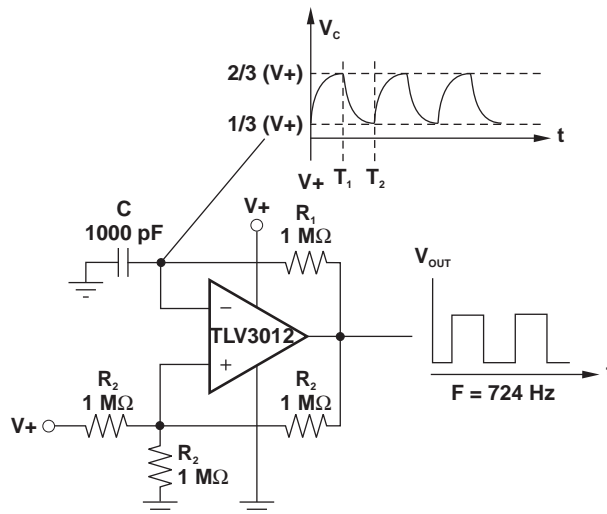

Figure 26. TLV3012 Configured as Relaxation Oscillator

PACKAGING INFORMATION

Orderable Device	Status (1)	Package Type	Package Drawing	Pins	Package Qty	Eco Plan (2)	Lead/Ball Finish	MSL Peak Temp (3)	Op Temp (°C)	Top-Side Markings (4)	Samples
TLV3011AMDBVREP	ACTIVE	SOT-23	DBV	6	3000	Green (RoHS & no Sb/Br)	CU NIPDAU	Level-1-260C-UNLIM	-55 to 125	BTV	Samples
V62/07604-01XE	ACTIVE	SOT-23	DBV	6	3000	Green (RoHS & no Sb/Br)	CU NIPDAU	Level-1-260C-UNLIM	-55 to 125	BTV	Samples

(1) The marketing status values are defined as follows:

ACTIVE: Product device recommended for new designs.

LIFEBUY: TI has announced that the device will be discontinued, and a lifetime-buy period is in effect.

NRND: Not recommended for new designs. Device is in production to support existing customers, but TI does not recommend using this part in a new design.

PREVIEW: Device has been announced but is not in production. Samples may or may not be available.

OBsolete: TI has discontinued the production of the device.

(2) Eco Plan - The planned eco-friendly classification: Pb-Free (RoHS), Pb-Free (RoHS Exempt), or Green (RoHS & no Sb/Br) - please check <http://www.ti.com/productcontent> for the latest availability information and additional product content details.

TBD: The Pb-Free/Green conversion plan has not been defined.

Pb-Free (RoHS): TI's terms "Lead-Free" or "Pb-Free" mean semiconductor products that are compatible with the current RoHS requirements for all 6 substances, including the requirement that lead not exceed 0.1% by weight in homogeneous materials. Where designed to be soldered at high temperatures, TI Pb-Free products are suitable for use in specified lead-free processes.

Pb-Free (RoHS Exempt): This component has a RoHS exemption for either 1) lead-based flip-chip solder bumps used between the die and package, or 2) lead-based die adhesive used between the die and leadframe. The component is otherwise considered Pb-Free (RoHS compatible) as defined above.

Green (RoHS & no Sb/Br): TI defines "Green" to mean Pb-Free (RoHS compatible), and free of Bromine (Br) and Antimony (Sb) based flame retardants (Br or Sb do not exceed 0.1% by weight in homogeneous material)

(3) MSL, Peak Temp. -- The Moisture Sensitivity Level rating according to the JEDEC industry standard classifications, and peak solder temperature.

(4) Multiple Top-Side Markings will be inside parentheses. Only one Top-Side Marking contained in parentheses and separated by a "~" will appear on a device. If a line is indented then it is a continuation of the previous line and the two combined represent the entire Top-Side Marking for that device.

Important Information and Disclaimer: The information provided on this page represents TI's knowledge and belief as of the date that it is provided. TI bases its knowledge and belief on information provided by third parties, and makes no representation or warranty as to the accuracy of such information. Efforts are underway to better integrate information from third parties. TI has taken and continues to take reasonable steps to provide representative and accurate information but may not have conducted destructive testing or chemical analysis on incoming materials and chemicals. TI and TI suppliers consider certain information to be proprietary, and thus CAS numbers and other limited information may not be available for release.

In no event shall TI's liability arising out of such information exceed the total purchase price of the TI part(s) at issue in this document sold by TI to Customer on an annual basis.

OTHER QUALIFIED VERSIONS OF TLV3011-EP :

- Catalog: [TLV3011](#)

NOTE: Qualified Version Definitions:

- Catalog - TI's standard catalog product

TAPE AND REEL INFORMATION



QUADRANT ASSIGNMENTS FOR PIN 1 ORIENTATION IN TAPE



*All dimensions are nominal

Device	Package Type	Package Drawing	Pins	SPQ	Reel Diameter (mm)	Reel Width W1 (mm)	A0 (mm)	B0 (mm)	K0 (mm)	P1 (mm)	W (mm)	Pin1 Quadrant
TLV3011AMDBVREP	SOT-23	DBV	6	3000	179.0	8.4	3.2	3.2	1.4	4.0	8.0	Q3

TAPE AND REEL BOX DIMENSIONS



*All dimensions are nominal

Device	Package Type	Package Drawing	Pins	SPQ	Length (mm)	Width (mm)	Height (mm)
TLV3011AMDBVREP	SOT-23	DBV	6	3000	203.0	203.0	35.0

MECHANICAL DATA

DBV (R-PDSO-G6)

PLASTIC SMALL-OUTLINE PACKAGE

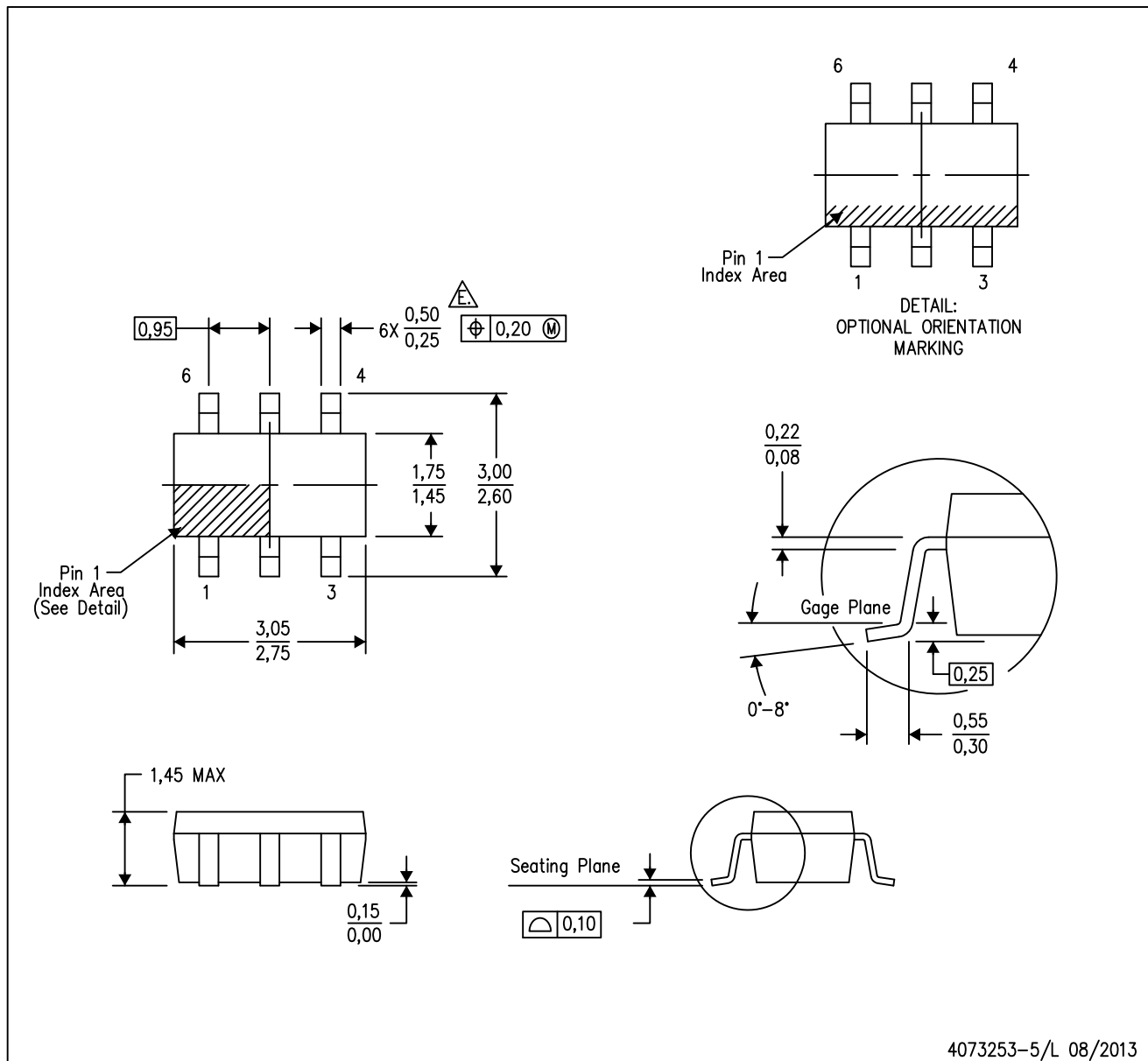

- NOTES:
- All linear dimensions are in millimeters.
 - This drawing is subject to change without notice.
 - Body dimensions do not include mold flash or protrusion. Mold flash and protrusion shall not exceed 0.15 per side.
 - Leads 1,2,3 may be wider than leads 4,5,6 for package orientation.
- Falls within JEDEC MO-178 Variation AB, except minimum lead width.

DBV (R-PDSO-G6)

PLASTIC SMALL OUTLINE

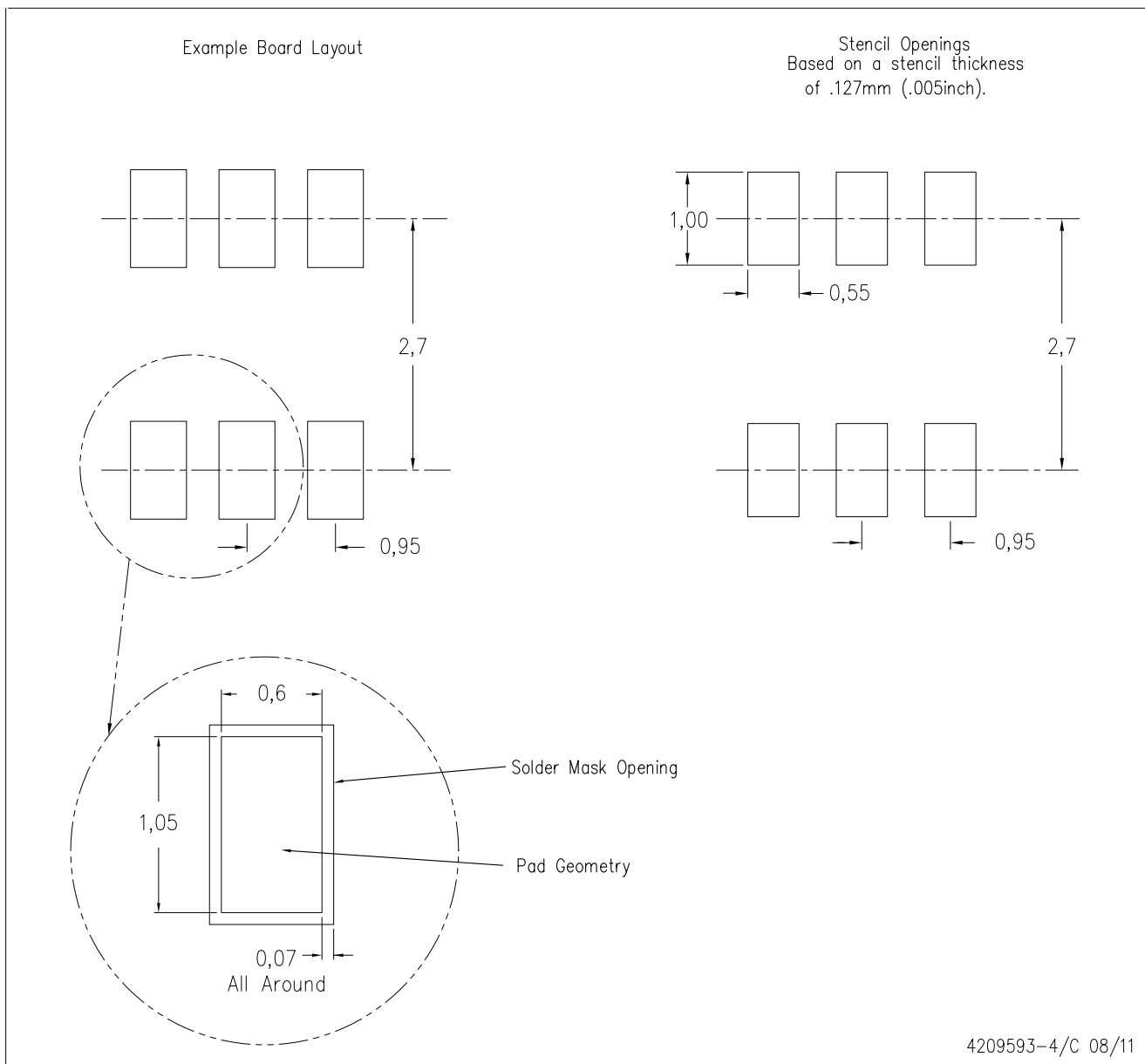

4209593-4/C 08/11

- NOTES:
- A. All linear dimensions are in millimeters.
 - B. This drawing is subject to change without notice.
 - C. Customers should place a note on the circuit board fabrication drawing not to alter the center solder mask defined pad.
 - D. Publication IPC-7351 is recommended for alternate designs.
 - E. Laser cutting apertures with trapezoidal walls and also rounding corners will offer better paste release. Customers should contact their board assembly site for stencil design recommendations. Example stencil design based on a 50% volumetric metal load solder paste. Refer to IPC-7525 for other stencil recommendations.

DCK (R-PDSO-G6)

PLASTIC SMALL-OUTLINE PACKAGE

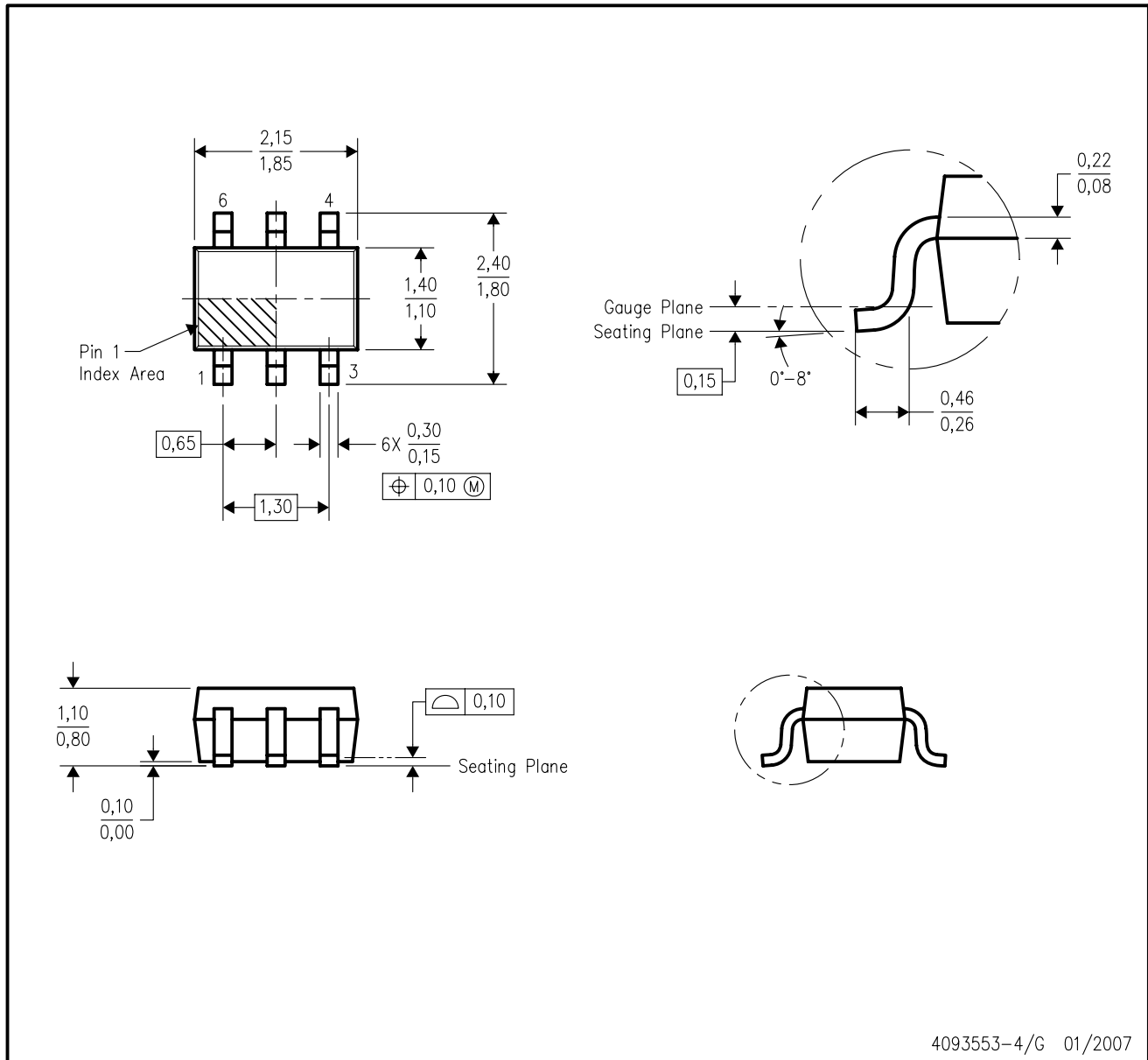

- NOTES:
- A. All linear dimensions are in millimeters.
 - B. This drawing is subject to change without notice.
 - C. Body dimensions do not include mold flash or protrusion. Mold flash and protrusion shall not exceed 0.15 per side.
 - D. Falls within JEDEC MO-203 variation AB.

IMPORTANT NOTICE

Texas Instruments Incorporated and its subsidiaries (TI) reserve the right to make corrections, enhancements, improvements and other changes to its semiconductor products and services per JESD46, latest issue, and to discontinue any product or service per JESD48, latest issue. Buyers should obtain the latest relevant information before placing orders and should verify that such information is current and complete. All semiconductor products (also referred to herein as "components") are sold subject to TI's terms and conditions of sale supplied at the time of order acknowledgment.

TI warrants performance of its components to the specifications applicable at the time of sale, in accordance with the warranty in TI's terms and conditions of sale of semiconductor products. Testing and other quality control techniques are used to the extent TI deems necessary to support this warranty. Except where mandated by applicable law, testing of all parameters of each component is not necessarily performed.

TI assumes no liability for applications assistance or the design of Buyers' products. Buyers are responsible for their products and applications using TI components. To minimize the risks associated with Buyers' products and applications, Buyers should provide adequate design and operating safeguards.

TI does not warrant or represent that any license, either express or implied, is granted under any patent right, copyright, mask work right, or other intellectual property right relating to any combination, machine, or process in which TI components or services are used. Information published by TI regarding third-party products or services does not constitute a license to use such products or services or a warranty or endorsement thereof. Use of such information may require a license from a third party under the patents or other intellectual property of the third party, or a license from TI under the patents or other intellectual property of TI.

Reproduction of significant portions of TI information in TI data books or data sheets is permissible only if reproduction is without alteration and is accompanied by all associated warranties, conditions, limitations, and notices. TI is not responsible or liable for such altered documentation. Information of third parties may be subject to additional restrictions.

Resale of TI components or services with statements different from or beyond the parameters stated by TI for that component or service voids all express and any implied warranties for the associated TI component or service and is an unfair and deceptive business practice. TI is not responsible or liable for any such statements.

Buyer acknowledges and agrees that it is solely responsible for compliance with all legal, regulatory and safety-related requirements concerning its products, and any use of TI components in its applications, notwithstanding any applications-related information or support that may be provided by TI. Buyer represents and agrees that it has all the necessary expertise to create and implement safeguards which anticipate dangerous consequences of failures, monitor failures and their consequences, lessen the likelihood of failures that might cause harm and take appropriate remedial actions. Buyer will fully indemnify TI and its representatives against any damages arising out of the use of any TI components in safety-critical applications.

In some cases, TI components may be promoted specifically to facilitate safety-related applications. With such components, TI's goal is to help enable customers to design and create their own end-product solutions that meet applicable functional safety standards and requirements. Nonetheless, such components are subject to these terms.

No TI components are authorized for use in FDA Class III (or similar life-critical medical equipment) unless authorized officers of the parties have executed a special agreement specifically governing such use.

Only those TI components which TI has specifically designated as military grade or "enhanced plastic" are designed and intended for use in military/aerospace applications or environments. Buyer acknowledges and agrees that any military or aerospace use of TI components which have **not** been so designated is solely at the Buyer's risk, and that Buyer is solely responsible for compliance with all legal and regulatory requirements in connection with such use.

TI has specifically designated certain components as meeting ISO/TS16949 requirements, mainly for automotive use. In any case of use of non-designated products, TI will not be responsible for any failure to meet ISO/TS16949.

Products

Audio	www.ti.com/audio
Amplifiers	amplifier.ti.com
Data Converters	dataconverter.ti.com
DLP® Products	www.dlp.com
DSP	dsp.ti.com
Clocks and Timers	www.ti.com/clocks
Interface	interface.ti.com
Logic	logic.ti.com
Power Mgmt	power.ti.com
Microcontrollers	microcontroller.ti.com
RFID	www.ti-rfid.com
OMAP Applications Processors	www.ti.com/omap
Wireless Connectivity	www.ti.com/wirelessconnectivity

Applications

Automotive and Transportation	www.ti.com/automotive
Communications and Telecom	www.ti.com/communications
Computers and Peripherals	www.ti.com/computers
Consumer Electronics	www.ti.com/consumer-apps
Energy and Lighting	www.ti.com/energy
Industrial	www.ti.com/industrial
Medical	www.ti.com/medical
Security	www.ti.com/security
Space, Avionics and Defense	www.ti.com/space-avionics-defense
Video and Imaging	www.ti.com/video

TI E2E Community

e2e.ti.com

Mouser Electronics

Authorized Distributor

Click to View Pricing, Inventory, Delivery & Lifecycle Information:

[Texas Instruments:](#)

[V62/07604-01XE](#) [TLV3011AMDBVREP](#)