



QL85H6S-A/B/C

◆ OVERVIEW

QL85H6SA is a MOCVD grown 850nm band AlGaAs laser diode with quantum well structure. It's an attractive light source, with a typical light output power of 20mW for industrial optical module and sensor applications.

◆ APPLICATION

- Sensor
- Industrial Optical Module

◆ FEATURES

- Visible Light Output : $\lambda_p = 850 \text{ nm}$
- Optical Power Output : 20mW CW
- Package Type : TO-18 (5.6mm ϕ)
- Built-in Photo Diode for Monitoring Laser Diode

◆ ELECTRICAL CONNECTION

Bottom View

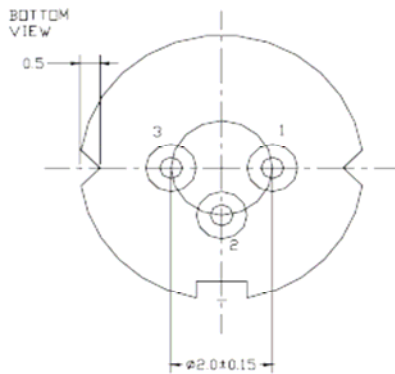

Pin Configuration

A	LD cathode, PD anode (Fig. 1)
B	LD, PD anode (Fig. 2)
C	LD anode, PD cathode (Fig. 3)

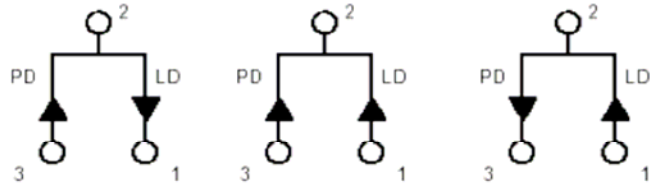

Fig. 1

QL85H6SA

Fig. 2

QL85H6SB

Fig. 3

QL85H6SC



◆ ABSOLUTE MAXIMUM RATING at Tc=25°C

Items	Symbols	Values	Unit
Optical Output Power	P	22	mW
Laser Diode Reverse Voltage	V	2	V
Photo Diode Reverse Voltage	V	30	V
Operating Temperature	Topr	-10 ~ +60	°C
Storage Temperature	Tstg	-40 ~ +85	°C

◆ ELECTRICAL and OPTICAL CHARACTERISTICS at Tc=25°C

Items	Symbols	Min.	Typ.	Max.	Unit	Condition
Optical Output Power	Po	-	20	-	mW	-
Threshold Current	Ith	5	20	35	mA	-
Operating Current	Iop	40	55	70	mA	Po=20mW
Slope Efficiency	SE	0.4	0.5	0.9	mW/mA	10~20 mW
Operating Voltage	Vop	-	2.0	2.5	V	Po=20mW
Lasing Wavelength	λ_p	845	855	865	nm	Po=20mW
Beam Divergence	$\theta_{ }$	7	9	12	deg	Po=20mW
	θ_{\perp}	25	32	40	deg	Po=20mW
Beam Angle	$\Delta\theta_{ }$	-	-	± 2	deg	Po=20mW
	$\Delta\theta_{\perp}$	-	-	± 3	deg	Po=20mW
Monitor Current	I _m	0.1	0.6	1.0	mA	Po=20mW
Astigmatism	As	-	-	15	μm	
Optical Distance	$\Delta X, \Delta Y, \Delta Z$	-	-	± 60	μm	

NOTICE : QL85H6S-A/B/C to be operated on APC

The above product specifications are subject to change without notice.



EXAMPLE of REPRESENTATIVE CHARACTERISTICS

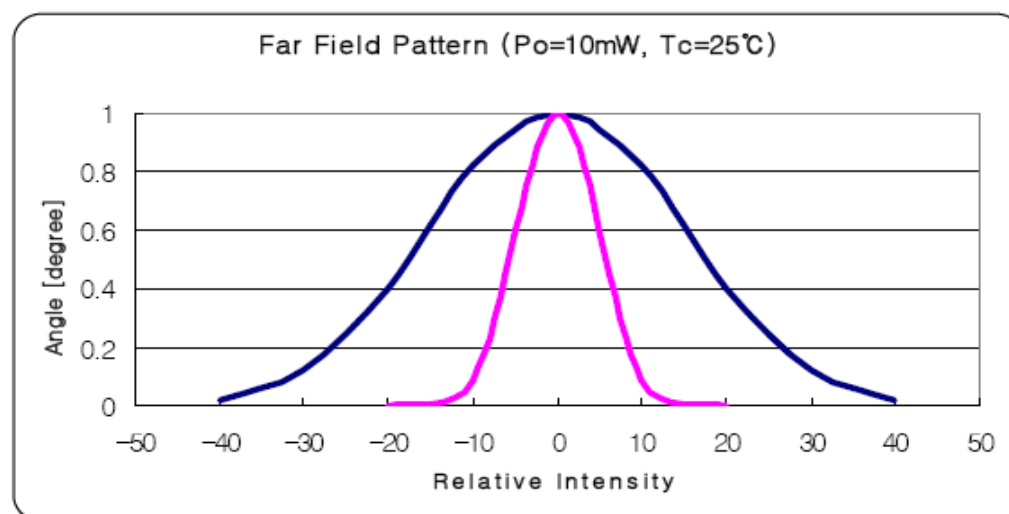
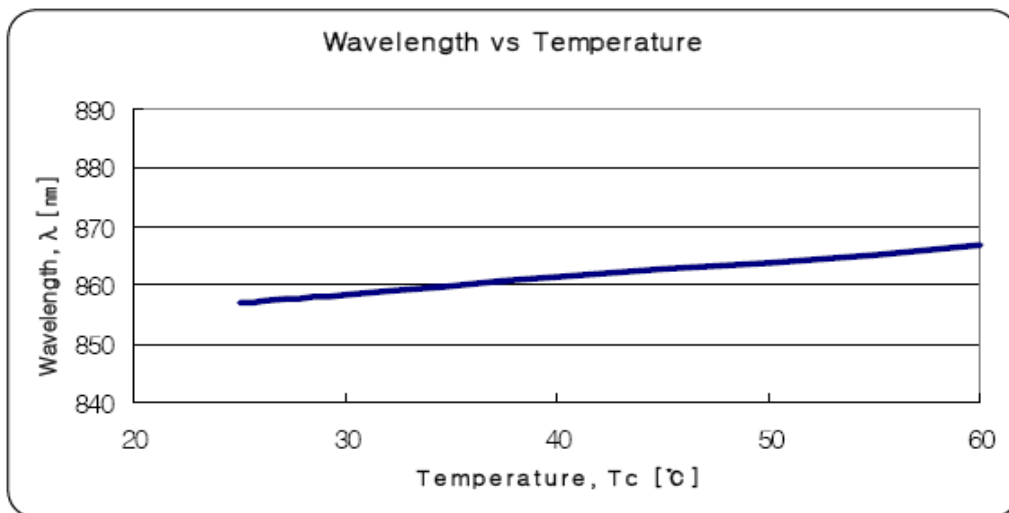
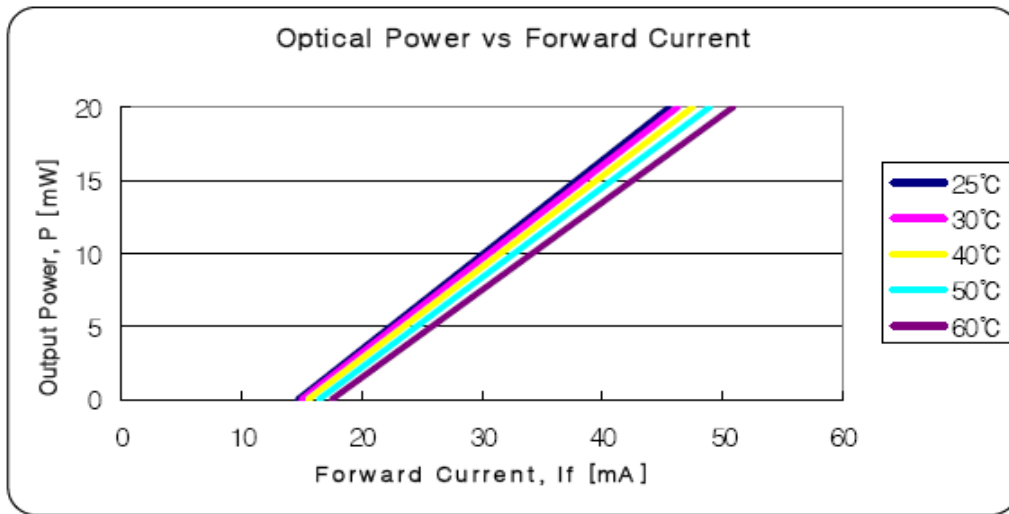

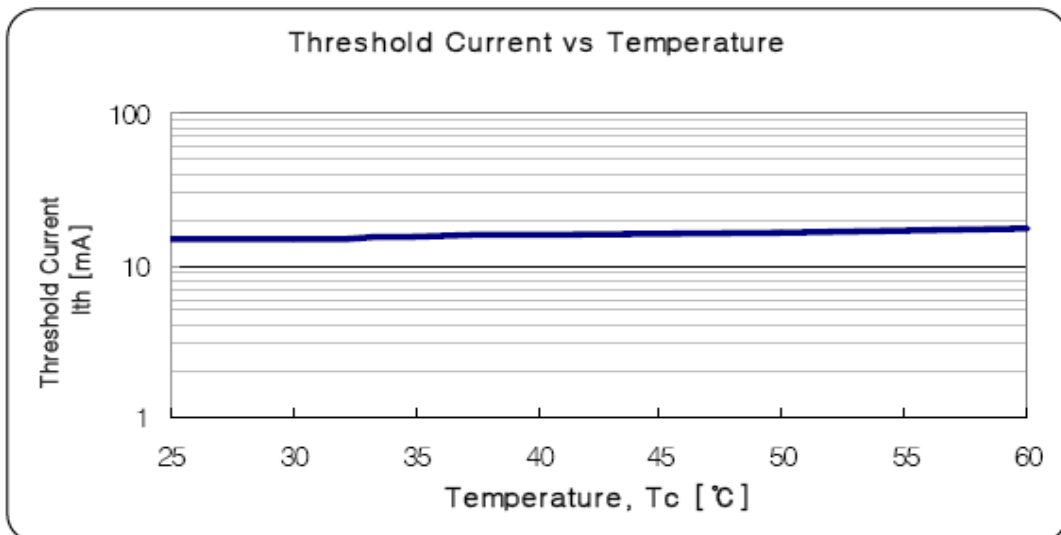
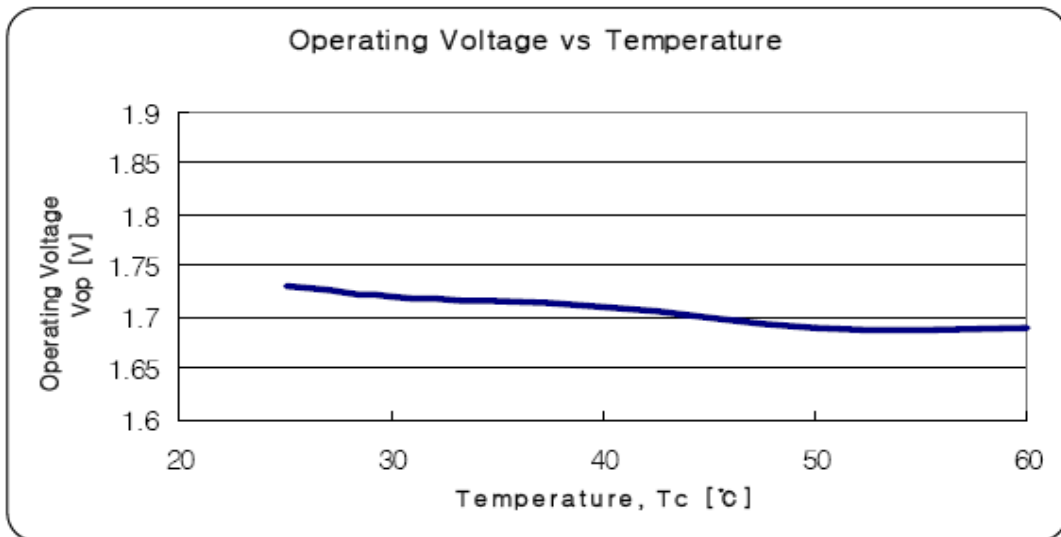
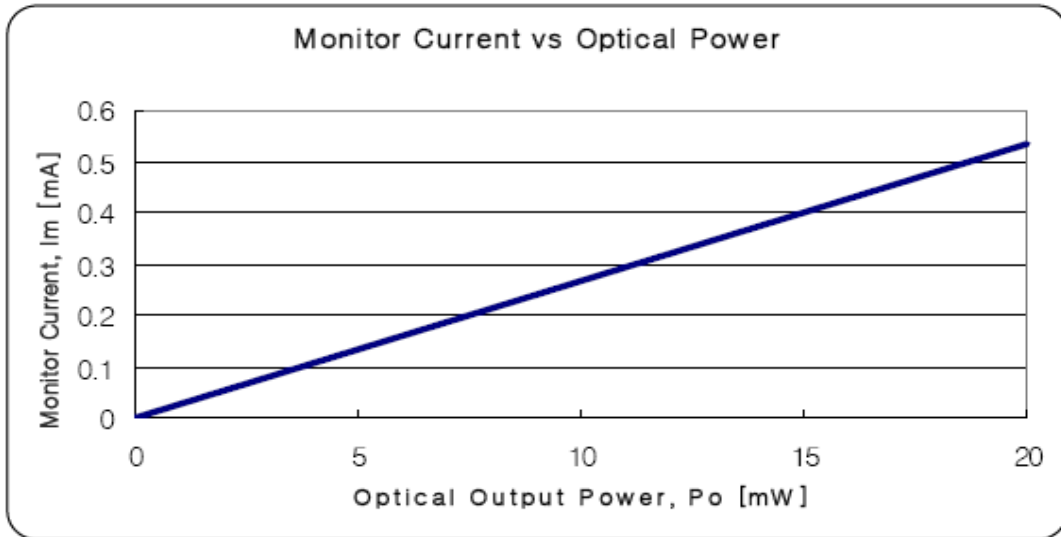



◆ PACKAGE DIMENSION

