



## LM2940

## LINEAR INTEGRATED CIRCUIT

### 1A LOW-DROPOUT POSITIVE VOLTAGE REGULATOR

#### DESCRIPTION

The UTC **LM2940** is a low dropout regulator designed to provide output current up to 1A with a typically 500mV dropout Voltage and a maximum of 1V. It is capable of reducing the ground current when the differential between the input voltage and the output voltage outrun 3V.

UTC **LM2940** offers low quiescent current (typically 30mA at 1A and an input-output differential of 5V). Higher quiescent currents only exist when the regulator is in the dropout mode ( $V_{IN}-V_{OUT} \leq 3V$ ).

#### FEATURES

- \* 500mV Typically Dropout at 1A
- \* Output Current in Excess of 1A
- \* Low Quiescent Current
- \* Reversed-Battery Protection
- \* Current Limit and Thermal Shutdown.
- \* Mirror Image Insertion Protection

#### ORDERING INFORMATION

Ordering Number		Package	Pin Assignment			Packing
Lead Free	Halogen Free		1	2	3	
LM2940Lxx-AA3-R	LM2940G-xx-AA3-R	SOT-223	I	G	O	Tape Reel
LM2940L-xx-TA3-T	LM2940G-xx-TA3-T	TO-220	I	G	O	Tube
LM2940L-xx-TF3-T	LM2940G-xx-TF3-T	TO-220F	I	G	O	Tube
LM2940L-xx-TN3-R	LM2940G-xx-TN3-R	TO-252	I	G	O	Tape Reel
LM2940L-xx-TQ2-R	LM2940G-xx-TQ2-R	TO-263	I	G	O	Tape Reel
LM2940L-xx-TQ2-T	LM2940G-xx-TQ2-T	TO-263	I	G	O	Tube
LM2940L-xx-TQ3-R	LM2940G-xx-TQ3-R	TO-263-3	I	G	O	Tape Reel
LM2940L-xx-TQ3-T	LM2940G-xx-TQ3-T	TO-263-3	I	G	O	Tube

Notes: 1. xx: Output Voltage, refer to Marking Information.

2. Pin Assignment: I:  $V_{IN}$  G: GND O:  $V_{OUT}$

<p>LM2940G-xx-AA3-R</p>	<p>(1) R: Tape Reel, T: Tube  (2) AA3: SOT-223, TA3: TO-220, TF3: TO-220F  TN3: TO-252, TQ2: TO-263, TQ3: TO-263-3  (3) xx: refer to Marking Information  (4) G: Halogen Free and Lead Free, L: Lead Free</p>
-------------------------	---

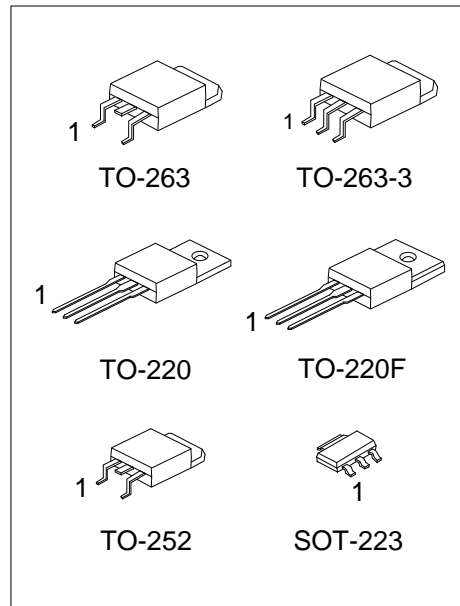

### MARKING INFORMATION

PACKAGE	VOLTAGE CODE	MARKING
SOT-223	50 : 5V 60 : 6V 80 : 8V 90 : 9V 10 : 10V 12 : 12V 15 : 15V	
TO-220 TO-220F TO-252 TO-263 TO-263-3	50 : 5V 60 : 6V 80 : 8V 90 : 9V 10 : 10V 12 : 12V 15 : 15V	

### ■ ABSOLUTE MAXIMUM RATINGS

PARAMETER	SYMBOL	RATINGS	UNIT
Input Voltage	$V_{IN}$	26	V
Power Dissipation	$P_D$	Internally limited	
Junction Temperature	$T_J$	+150	°C
Operating Temperature	$T_{OPR}$	-40 ~ +125	°C
Storage Temperature	$T_{STG}$	-65 ~ +150	°C

Note: Absolute maximum ratings are those values beyond which the device could be permanently damaged. Absolute maximum ratings are stress ratings only and functional device operation is not implied.

### ■ THERMAL DATA

PARAMETER	SYMBOL	RATING	UNIT	
Junction to Ambient	$\theta_{JA}$	SOT-223	174	°C/W
		TO-220/TO-220F	60	
		TO-263/TO-263-3	80	
		TO-252	125	
Junction to Case	$\theta_{JC}$	SOT-223	15	°C/W
		TO-220/TO-263	4	
		TO-263-3	6	
		TO-220F	6	
		TO-252	12	

### ■ ELECTRICAL CHARACTERISTICS

( $T_A=T_J=25^\circ\text{C}$ ,  $V_{IN}=V_{OUT}+5\text{V}$ ,  $I_{OUT}=1\text{A}$  and  $C_{OUT}=22\mu\text{F}$ , unless otherwise specified.)

#### For LM2940-5.0V

PARAMETER	SYMBOL	TEST CONDITIONS	MIN	TYP	MAX	UNIT
Output Voltage	$V_{OUT}$	$6.25\text{V} \leq V_{IN} \leq 26\text{V}$ , $5\text{mA} \leq I_{OUT} \leq 1\text{A}$	4.85	5.00	5.15	V
Line Regulation	$\Delta V_{OUT}$	$V_{OUT}+2\text{V} \leq V_{IN} \leq 26\text{V}$ , $I_{OUT}=5\text{mA}$		20	50	mV
Load Regulation	$\Delta V_{OUT}$	$50\text{mA} \leq I_{OUT} \leq 1\text{A}$		35	50	mV
Output Impedance	$R_{OUT}$	100 mA DC and 20mA <sub>RMS</sub> , $f_o=120\text{Hz}$		35		m $\Omega$
Quiescent Current	$I_Q$	$V_{OUT}+2\text{V} \leq V_{IN} \leq 26\text{V}$ , $I_{OUT}=5\text{mA}$		10	15	mA
Output Noise Voltage	$e_N$	10Hz-100kHz, $I_{OUT}=5\text{mA}$		150		$\mu\text{V}_{RMS}$
Ripple Rejection	RR	$f_o=120\text{Hz}$ , 1V <sub>RMS</sub> , $I_{OUT}=100\text{mA}$	54	72		dB
Long Term Stability				20		mV/1000Hr
Dropout Voltage	$V_D$	$I_{OUT}=1\text{A}$		0.5	0.8	V
		$I_{OUT}=100\text{mA}$		0.13	0.15	
Short Circuit Current	$I_{SC}$	(Note)		2.5		A
Maximum Line Transient	$T_{IN}$	$R_{OUT}=100\Omega$ , $T \leq 100\text{ms}$	60	75		V
Reverse Polarity DC Input Voltage	$V_{RIN}$	$R_{OUT}=100\Omega$	-15	-30		V
Reverse Polarity Transient Input Voltage	$V_{TRRI}$	$R_{OUT}=100\Omega$ , $T \leq 100\text{ms}$	-50	-75		V

## ■ ELECTRICAL CHARACTERISTICS(Cont.)

### For LM2940-6.0V

PARAMETER	SYMBOL	TEST CONDITIONS	MIN	TYP	MAX	UNIT
Output Voltage	$V_{OUT}$	$7.5V \leq V_{IN} \leq 26V, 5mA \leq I_{OUT} \leq 1A$	5.82	6.00	6.18	V
Line Regulation	$\Delta V_{OUT}$	$V_{OUT}+2V \leq V_{IN} \leq 26V, I_{OUT}=5mA$		20	60	mV
Load Regulation	$\Delta V_{OUT}$	$50mA \leq I_{OUT} \leq 1A$		40	60	mV
Output Impedance	$R_{OUT}$	100 mA DC and 20mA <sub>RMS</sub> , $f_o=120Hz$		40		m $\Omega$
Quiescent Current	$I_Q$	$V_{OUT}+2V \leq V_{IN} \leq 26V, I_{OUT}=5mA$		10	15	mA
Output Noise Voltage	$e_N$	10Hz-100kHz, $I_{OUT}=5mA$		180		$\mu V_{RMS}$
Ripple Rejection	RR	$f_o=120Hz, 1V_{RMS}, I_{OUT}=100mA$	60	72		dB
Long Term Stability				20		mV/1000Hr
Dropout Voltage	$V_D$	$I_{OUT}=1A$		0.5	0.8	V
		$I_{OUT}=100mA$		0.13	0.15	
Short Circuit Current	$I_{SC}$	(Note)		2.5		A
Maximum Line Transient	$T_{IN}$	$R_{OUT}=100\Omega, T \leq 100ms$	60	75		V
Reverse Polarity DC Input Voltage	$V_{RIN}$	$R_{OUT}=100\Omega$	-15	-30		V
Reverse Polarity Transient Input Voltage	$V_{TRRI}$	$R_{OUT}=100\Omega, T \leq 100ms$	-50	-75		V

### For LM2940-8.0V

PARAMETER	SYMBOL	TEST CONDITIONS	MIN	TYP	MAX	UNIT
Output Voltage	$V_{OUT}$	$9.4V \leq V_{IN} \leq 26V, 5mA \leq I_{OUT} \leq 1A$	7.76	8.00	8.24	V
Line regulation	$\Delta V_{OUT}$	$V_{OUT}+2V \leq V_{IN} \leq 26V, I_{OUT}=5mA$		20	80	mV
Load Regulation	$\Delta V_{OUT}$	$50mA \leq I_{OUT} \leq 1A$		55	80	mV
Output Impedance	$R_{OUT}$	100 mA DC and 20mA <sub>RMS</sub> , $f_o=120Hz$		55		m $\Omega$
Quiescent Current	$I_Q$	$V_{OUT}+2V \leq V_{IN} \leq 26V, I_{OUT}=5mA$		10	15	mA
Output Noise Voltage	$e_N$	10Hz-100kHz, $I_{OUT}=5mA$		240		$\mu V_{RMS}$
Ripple Rejection	RR	$f_o=120Hz, 1V_{RMS}, I_{OUT}=100mA$	54	66		dB
Long Term Stability				32		mV/1000Hr
Dropout Voltage	$V_D$	$I_{OUT}=1A$		0.5	0.8	V
		$I_{OUT}=100mA$		0.13	0.15	
Short Circuit Current	$I_{SC}$	(Note)		2.5		A
Maximum Line Transient	$T_{IN}$	$R_{OUT}=100\Omega, T \leq 100ms$	60	75		V
Reverse Polarity DC Input Voltage	$V_{RIN}$	$R_{OUT}=100\Omega$	-15	-30		V
Reverse Polarity Transient Input Voltage	$V_{TRRI}$	$R_{OUT}=100\Omega, T \leq 100ms$	-50	-75		V

### For LM2940-9.0V

PARAMETER	SYMBOL	TEST CONDITIONS	MIN	TYP	MAX	UNIT
Output Voltage	$V_{OUT}$	$10.5V \leq V_{IN} \leq 26V, 5mA \leq I_{OUT} \leq 1A$	8.73	9.00	9.27	V
Line regulation	$\Delta V_{OUT}$	$V_{OUT}+2V \leq V_{IN} \leq 26V, I_{OUT}=5mA$		20	90	mV
Load Regulation	$\Delta V_{OUT}$	$50mA \leq I_{OUT} \leq 1A$		60	90	mV
Output Impedance	$R_{OUT}$	100 mA DC and 20mA <sub>RMS</sub> , $f_o=120Hz$		60		m $\Omega$
Quiescent Current	$I_Q$	$V_{OUT}+2V \leq V_{IN} \leq 26V, I_{OUT}=5mA$		10	15	mA
Output Noise Voltage	$e_N$	10Hz-100kHz, $I_{OUT}=5mA$		270		$\mu V_{RMS}$
Ripple Rejection	RR	$f_o=120Hz, 1V_{RMS}, I_{OUT}=100mA$	52	64		dB
Long Term Stability				34		mV/1000Hr
Dropout Voltage	$V_D$	$I_{OUT}=1A$		0.5	0.8	V
		$I_{OUT}=100mA$		0.13	0.15	
Short Circuit Current	$I_{SC}$	(Note)		2.5		A
Maximum Line Transient	$T_{IN}$	$R_{OUT}=100\Omega, T \leq 100ms$	60	75		V
Reverse Polarity DC Input Voltage	$V_{RIN}$	$R_{OUT}=100\Omega$	-15	-30		V
Reverse Polarity Transient Input Voltage	$V_{TRRI}$	$R_{OUT}=100\Omega, T \leq 100ms$	-50	-75		V

## ■ ELECTRICAL CHARACTERISTICS(Cont.)

For LM2940-10V

PARAMETER	SYMBOL	TEST CONDITIONS	MIN	TYP	MAX	UNIT
Output Voltage	$V_{OUT}$	$11.5V \leq V_{IN} \leq 26V, 5mA \leq I_{OUT} \leq 1A$	9.70	10.00	10.30	V
Line regulation	$\Delta V_{OUT}$	$V_{OUT} + 2V \leq V_{IN} \leq 26V, I_{OUT} = 5mA$		20	100	mV
Load Regulation	$\Delta V_{OUT}$	$50mA \leq I_{OUT} \leq 1A$		65	100	mV
Output Impedance	$R_{OUT}$	100mA DC and 20mA <sub>RMS</sub> , $f_0=120Hz$		65		m $\Omega$
Quiescent Current	$I_Q$	$V_{OUT} + 2V \leq V_{IN} \leq 26V, I_{OUT} = 5mA$		10	15	mA
Output Noise Voltage	$e_N$	10Hz-100kHz, $I_{OUT} = 5mA$		300		$\mu V_{RMS}$
Ripple Rejection	RR	$f_0=120Hz, 1V_{RMS}, I_{OUT} = 100mA$	51	63		dB
Long Term Stability				36		mV/1000Hr
Dropout Voltage	$V_D$	$I_{OUT} = 1A$		0.5	0.8	V
		$I_{OUT} = 100mA$		0.13	0.15	
Short Circuit Current	$I_{SC}$	(Note)		2.5		A
Maximum Line Transient	$T_{IN}$	$R_{OUT}=100\Omega, T \leq 100ms$	60	75		V
Reverse Polarity DC Input Voltage	$V_{RIN}$	$R_{OUT}=100\Omega$	-15	-30		V
Reverse Polarity Transient Input Voltage	$V_{TRRI}$	$R_{OUT}=100\Omega, T \leq 100ms$	-50	-75		V

UTC LM2940-12V

PARAMETER	SYMBOL	TEST CONDITIONS	MIN	TYP	MAX	UNIT
Output Voltage	$V_{OUT}$	$13.6V \leq V_{IN} \leq 26V, 5mA \leq I_{OUT} \leq 1A$	11.64	12.00	12.36	V
Line regulation	$\Delta V_{OUT}$	$V_{OUT} + 2V \leq V_{IN} \leq 26V, I_{OUT} = 5mA$		20	120	mV
Load Regulation	$\Delta V_{OUT}$	$50mA \leq I_{OUT} \leq 1A$		55	120	mV
Output Impedance	$R_{OUT}$	100mA DC and 20mA <sub>RMS</sub> , $f_0=120Hz$		80		m $\Omega$
Quiescent Current	$I_Q$	$V_{OUT} + 2V \leq V_{IN} \leq 26V, I_{OUT} = 5mA$		10	15	mA
Output Noise Voltage	$e_N$	10Hz-100kHz, $I_{OUT} = 5mA$		360		$\mu V_{RMS}$
Ripple Rejection	RR	$f_0=120Hz, 1V_{RMS}, I_{OUT} = 100mA$	54	66		dB
Long Term Stability				48		mV/1000Hr
Dropout Voltage	$V_D$	$I_{OUT} = 1A$		0.5	0.8	V
		$I_{OUT} = 100mA$		0.11	0.15	
Short Circuit Current	$I_{SC}$	(Note)		2.5		A
Maximum Line Transient	$T_{IN}$	$R_{OUT}=100\Omega, T \leq 100ms$	60	75		V
Reverse Polarity DC Input Voltage	$V_{RIN}$	$R_{OUT}=100\Omega$	-15	-30		V
Reverse Polarity Transient Input Voltage	$V_{TRRI}$	$R_{OUT}=100\Omega, T \leq 100ms$	-50	-75		V

### ■ ELECTRICAL CHARACTERISTICS(Cont.)

#### UTC LM2940-15V

PARAMETER	SYMBOL	TEST CONDITIONS	MIN	TYP	MAX	UNIT
Output Voltage	$V_{OUT}$	$16.75V \leq V_{IN} \leq 26V, 5mA \leq I_{OUT} \leq 1A$	14.55	15.00	15.45	V
Line regulation	$\Delta V_{OUT}$	$V_{OUT} + 2V \leq V_{IN} \leq 26V, I_{OUT} = 5mA$		20	150	mV
Load Regulation	$\Delta V_{OUT}$	$50mA \leq I_{OUT} \leq 1A$		70	150	mV
Output Impedance	$R_{OUT}$	100mA DC and 20mA <sub>RMS</sub> , $f_o=120Hz$		100		m $\Omega$
Quiescent Current	$I_Q$	$V_{OUT} + 2V \leq V_{IN} \leq 26V, I_{OUT} = 5mA$		10	15	mA
Output Noise Voltage	$e_N$	10Hz-100kHz, $I_{OUT} = 5mA$		450		$\mu V_{RMS}$
Ripple Rejection	RR	$f_o=120Hz, 1V_{RMS}, I_{OUT} = 100mA$	52	64		dB
Long Term Stability				60		mV/1000Hr
Dropout Voltage	$V_D$	$I_{OUT} = 1A$		0.5	0.8	V
		$I_{OUT} = 100mA$		0.11	0.15	
Short Circuit Current	$I_{SC}$	(Note)		2.5		A
Maximum Line Transient	$T_{IN}$	$R_{OUT}=100\Omega, T \leq 100ms$	60	75		V
Reverse Polarity DC Input Voltage	$V_{RIN}$	$R_{OUT}=100\Omega$	-15	-30		V
Reverse Polarity Transient Input Voltage	$V_{TRRI}$	$R_{OUT}=100\Omega, T \leq 100ms$	-50	-75		V

Note: Output current will decrease with temperature increase but will not drop below 1A at the maximum specified temperature.

## ■ TYPICAL APPLICATION

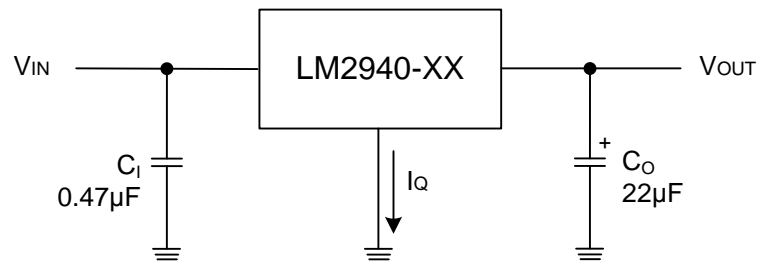

Note: 1. C<sub>1</sub> is required if regulator is located far from power supply filter.

2. C<sub>0</sub> must be higher than 22µF for stability, and locate as close as possible to the regulator.

## TYPICAL CHARACTERISTICS

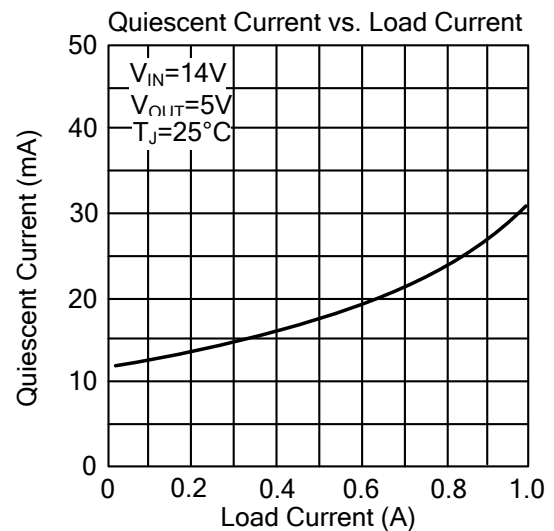
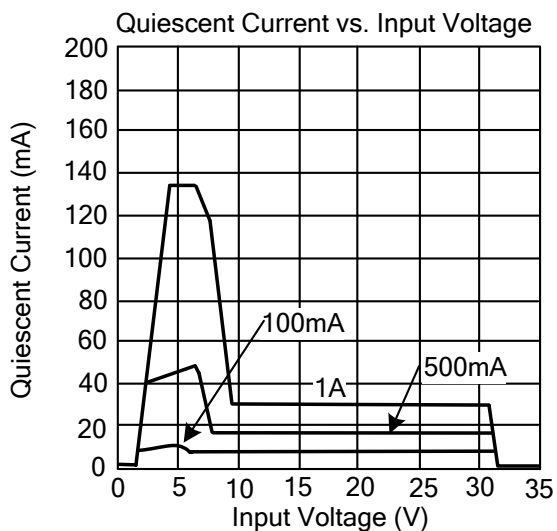
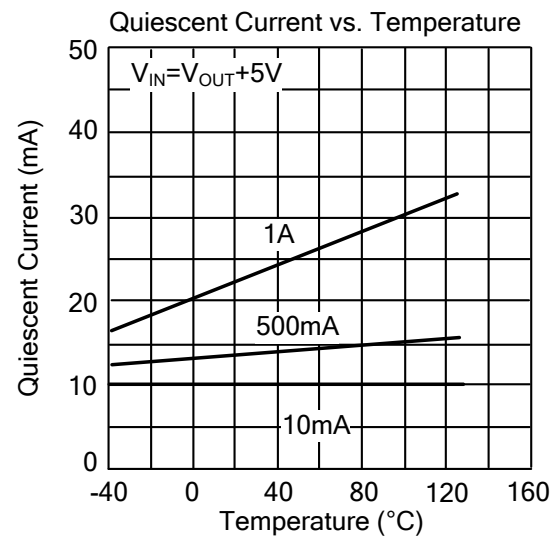
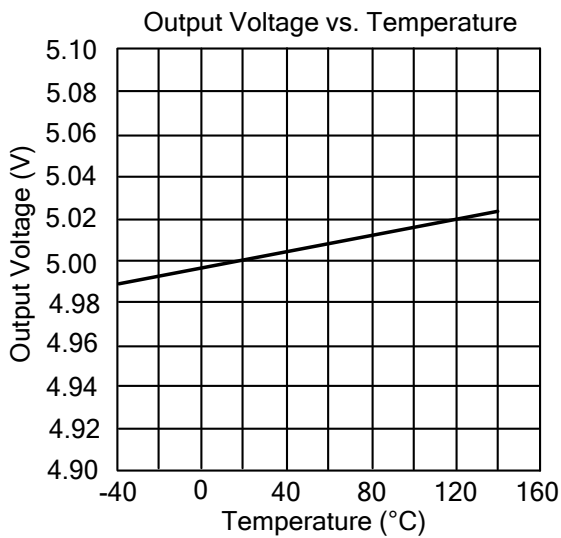
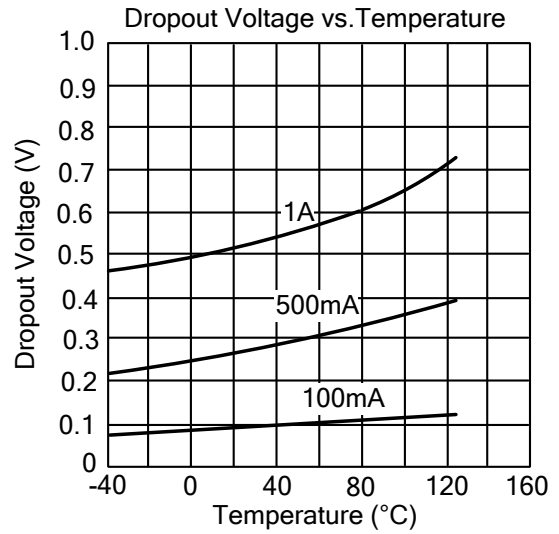
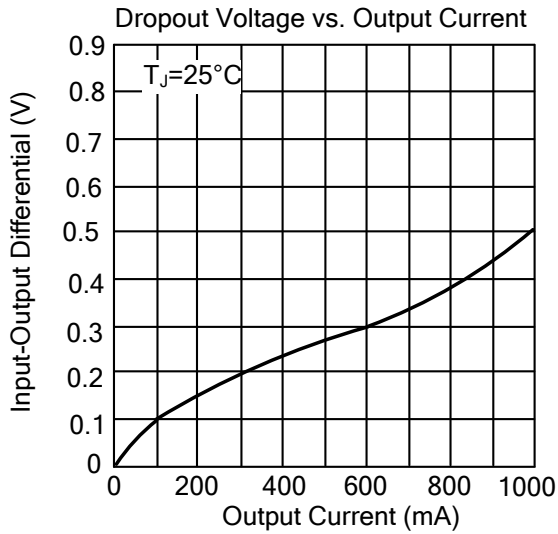



## ■ TYPICAL CHARACTERISTICS (Cont.)

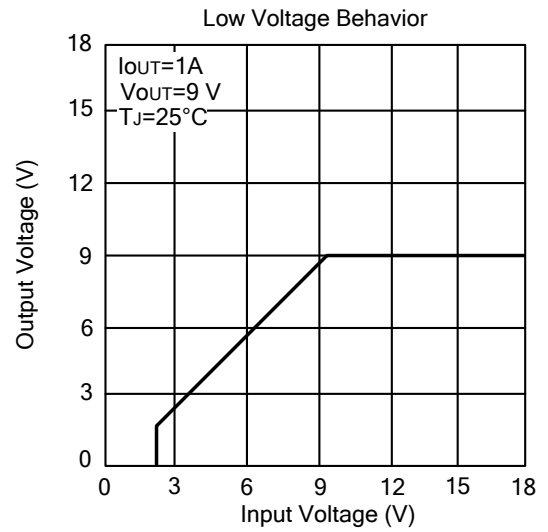
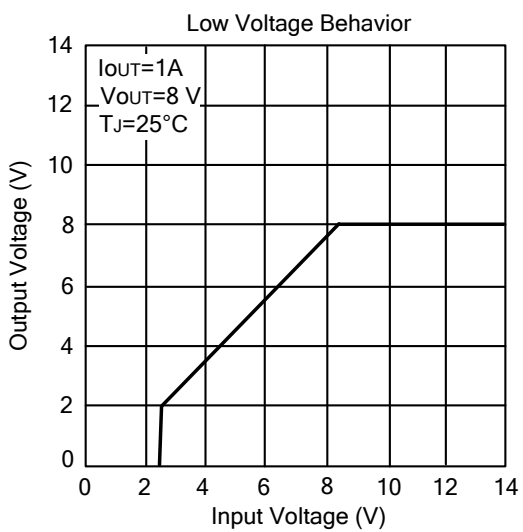
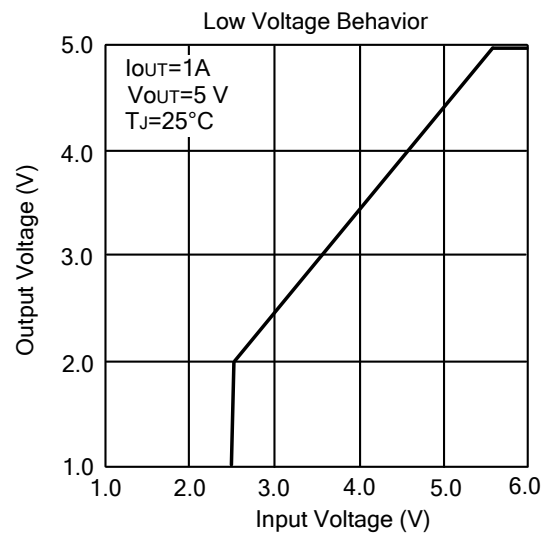
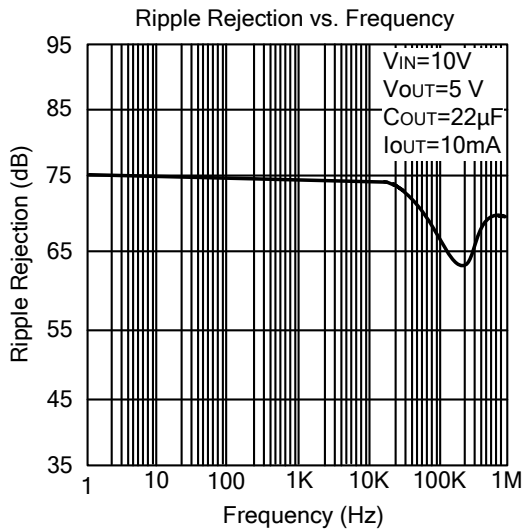
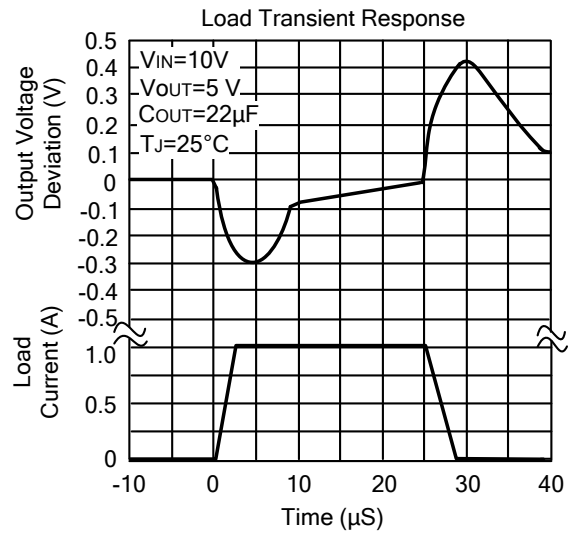
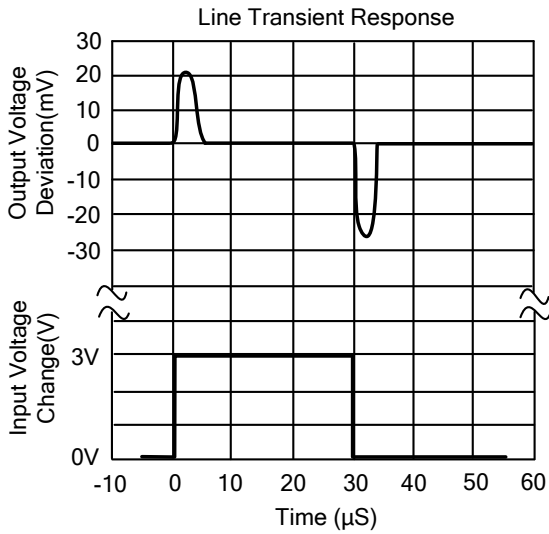

## ■ TYPICAL CHARACTERISTICS (Cont.)

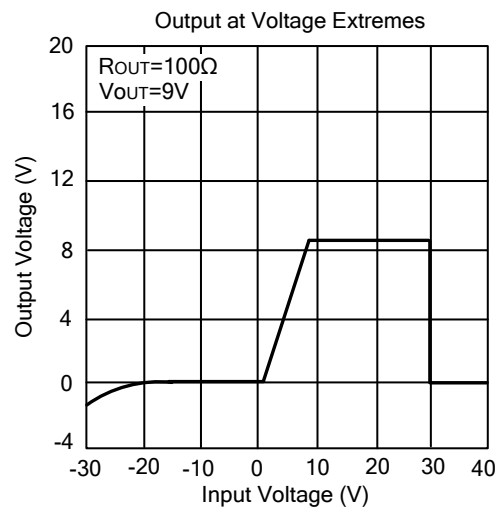
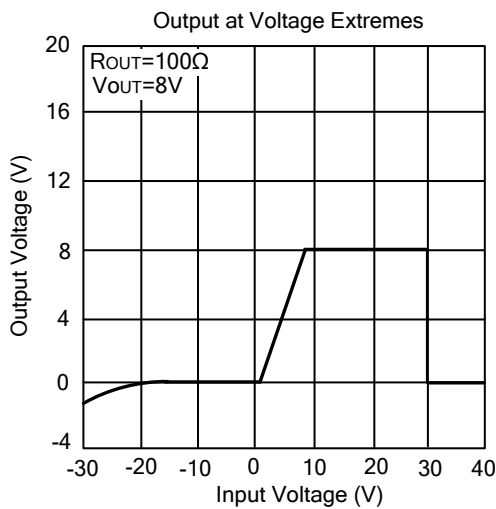
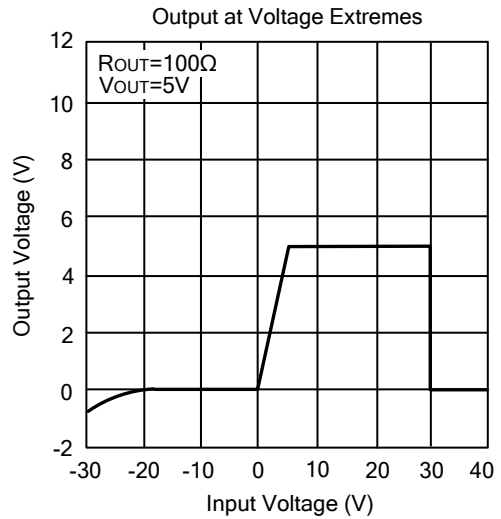
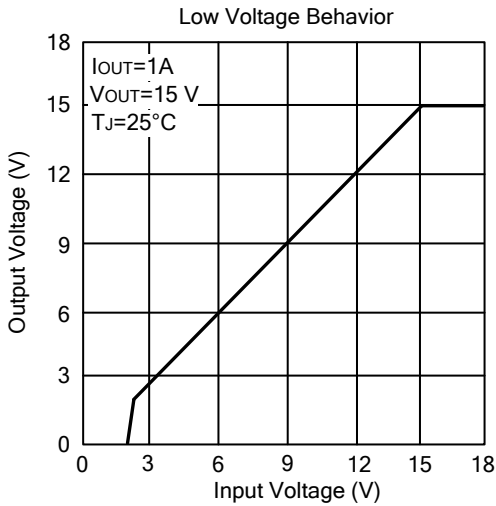
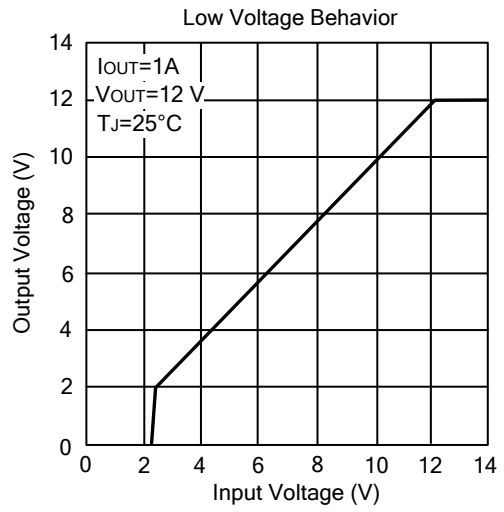
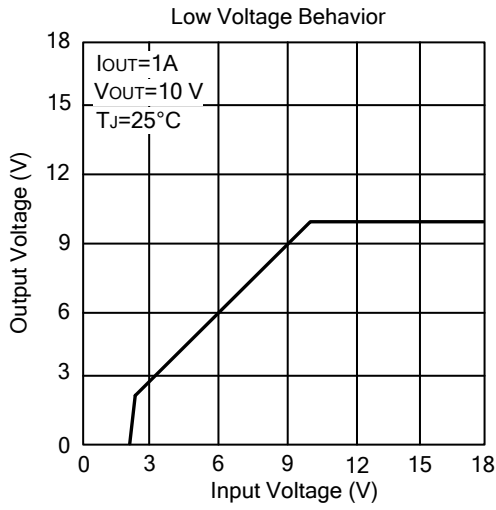

## ■ TYPICAL CHARACTERISTICS (Cont.)

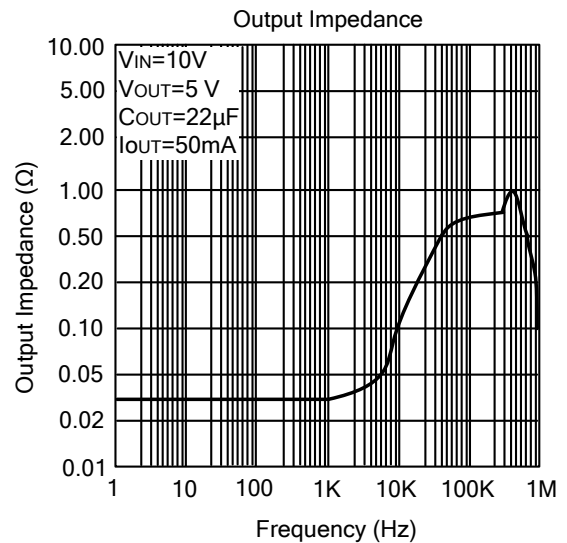
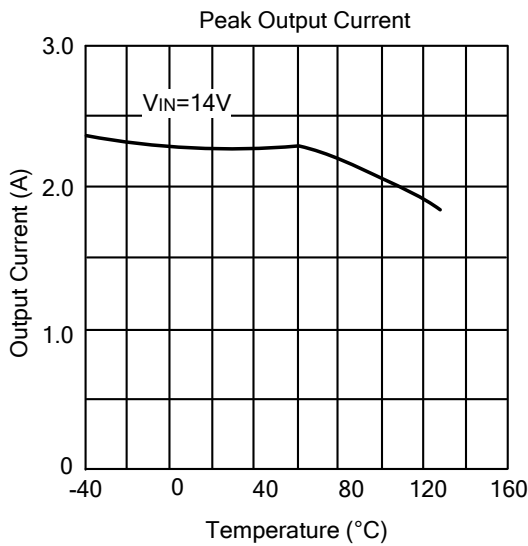
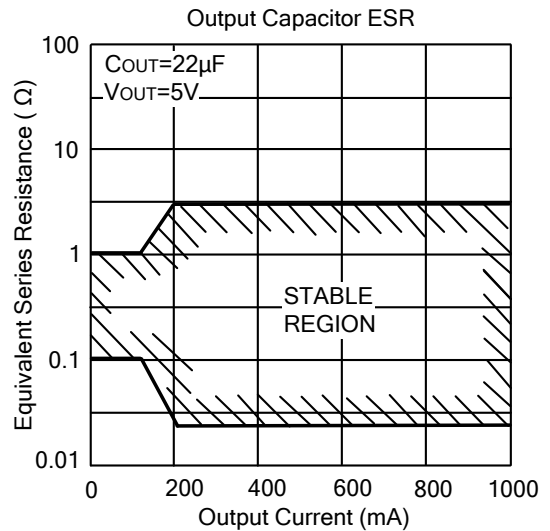
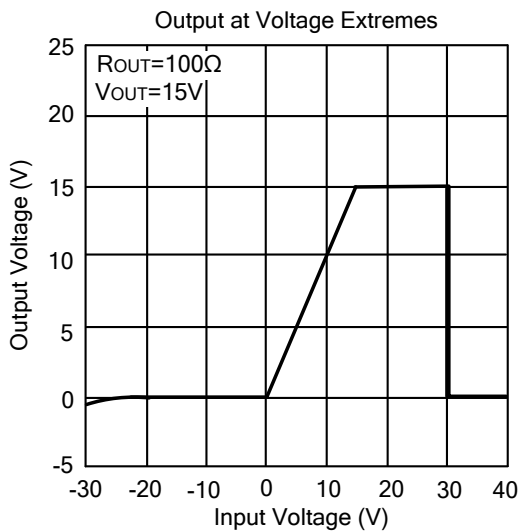
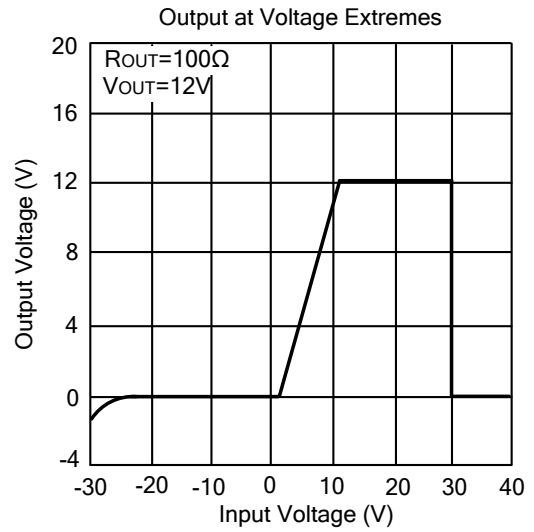
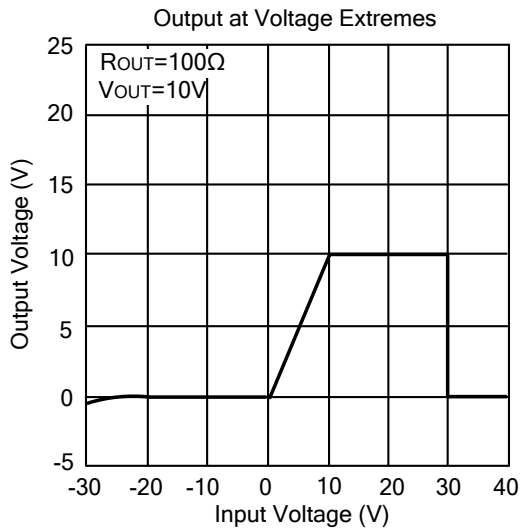

## ■ TYPICAL CHARACTERISTICS (Cont.)

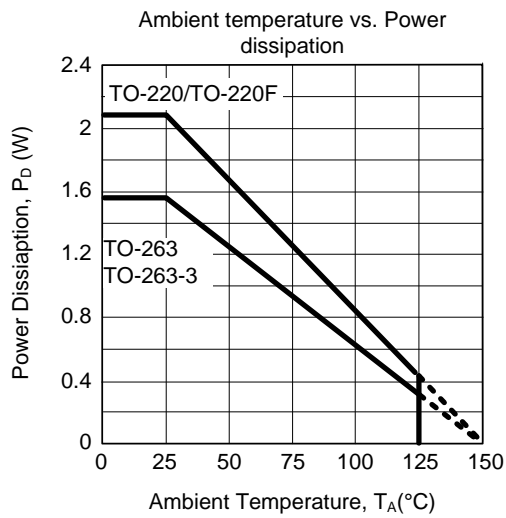

UTC assumes no responsibility for equipment failures that result from using products at values that exceed, even momentarily, rated values (such as maximum ratings, operating condition ranges, or other parameters) listed in products specifications of any and all UTC products described or contained herein. UTC products are not designed for use in life support appliances, devices or systems where malfunction of these products can be reasonably expected to result in personal injury. Reproduction in whole or in part is prohibited without the prior written consent of the copyright owner. UTC reserves the right to make changes to information published in this document, including without limitation specifications and product descriptions, at any time and without notice. This document supersedes and replaces all information supplied prior to the publication hereof.