



ON Semiconductor®

<http://onsemi.com>

LA4815VH

Monolithic Linear IC

Monaural Power Amplifier

Overview

The LA4815VH incorporates a 1-channel power amplifier with a wide operating supply voltage range built into a surface-mounted package. This IC also has a mute function and requires only a few external components, making it suitable for low-cost set design.

Applications

Intercoms, door phones, transceivers, radios, toys, home appliances with voice guidance, etc.

Features

- Built-in 1-channel power amplifier
 - Output power 1 = 1.84W typ. ($V_{CC} = 12V$, $R_L = 8\Omega$, THD = 10%)
 - Output power 2 = 1.55W typ. ($V_{CC} = 9V$, $R_L = 4\Omega$, THD = 10%)
 - Output power 3 = 0.36W typ. ($V_{CC} = 6V$, $R_L = 8\Omega$, THD = 10%)
 - Output power 4 = 0.23W typ. ($V_{CC} = 5V$, $R_L = 8\Omega$, THD = 10%)
- Mute function
- Selectable voltage gain : 2 types
26dB/40dB
 - * Gain values between 26 and 40dB can also be set by adding external components (two resistors).
- Only a few external components
4 components/total
- Wide supply voltage range
4 to 16V

LA4815VH

Specifications

Maximum Ratings at $T_a = 25^\circ\text{C}$

Parameter	Symbol	Conditions	Ratings	Unit
Maximum power supply voltage	V_{CC} max		18	V
Allowable power dissipation	P_d max	* Mounted on the board	1.5	W
Operating temperature	T_{opr}		-30 to +75	$^\circ\text{C}$
Storage temperature	T_{stg}		-40 to +150	$^\circ\text{C}$

* Mounted on Our evaluation board : Double-sided board with dimensions of 50mm \times 50mm \times 1.6mm (glass epoxy)

Stresses exceeding Maximum Ratings may damage the device. Maximum Ratings are stress ratings only. Functional operation above the Recommended Operating Conditions is not implied. Extended exposure to stresses above the Recommended Operating Conditions may affect device reliability.

Operating Conditions at $T_a = 25^\circ\text{C}$

Parameter	Symbol	Conditions	Ratings	Unit
Recommended power supply voltage	V_{CC}		12	V
Recommended load resistance	R_L		4 to 32	Ω
Allowable operating supply voltage range	V_{CC} op		4 to 16	V

* The supply voltage level to be used must be determined with due consideration given to the allowable power dissipation of the IC.

Electrical Characteristics at $T_a = 25^\circ\text{C}$, $V_{CC} = 12\text{V}$, $R_L = 8\Omega$, $f_{in} = 1\text{kHz}$

Parameter	Symbol	Conditions	Ratings			Unit
			min	typ	max	
Quiescent current drain-1	I_{CCOP1}	No signal		5.3	9.5	mA
Quiescent current drain-2	I_{CCOP2}	No signal, pin 3 = LOW		2.4		mA
Maximum output power-1	POMAX1	THD = 10%	1.2	1.84		W
Maximum output power-2	POMAX2	THD = 10%, $V_{CC} = 9\text{V}$, $R_L = 4\Omega$		1.55		W
Voltage gain-1	VG1	$V_{IN} = -30\text{dBV}$	23.9	25.9	27.9	dB
Voltage gain-2	VG2	$V_{IN} = -40\text{dBV}$, pin 4/pin11 = GND	37	39.5	42	dB
Total harmonic distortion	THD	$V_{IN} = -30\text{dBV}$		0.125	0.7	%
Mute attenuation	MT	$V_{IN} = -10\text{dBV}$, pin 3 = LOW	-90	-115		dBV
Output noise voltage	V_{NOUT}	$R_g = 620\Omega$, 20 to 20kHz		40	100	μV_{rms}
Ripple rejection ratio	SVRR	$R_g = 620\Omega$, $f_r = 100\text{Hz}$, $V_r = -20\text{dBV}$		44		dB
Mute control voltage-LOW	V3cntL	Mute mode			0.3	V
Mute control voltage-HIGH1	V3cntH1	Mute released, $V_{CC} = 6.5\text{V}$ or lower	1.8			V
Mute control voltage-HIGH2	V3cntH2	Mute released, $V_{CC} = 6.5\text{V}$ or higher	2.4			V
Input resistance	R_i			100		k Ω

Package Dimensions

unit : mm (typ)
3313

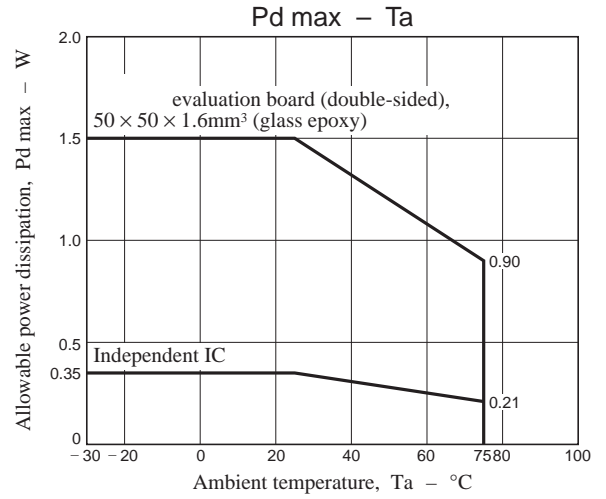
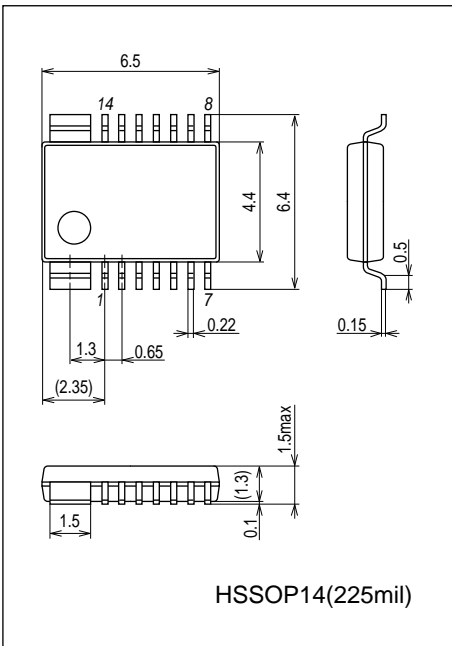

Evaluation board

- Double-sided circuit board
Dimensions : 50mm × 50mm × 1.6mm
Top Layer (Top view)

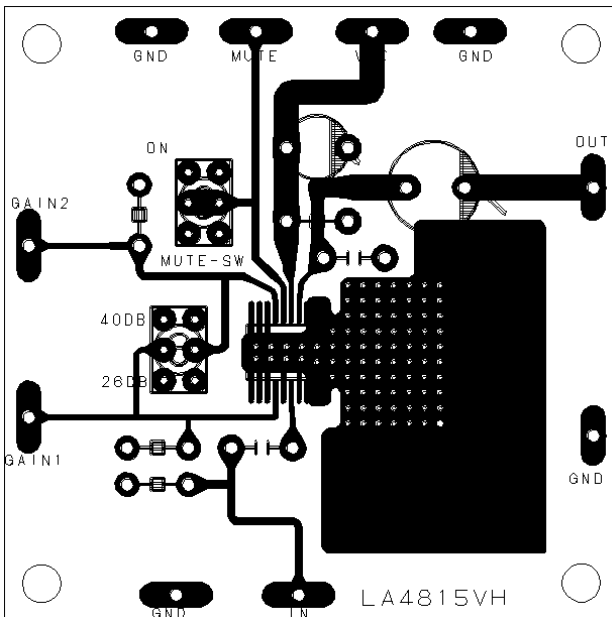

Bottom Layer (Top view)

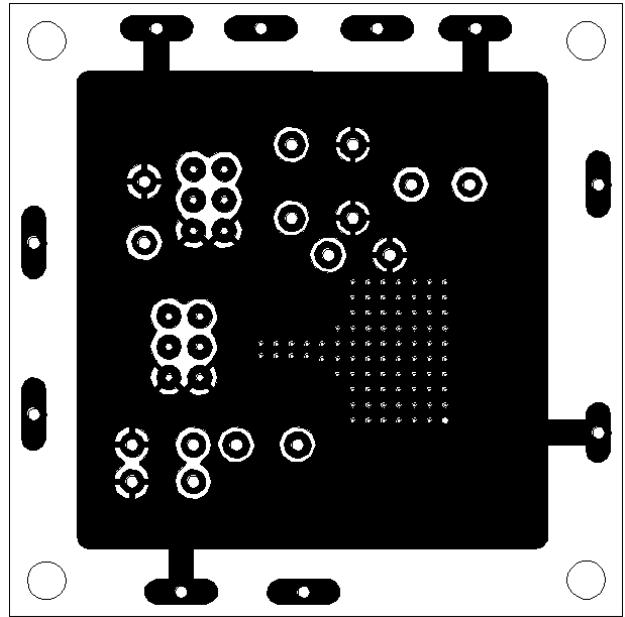

LA4815VH

Block Diagram and Sample Application Circuit

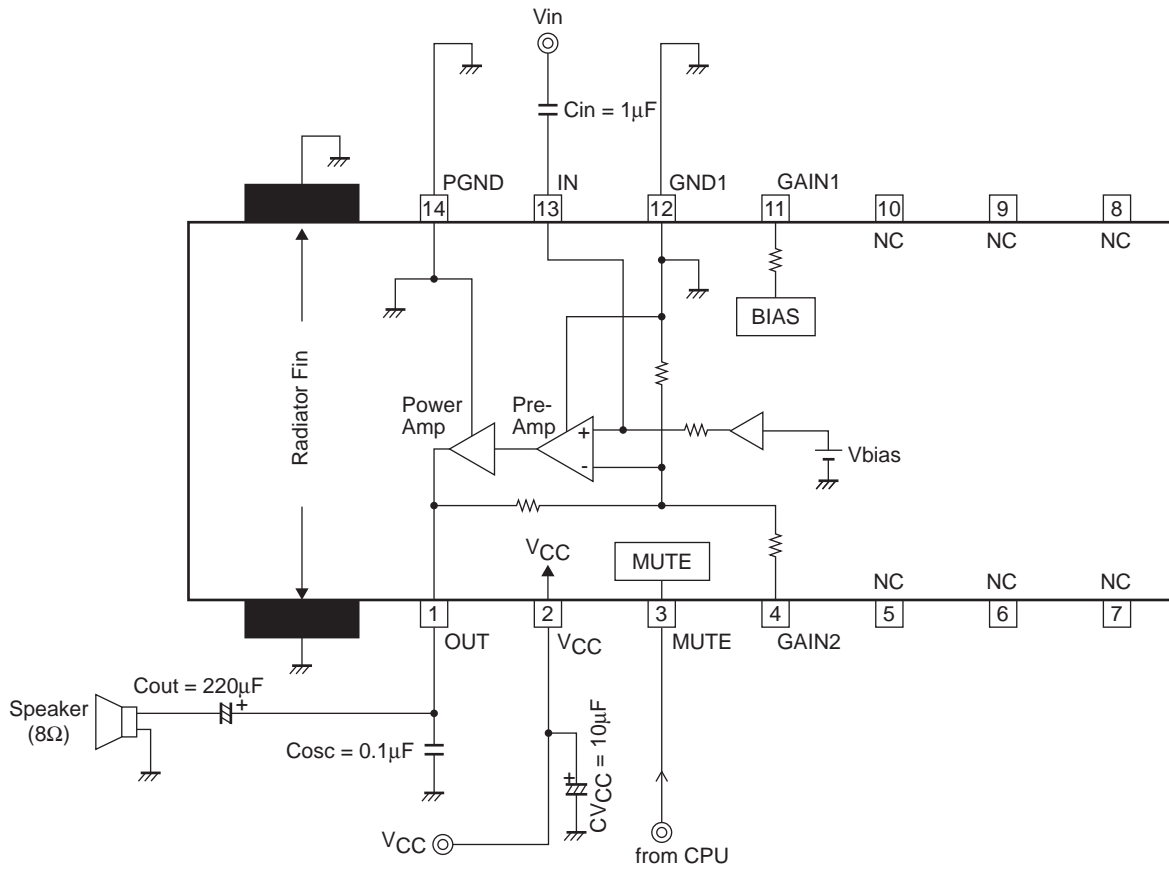

Test Circuit

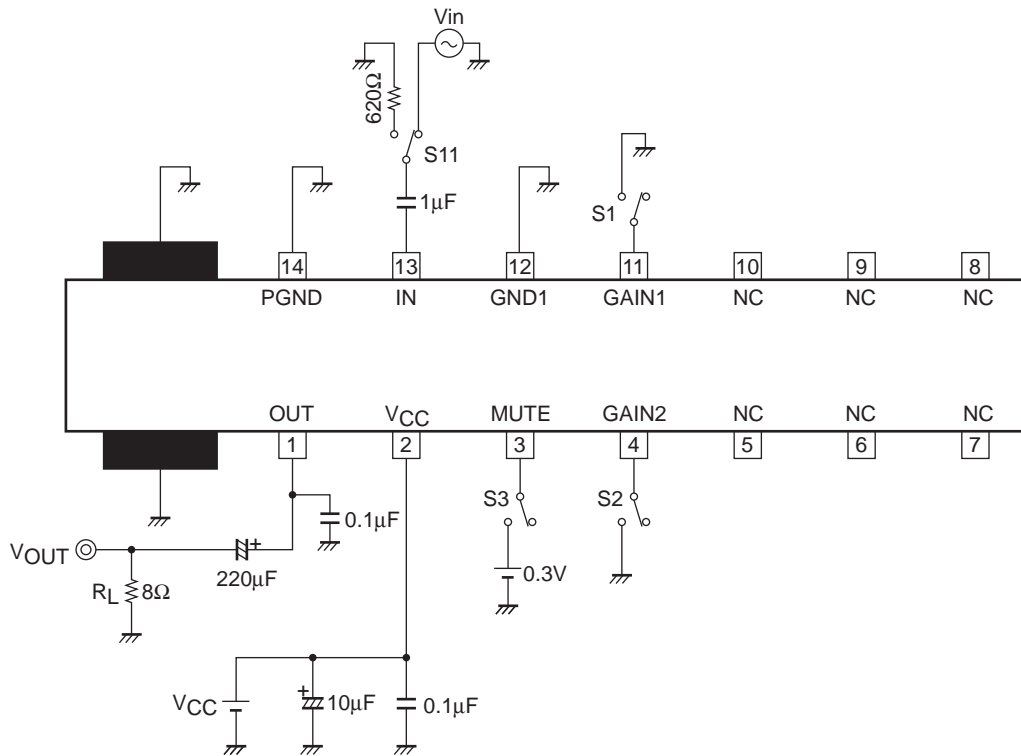

LA4815VH

Pin Functions

Pin No.	Pin Name	Pin Voltage	Description	Equivalent Circuit
		$V_{CC} = 12V$		
11	GAIN1	0.35	Gain switching pin. <ul style="list-style-type: none"> • 26dB mode when left open. • 40dB mode when connected to ground. (Both pins 11 and 4 must be reconfigured at the same time.)	
12	GND1	0	Preamplifier system ground pin.	
13	IN	1.7	Input pin.	
14	PGND	0	Power amplifier ground pin.	
1	OUT	5.9	Power amplifier output pin.	
2	V_{CC}	12	Power supply pin.	
3	MUTE	4.9	Mute control pin. <ul style="list-style-type: none"> • Mute ON \Rightarrow Low • Mute OFF \Rightarrow High 	
4	GAIN2	0.35	Gain switching pin. <ul style="list-style-type: none"> • 26dB mode when left open. • 40dB mode when connected to ground. (Both pins 11 and 4 must be reconfigured at the same time.)	

Notes on Using the IC

1. Voltage gain settings (Pins 4 and 11)

The voltage gain of the power amplifier is fixed by the internal resistors.

- Pins 4 and 11 be left open : Approximately 26dB
- Pins 4 and 11 connected to GND : Approximately 39.5dB

Note that the voltage gain can be changed using two resistors. (See Fig. 1)

- Voltage gain setting : According to the resistor connected between Pin 4 and Pin 12 (GND1)
 - * Voltage gain = $20\log(20 \times (625 + R_{vg1}) / (125 + R_{vg1}))$
- Output DC voltage setting : According to the resistor connected between Pin 11 and Pin 12 (GND1)
 - * $R_{vg1} = R_{vg2}$ must be satisfied.

In addition, the voltage gain can also be lowered to approximately 20dB (when using 5V or 6V power supply) by an application such as shown in Fig. 2 below.

- Voltage gain setting : According to the resistor connected between Pin 4 and Pin 1 (OUT)
 - * Voltage gain = $20\log(20 \times (125 + R_{vg3}) / (10,125 + R_{vg3}))$
- Output DC voltage setting : According to the resistor connected between Pin 11 and Pin 2 (V_{CC})
 - * Set the resistor values so that the Pin 5 (OUT) DC voltage is approximately half the supply voltage.

Example : When $R_{vg3} = 10k\Omega$, $R_{vg4} = 22k\Omega$ (when $V_{CC} = 6V$)

However, note that using this method to greatly lower the voltage gain deteriorates the characteristics, so the voltage gain should be lowered only to approximately 20dB. In addition, when using a high supply voltage (7V or more), the clipped waveform may invert, so this voltage gain reduction method must not be used in these cases.

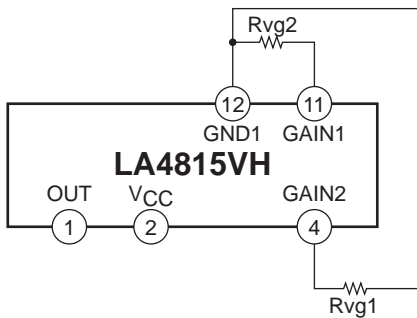

Figure 1

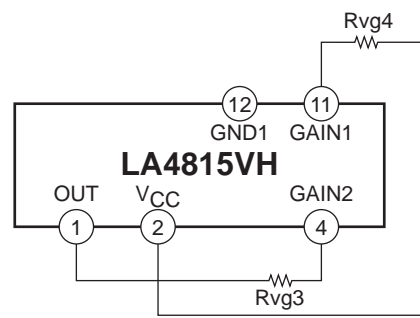

Figure 2

2. Signal source impedance : rg

As mentioned above, since the input coupling capacitor C_{in} affects the ripple rejection ratio, the signal source impedance value r_g , which is associated with this capacitor, also affects the ripple rejection ratio, so r_g should be as small as possible. Therefore, when attenuating the signal at the C_{in} front end as shown in Fig. 4, the constants should be set in consideration of these characteristics. Using the smallest resistor R_{g1} value possible is recommended.

In addition, when setting the signal level, the voltage gain should be set on the LA4815VH side and the input front-end should be configured using only the input coupling capacitor, C_{in} , as shown in Fig. 5 in order to maximize the ripple rejection ratio.

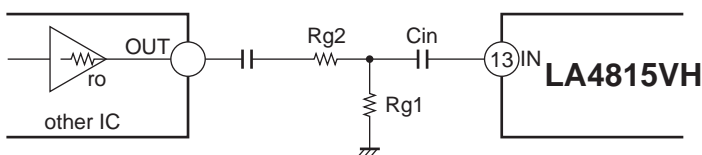

Figure 4

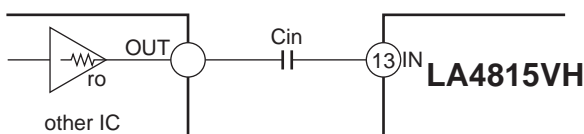

Figure 5

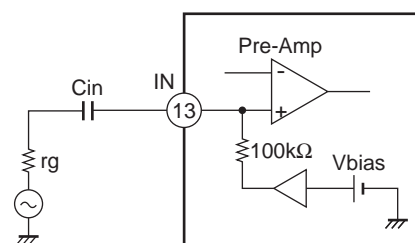

Figure 3

LA4815VH

3. Mute control pin (Pin 3)

The internal power amplifier circuit can be disabled and audio mute is turned on by controlling the voltage applied to Pin 3. Control can be performed directly using the CPU output port, but digital noise from the CPU may worsen the LA4815VH noise floor. Therefore, inserting a series resistor, R_{m1} (1 to 2.2k Ω) as shown in Fig. 6, is recommended.

- Mute ON : Low
- Mute OFF : High or open

In addition, the Pin 3 DC voltage is dependent on the supply voltage, so a reverse current flows to the CPU power supply line when the Pin 3 voltage is higher than the CPU supply voltage. In these cases, connect a resistor, R_{m2} (see Fig. 7) between Pin 3 and GND to lower the Pin 3 DC voltage as shown in Fig. 6.

Note that when not using the mute function, Pin 3 must be left open.

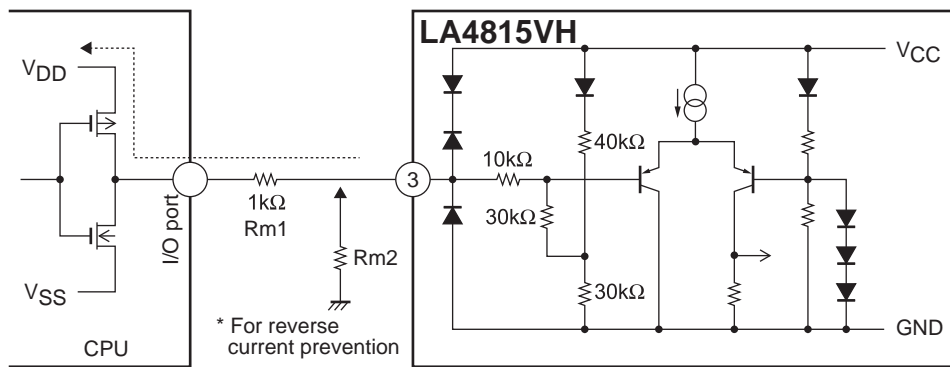

Figure 6

Reverse current prevention resistor value : R_{m2} (reference value) ← When V_3 is set to approximately 2.5V

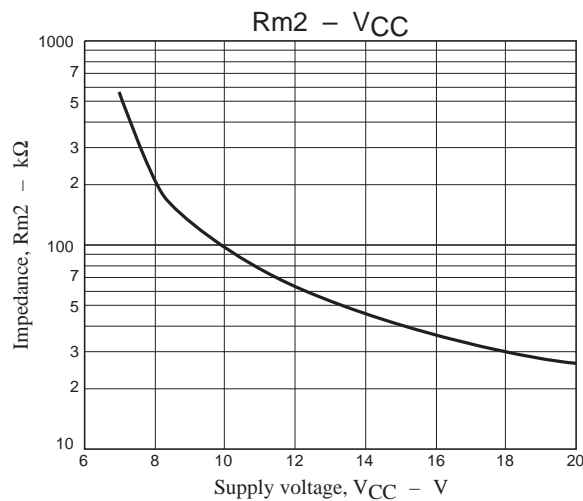

Figure 7

4. Mute control timing

When performing mute control, exercise control at the timing shown in Fig. 8.

During power-on : $T_{wu} = 0$ to 50ms

* Pins 2 and 3 can also rise simultaneously.

During power-off : $T_{wd} = 100$ to 200ms

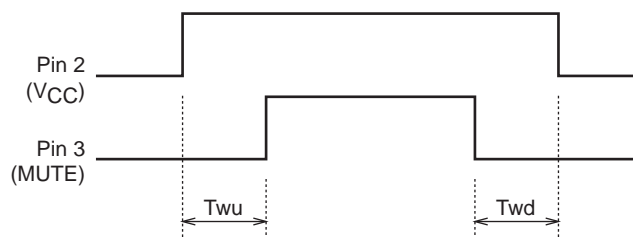

Figure 8

5. Popping noise reduction during power-off

The power supply line can be directly controlled ON and OFF without using the mute function. However, when using a high supply voltage, the shock noise and aftersound during power-off tends to worsen. One method of coping with this is to connect a capacitor between Pin 2 (V_{CC}) and Pin 3 (MUTE) so that the auto mute function operates during power-off.

Recommended value = 1μF

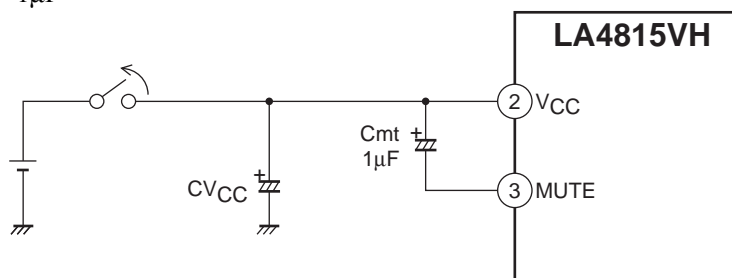

Figure 9

6. Input coupling capacitor (C_{in})

C_{in} is an input coupling capacitor, and is used for DC cutting. However, this capacitor is also used to improve the ripple rejection ratio, which changes according to the capacitance value (recommended value = 1μF). In addition, this capacitor also affects the transient response characteristics during power-on and when mute is canceled, so the constant should be set in consideration of these characteristics.

Design reference value = approximately 0.33 to 3.3μF

- Ripple rejection ratio : Increasing the capacitance value increases the rate, and reducing the value reduces the rate.
- Rise response speed : Increasing the capacitance value reduces the speed, and reducing the value increases the speed.
- Popping noise : Increasing the capacitance value reduces the noise, and reducing the value increases the noise.

7. Output coupling capacitor (C_{out})

C_{out} is an output coupling capacitor used for DC cutting. However, this capacitor, C_{out}, in combination with load impedance R_L forms a high-pass filter and attenuates the low frequency signals. Take into account the cutoff frequency when determining the capacitance value. In addition, normally a chemical capacitor is used for this capacitor, but the capacitance value of chemical capacitors decreases at low temperatures, so the value should be set in accordance with this characteristic.

The cutoff frequency is expressed by the following formula.

$$f_c = 1 / (2\pi \times R_L \times C_{out})$$

8. Output phase compensation capacitor (C_{osc})

The C_{osc} capacitor is used to prevent output oscillation. Use a ceramic capacitor (recommended value = 0.1μF) with good high frequency characteristics, and locate this capacitor as close to the IC as possible.

9. Power supply capacitor (C_{VCC})

The C_{VCC} capacitor is used to suppress the ripple component of the power supply line. Normally a chemical capacitor (recommended value = 10μF) is used for this capacitor. However, chemical capacitors have poor high frequency characteristics, so when using a CPU, DSP or other IC that generates digital noise in the set, it is recommended that a power supply bypass capacitor (ceramic capacitor, recommended value = approximately 0.1μF) be added to reject high-frequency components. Locate this bypass capacitor as close to the IC as possible.

10. NC pin treatment

Since the NC pins (pins 5 to 10) are connected to nothing internally, they may be left open. To increase the heat dissipation efficiency, however, it is recommended that the NC pins should be connected to the GND line.

LA4815VH

11. Signal mixing methods

The following methods can be used to mix a beep, key tone or other signal into the audio signal. Note that when input to Pin 4 is selected, amplification of signals input from Pin 4 changes according to impedance Z4 connected to Pin 13.

11-1. Mixing method using resistors in the Pin 13 input front end

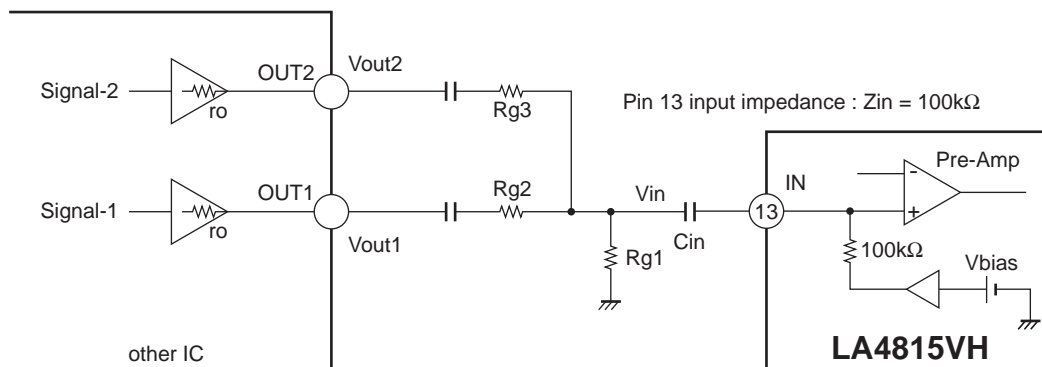

Figure 10

11-2. Method using input to Pin 4

- First signal system (Signal-1) voltage gain : Vg1

$$Vg1 = 20 \log (Vout/Vin1) = 20 \log (4 \times (125 + Z4) (500 + (125 \times Z4/(125 + Z4)))/(25 \times Z4))$$

$$* Z4 = R1 + ro$$
- Second signal system (Signal-2) voltage gain : Vg2

$$Vg2 = 20 \log (Vout/Vin2) = 20 \log (10000/(125 + R1))$$

$$* fc2 = 1/(2\pi \times Cin2 \times (R1 + 125))$$

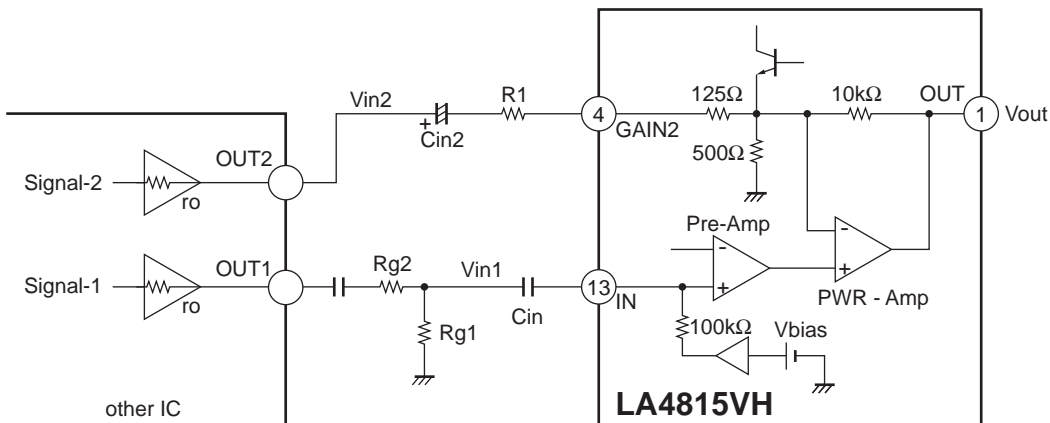

Figure 11

12. Short-circuit between pins

Turning on the power supply with some pins short-circuited may cause deterioration or breakdown. Therefore, when mounting the IC on a board, check to make sure that no short-circuit is formed between pins by solder or other foreign substances before turning on the power supply.

13. Load short circuit

Leaving the IC for a long time in the condition with a load short circuit may cause deterioration or breakdown. Therefore, never short-circuit the load.

14. Maximum ratings

When used under conditions near the maximum ratings, even a slight fluctuation in the conditions may cause the maximum ratings to be exceeded, possibly resulting in a breakdown or other accidents. Therefore, always provide enough margin for fluctuations in the supply voltage and other conditions, and use within a range not exceeding the maximum ratings.

LA4815VH

General characteristics (1)

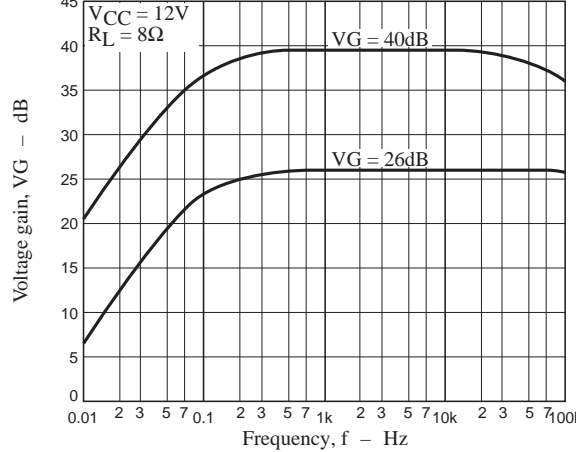
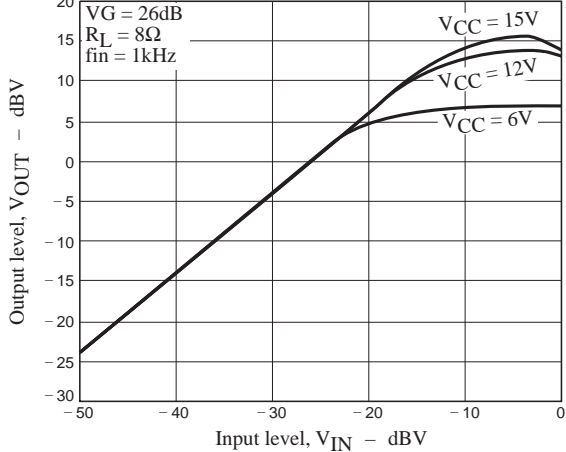
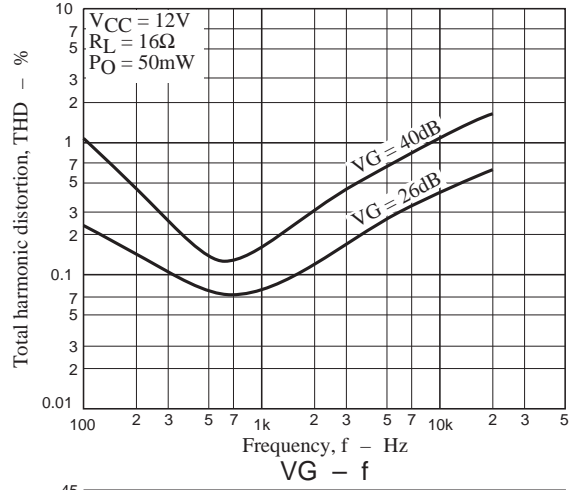
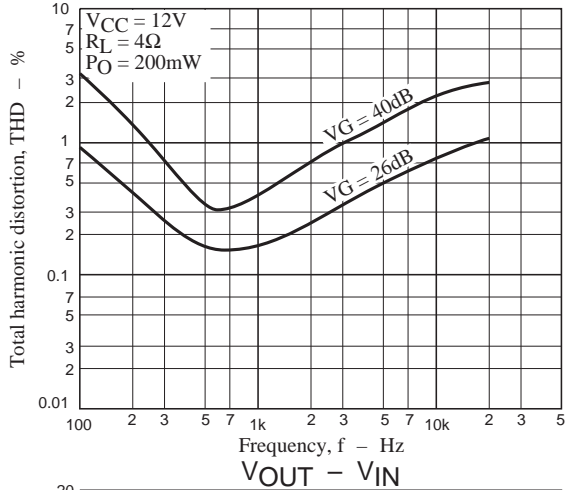
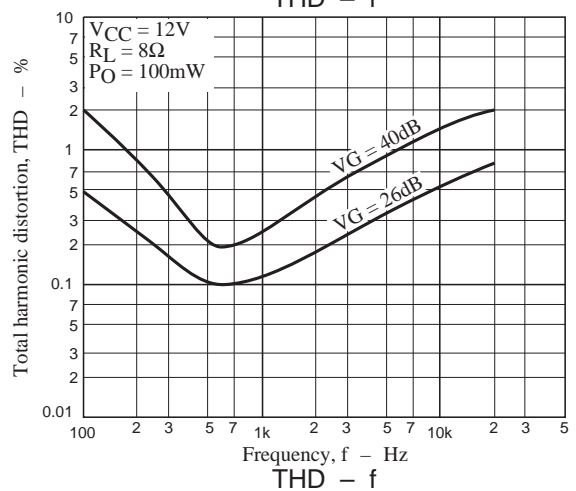
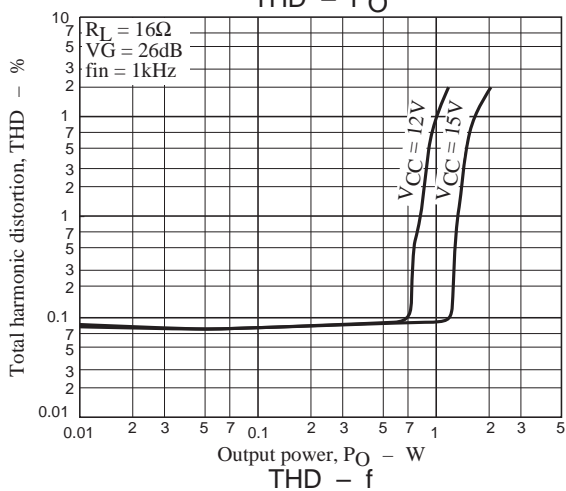
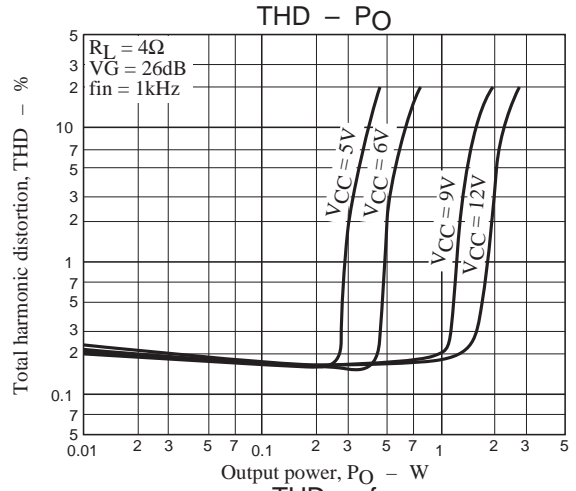
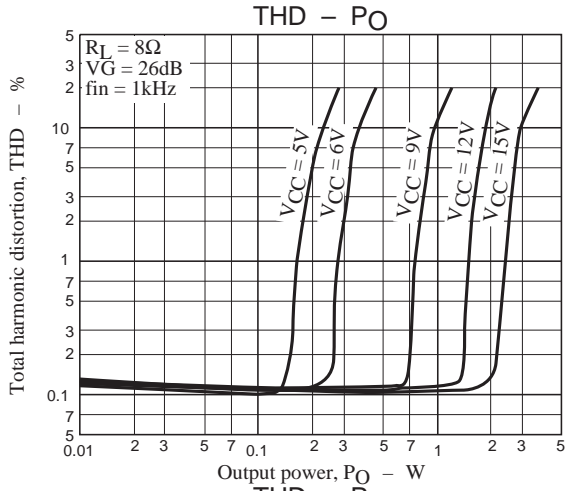

LA4815VH

General characteristics (2)

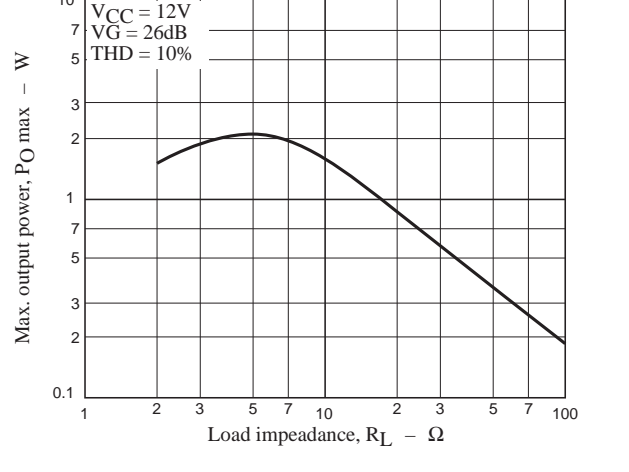
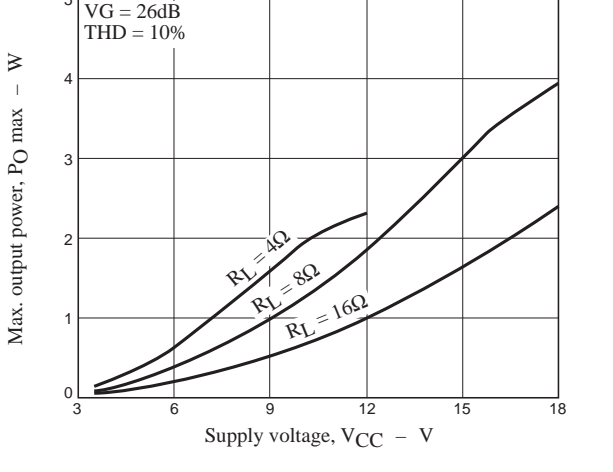
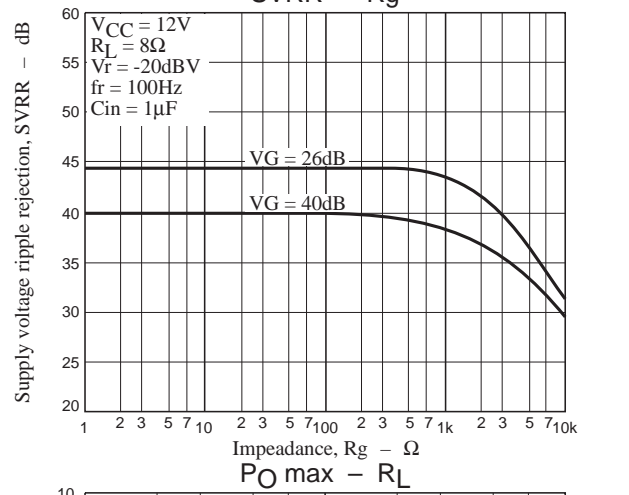
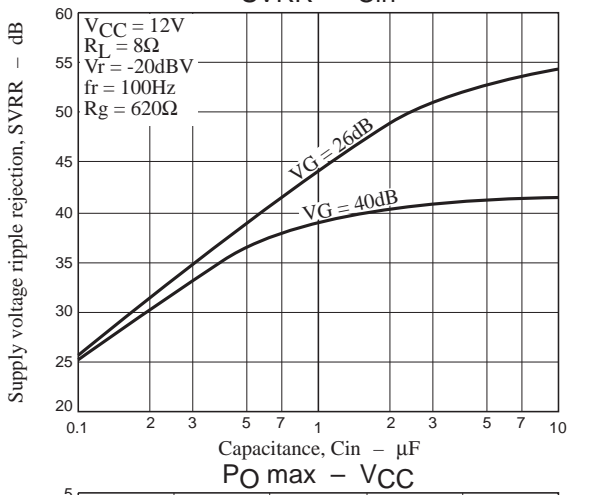
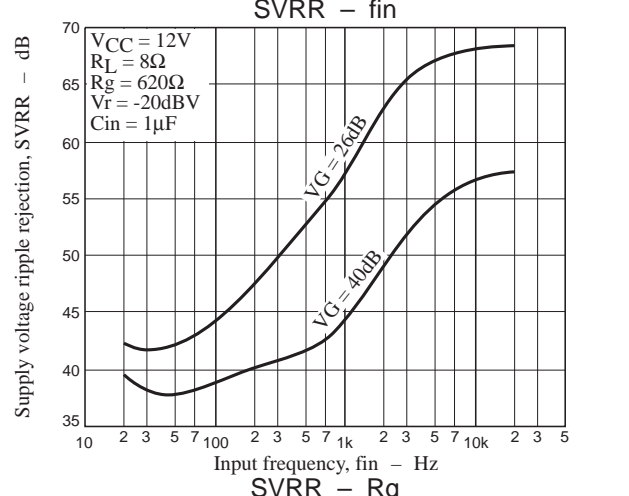
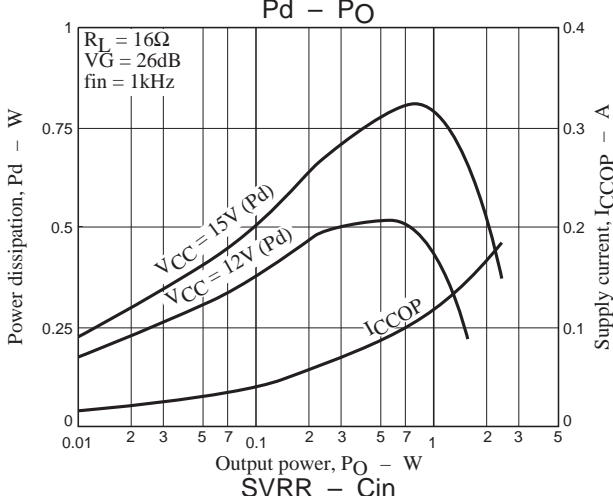
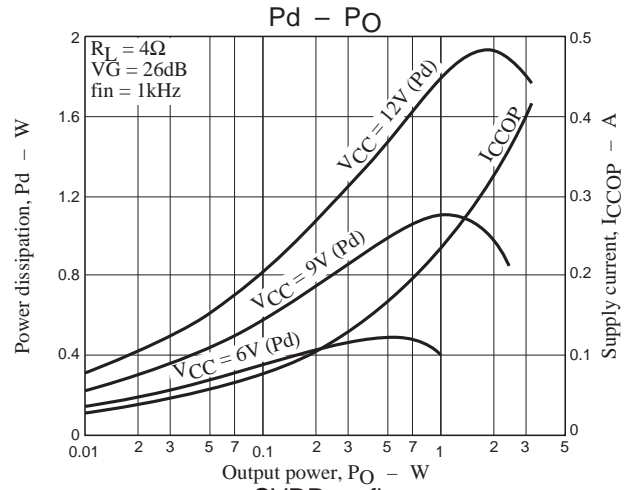
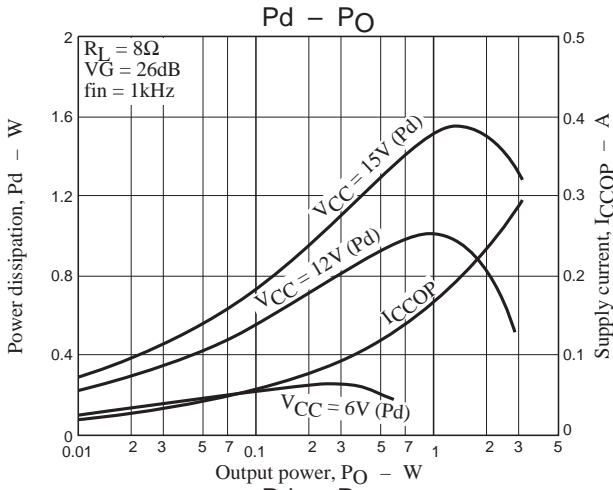

LA4815VH

General characteristics (3)

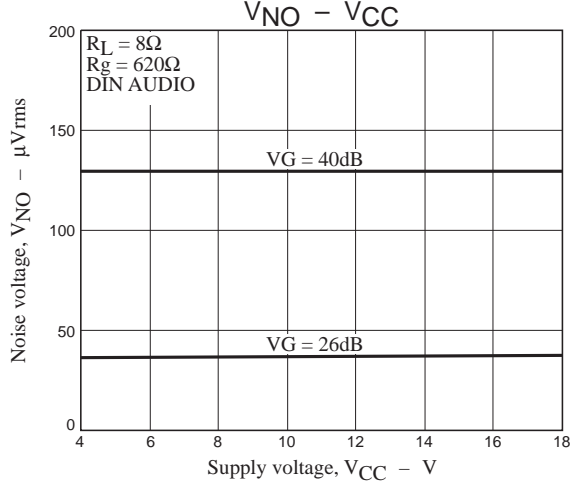
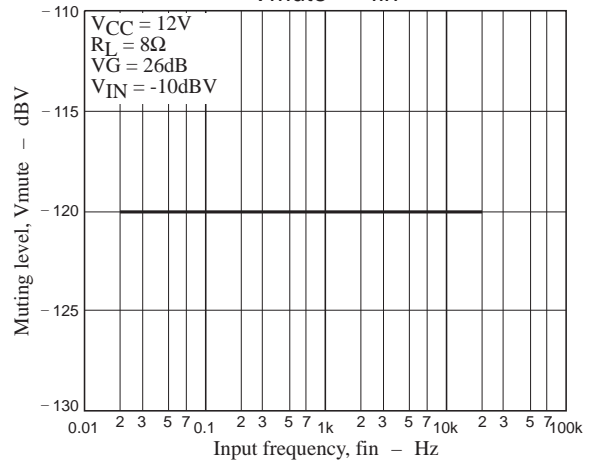
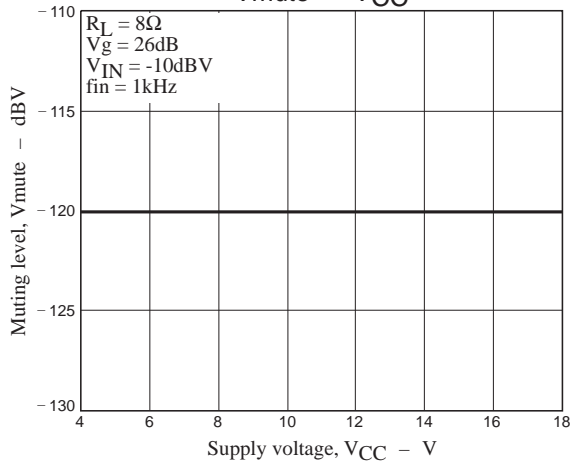
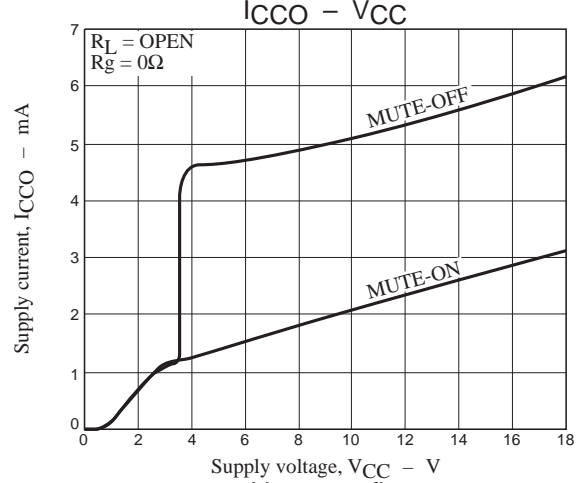
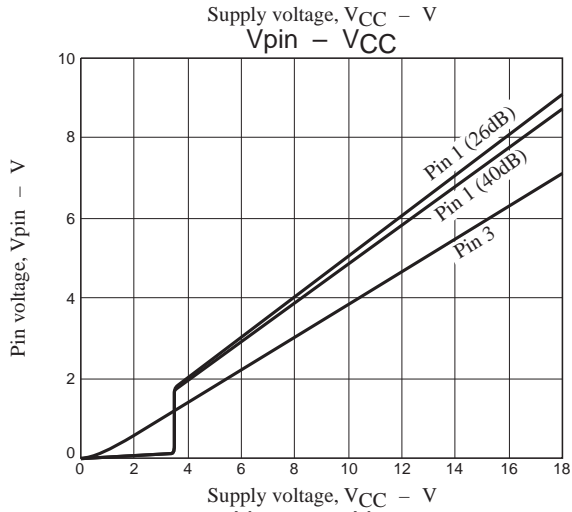
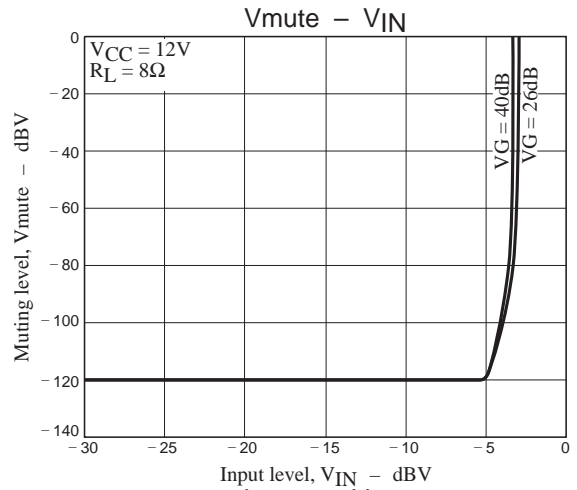
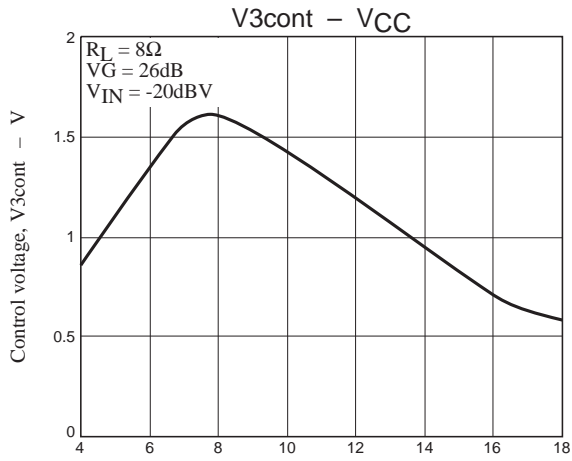

LA4815VH

Temperature characteristics (1)

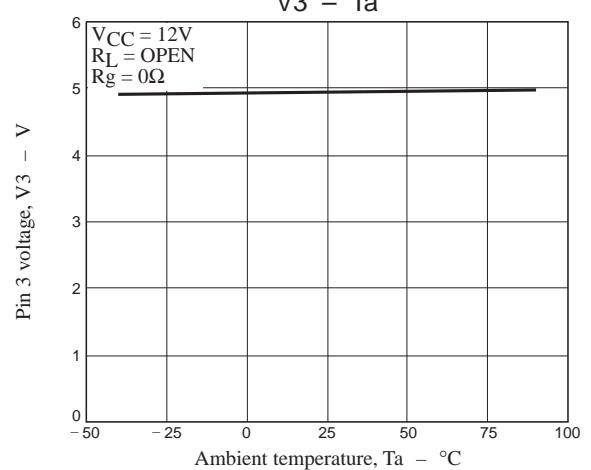
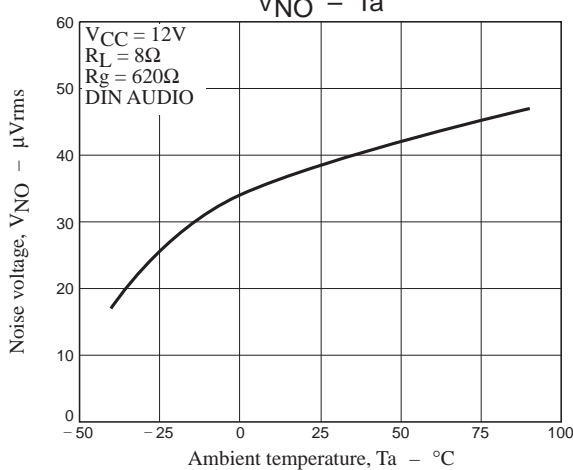
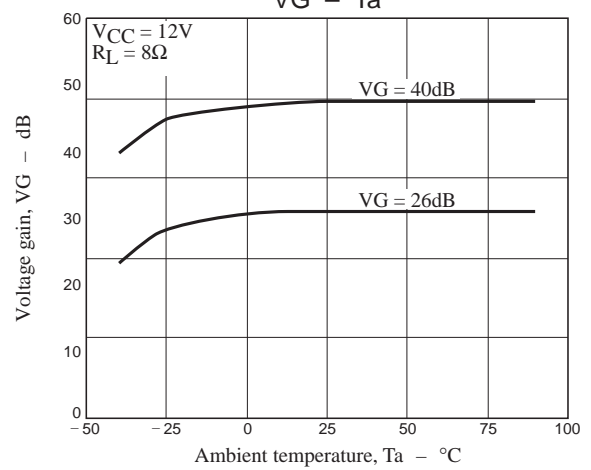
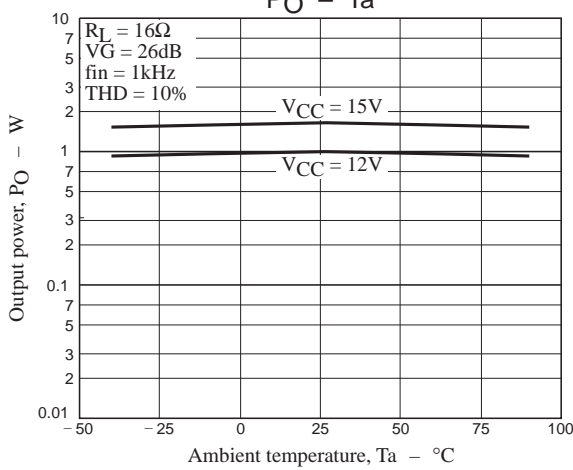
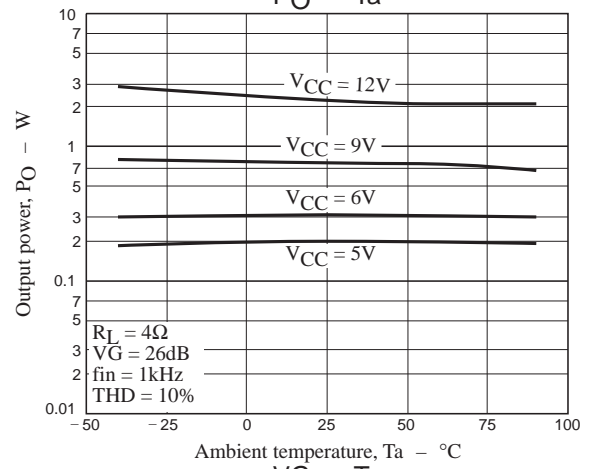
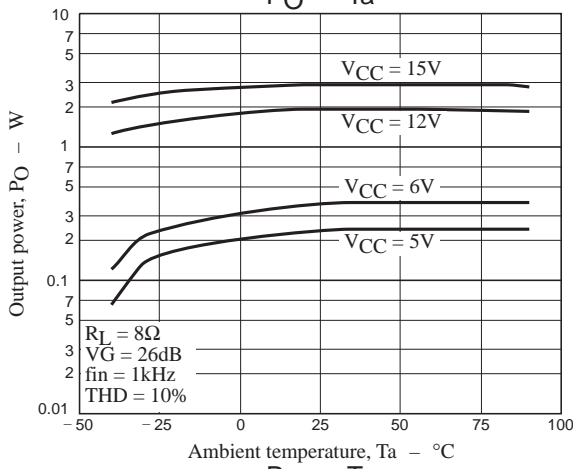
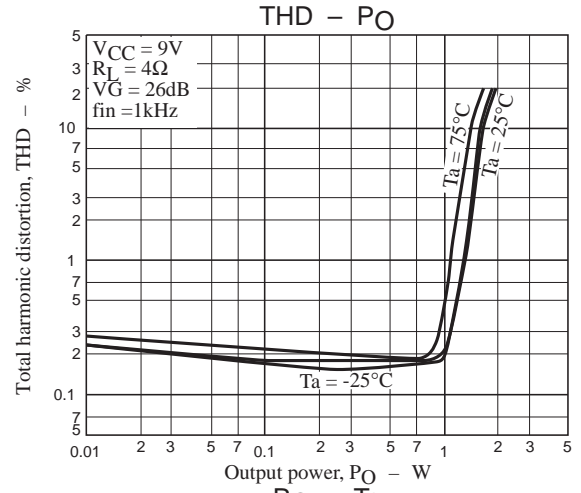
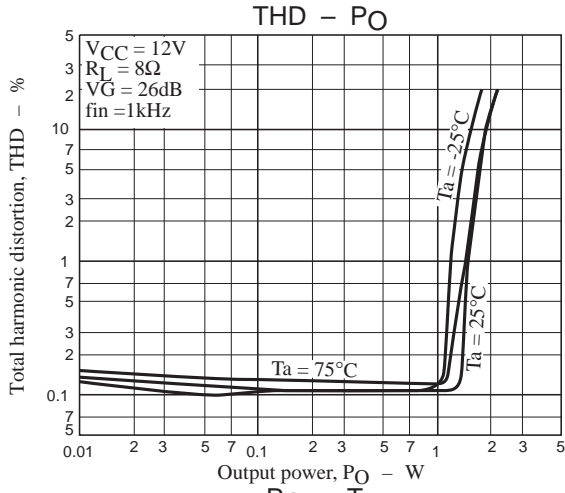

LA4815VH

Temperature characteristics (2)

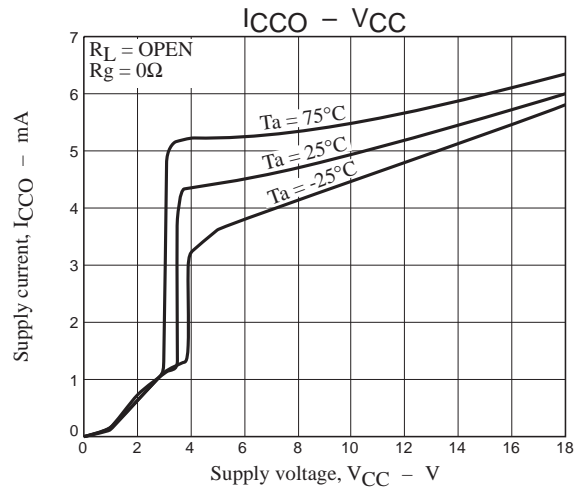
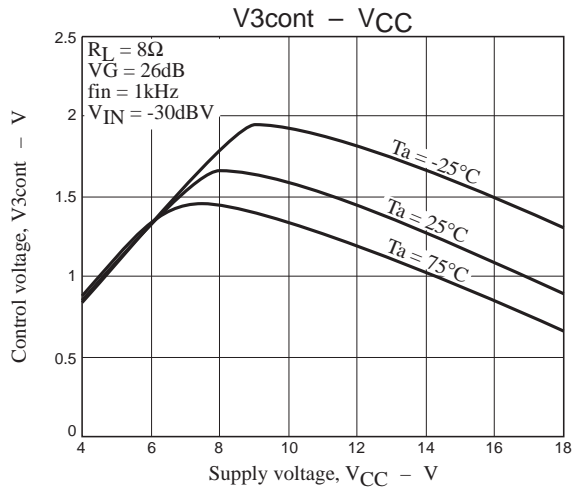

Muting on and off transient characteristics

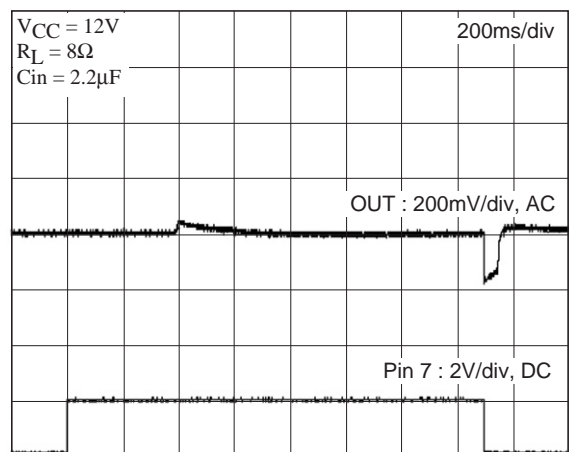
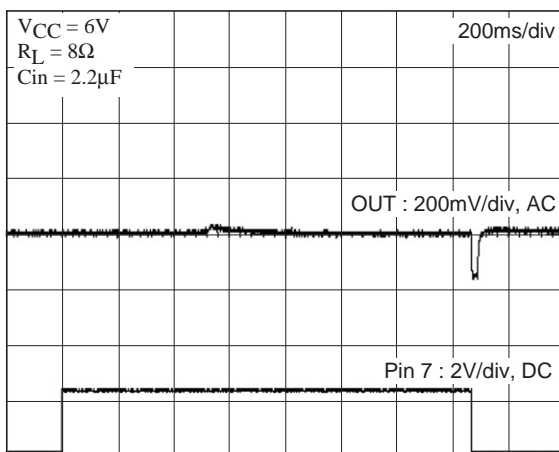
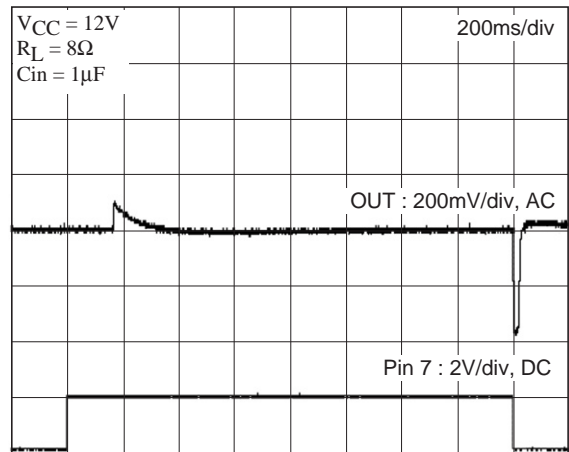
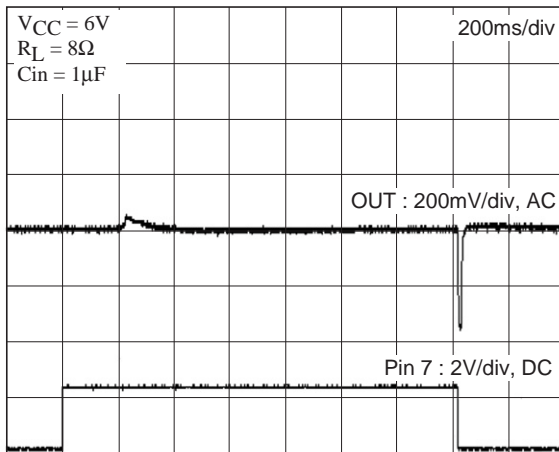

ON Semiconductor and the ON logo are registered trademarks of Semiconductor Components Industries, LLC (SCILLC). SCILLC owns the rights to a number of patents, trademarks, copyrights, trade secrets, and other intellectual property. A listing of SCILLC's product/patent coverage may be accessed at www.onsemi.com/site/pdf/Patent-Marking.pdf. SCILLC reserves the right to make changes without further notice to any products herein. SCILLC makes no warranty, representation or guarantee regarding the suitability of its products for any particular purpose, nor does SCILLC assume any liability arising out of the application or use of any product or circuit, and specifically disclaims any and all liability, including without limitation special, consequential or incidental damages. "Typical" parameters which may be provided in SCILLC data sheets and/or specifications can and do vary in different applications and actual performance may vary over time. All operating parameters, including "Typicals" must be validated for each customer application by customer's technical experts. SCILLC does not convey any license under its patent rights nor the rights of others. SCILLC products are not designed, intended, or authorized for use as components in systems intended for surgical implant into the body, or other applications intended to support or sustain life, or for any other application in which the failure of the SCILLC product could create a situation where personal injury or death may occur. Should Buyer purchase or use SCILLC products for any such unintended or unauthorized application, Buyer shall indemnify and hold SCILLC and its officers, employees, subsidiaries, affiliates, and distributors harmless against all claims, costs, damages, and expenses, and reasonable attorney fees arising out of, directly or indirectly, any claim of personal injury or death associated with such unintended or unauthorized use, even if such claim alleges that SCILLC was negligent regarding the design or manufacture of the part. SCILLC is an Equal Opportunity/Affirmative Action Employer. This literature is subject to all applicable copyright laws and is not for resale in any manner.