

### ELEM-5070F4F92838Z15-T4

Received	
<input type="checkbox"/>	MASS PRODUCTION
<input checked="" type="checkbox"/>	PRELIMINARY
<input type="checkbox"/>	CUSTOMER DESIGN
DEVICE NO. : DHE-000XXXX	
PAGE : 13	

Revised record		
REV.	DESCRIPTION	RELEASE DATE
1	New create	2014.07.25

## ELEM-5070F4F92838Z15-T4

PRELIMINARY

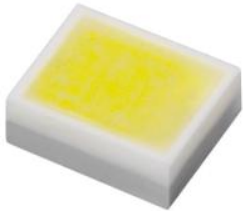

### Features

- Small & compact package and with high efficiency
- Typical luminous flux: 60 lm @ 150mA
- Typical color temperature: 6000K@150mA
- optical efficiency@150 mA : 121 lm/W
- ESD protection up to 8KV
- Grouping parameter: total luminous flux, color coordinates.
- RoHS compliant & Pb free.

### Applications

- Mobile Phone Camera Flash(Camera flash light /strobe light for mobile devices )
- Torch light for DV(Digital Video) application
- Indoor lighting applications
- Signal and symbol luminaries for orientation marker lights (e.g. steps, exit ways, etc.)
- TFT backlighting
- Exterior and interior illumination applications
- Decorative and Entertainment Lighting
- Exterior and interior automotive illumination

## Device Selection Guide

Chip Materials	Emitted Color
InGaN	White

## Absolute Maximum Ratings ( $T_{\text{solder pad}}=25^{\circ}\text{C}$ )

Parameter	Symbol	Rating	Unit
DC Forward Current (mA)	$I_F$	250	mA
Peak Pulse Current (mA) (50ms : ON , 950ms : OFF)	$I_{\text{Pulse}}$	500	mA
ESD Resistance	$V_B$	8000	V
Reverse Voltage	$V_R$	[1]	V
Junction Temperature	$T_J$	115	$^{\circ}\text{C}$
Operating Temperature	$T_{\text{Opr}}$	-40 ~ +85	$^{\circ}\text{C}$
Storage Temperature	$T_{\text{Stg}}$	-40 ~ +100	$^{\circ}\text{C}$
Power Dissipation (Pulse Mode)	$P_d$	1.7	W
Soldering Temperature	$T_{\text{Sol}}$	260	$^{\circ}\text{C}$
Allowable Reflow Cycles	n/a	2	cycles
Viewing Angle <sub>(2)</sub>	$2\theta_{1/2}$	120	deg

Note:

1. The ELEM series LEDs are not designed for reverse bias used
2. View angle tolerance is  $\pm 5^{\circ}$
3. Avoid operating ELEM series LEDs at maximum operating temperature exceed 1 hour.
4. All specification are assured by reliability test for 1000hr, IV degradation less than 30%.
5. All reliability items are tested under good thermal management with 1.0x 1.0 cm<sup>2</sup> MCPCB.
6. Peak pulse current shall be applied under conditions as max duration time 50ms and max duty cycle 10%.
7. Operate LED component at maximum rating conditions continuously will cause possible permanent damage and de-rating parameters. Exercise multiple maximum rating parameters simultaneously should not be allowed. When maximum rating parameters are applied over a long period will result potential reliability issue.

**Electro-Optical Characteristics (T<sub>solder pad</sub> =25°C)**

Parameter	Symbol	Min.	Typ.	Max.	Unit	Condition
Luminous Flux <sub>(1)</sub>	Φ <sub>v</sub>	45	60	----	lm	I <sub>F</sub> =150mA
Forward Voltage <sub>(2) (3)</sub>	V <sub>F</sub>	2.85	3.4	3.85	V	
Correlated Color Temperature	CCT	5000	----	7000	K	

Parameter	Symbol	Min.	Typ.	Max.	Unit	Condition
Luminous Flux <sub>(1)</sub>	Φ <sub>v</sub>	90	120	----	lm	I <sub>F</sub> =350mA
Forward Voltage <sub>(2) (3)</sub>	V <sub>F</sub>	2.95	3.6	4.15	V	
Correlated Color Temperature	CCT	5000	----	7000	K	

Note:

1. Luminous flux measurement tolerance: ±10%
2. Forward voltage measurement tolerance: ±0.1V
3. Electric and optical data is tested at 50 ms pulse condition.
4. The data of luminous flux measured at thermal pad=25°C

**Bin Range of Forward Voltage Binning**

Bin Code	Min.	Typ.	Max.	Unit	Condition
2832	2.85	----	3.25	V	I <sub>F</sub> =150mA
3235	3.25	----	3.55		
3538	3.55	----	3.85		

**Bin Range of Luminous Intensity**

Bin Code	Min.	Typ.	Max.	Unit	Condition
F4	45	----	52	lm	I <sub>F</sub> =150mA
F5	52	----	60		
F6	60	----	70		
F7	70	----	80		
F8	80	----	90		
F9	90	----	100		

### White Bin Structure

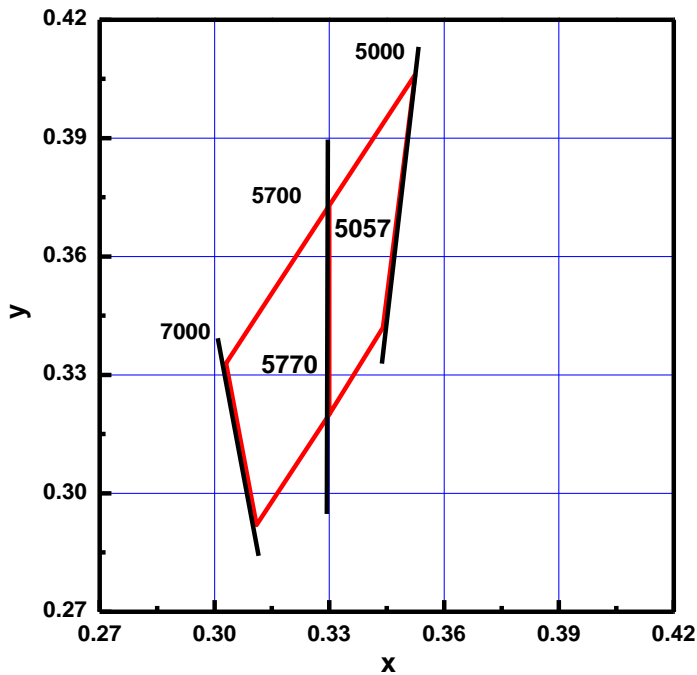

Notes :

- 1.Color Bin (1) : 5057K
- 2.Color Bin (2) : 5770K

### White Bin Coordinate

Bin	CIE-X	CIE-Y	CCT Reference Range
5057	0.3300	0.3200	5000K ~ 5700K
	0.3300	0.3730	
	0.3440	0.3420	
	0.3524	0.4061	
5770	0.3030	0.3330	5700K ~ 7000K
	0.3300	0.3730	
	0.3300	0.3200	
	0.3110	0.2920	

Note:

1. Color coordinates measurement allowance :  $\pm 0.01$
2. Color bins are defined at IF=150mA and 50ms pulse operation condition.

### Typical Electro-Optical Characteristics Curves

Relative Spectral Distribution, IF=150mA@50ms, T<sub>solder pad</sub>=25°C

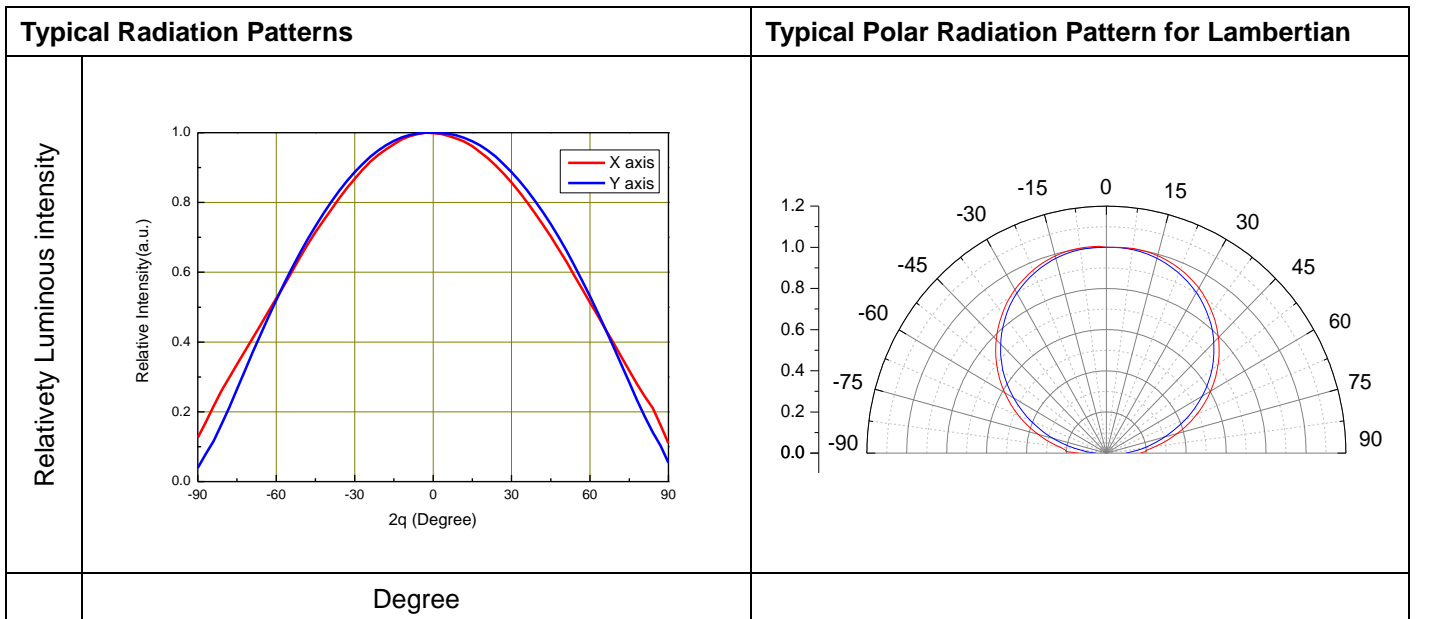
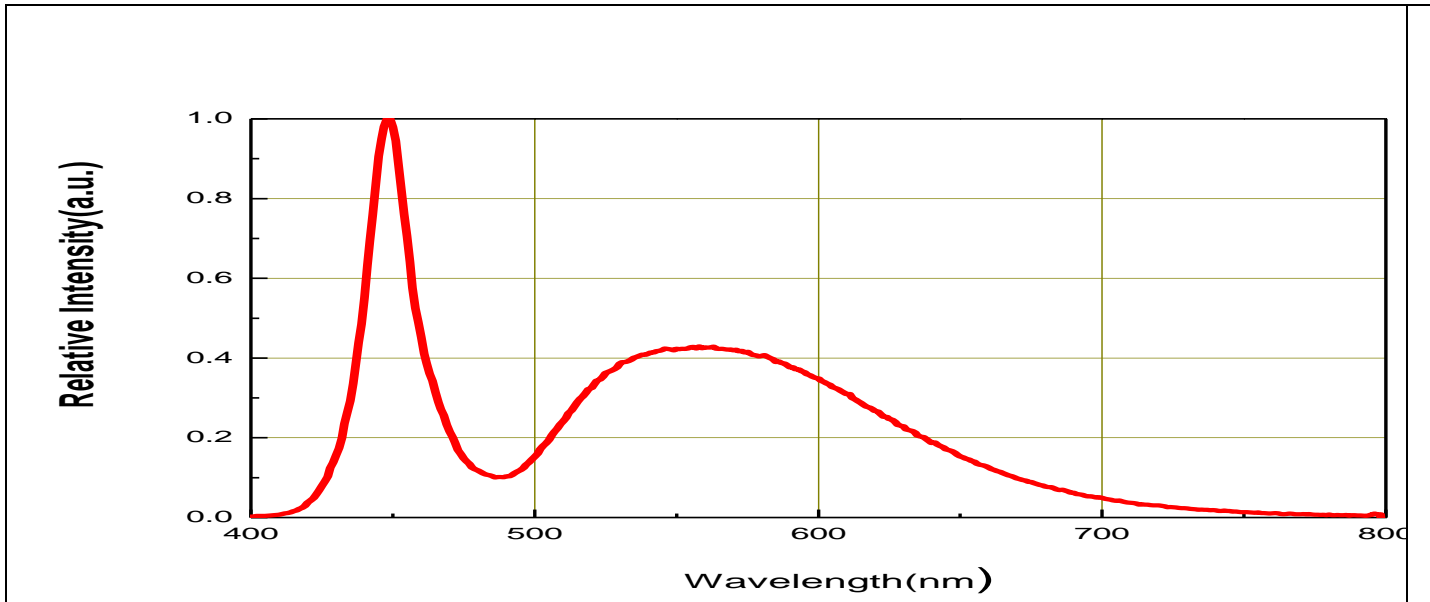

Note:

1.  $2\theta_{1/2}$  is the off axis angle from lamp centerline where the luminous intensity is 1/2 of the peak value.
2. View angle tolerance is  $\pm 5^\circ$ .

**Forward Voltage vs Forward Current,**  
 $T_{\text{solder pad}} = 25^{\circ}\text{C}$

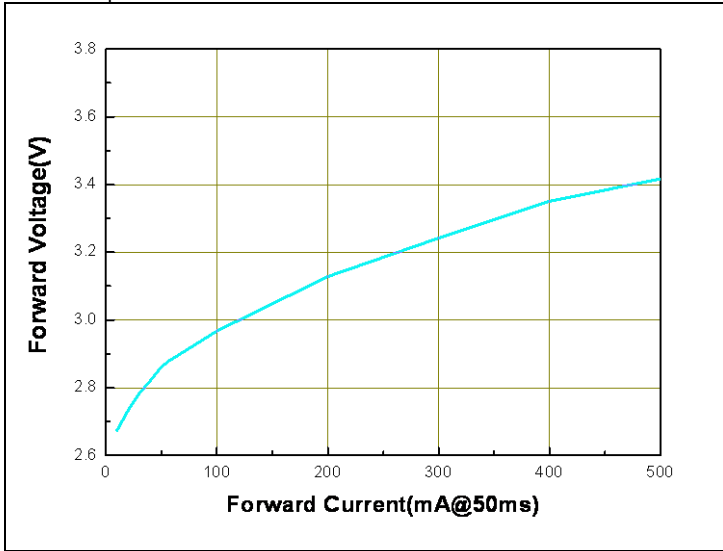

**Correlated Color Temperature(CCT) vs. Forward Current**

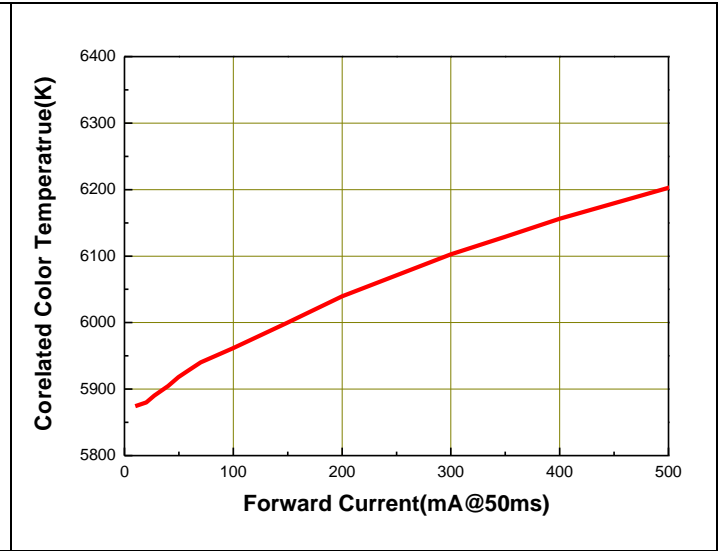

**Luminous Flux vs Forward Current,**  
 $T_{\text{solder pad}} = 25^{\circ}\text{C}$

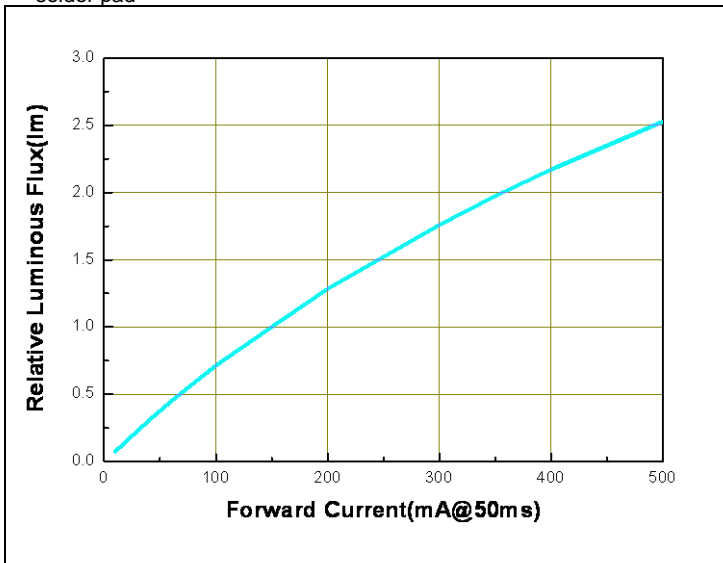

**Forward Current Derating Curve, Derating based on**  
 $T_{j\text{MAX}} = 115^{\circ}\text{C}$  at torch mode

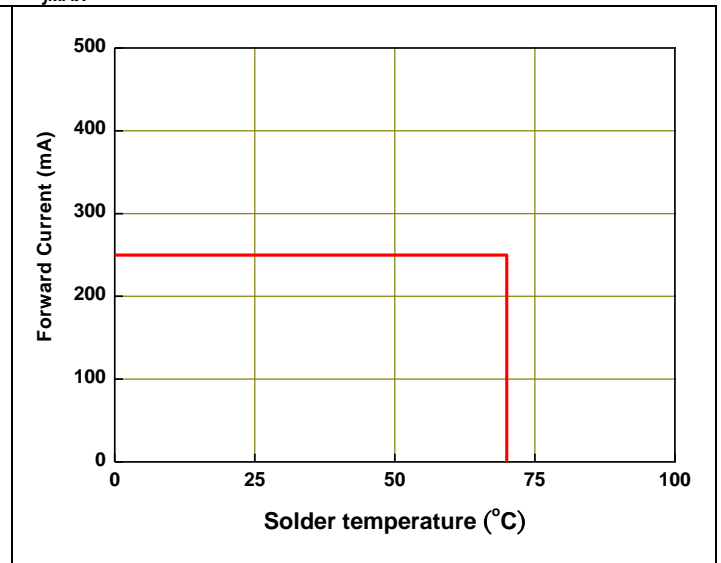

Note:

1. All correlation data is tested under superior thermal management with 1.0x 1.0 cm<sup>2</sup> MCPCB

## Package Dimension

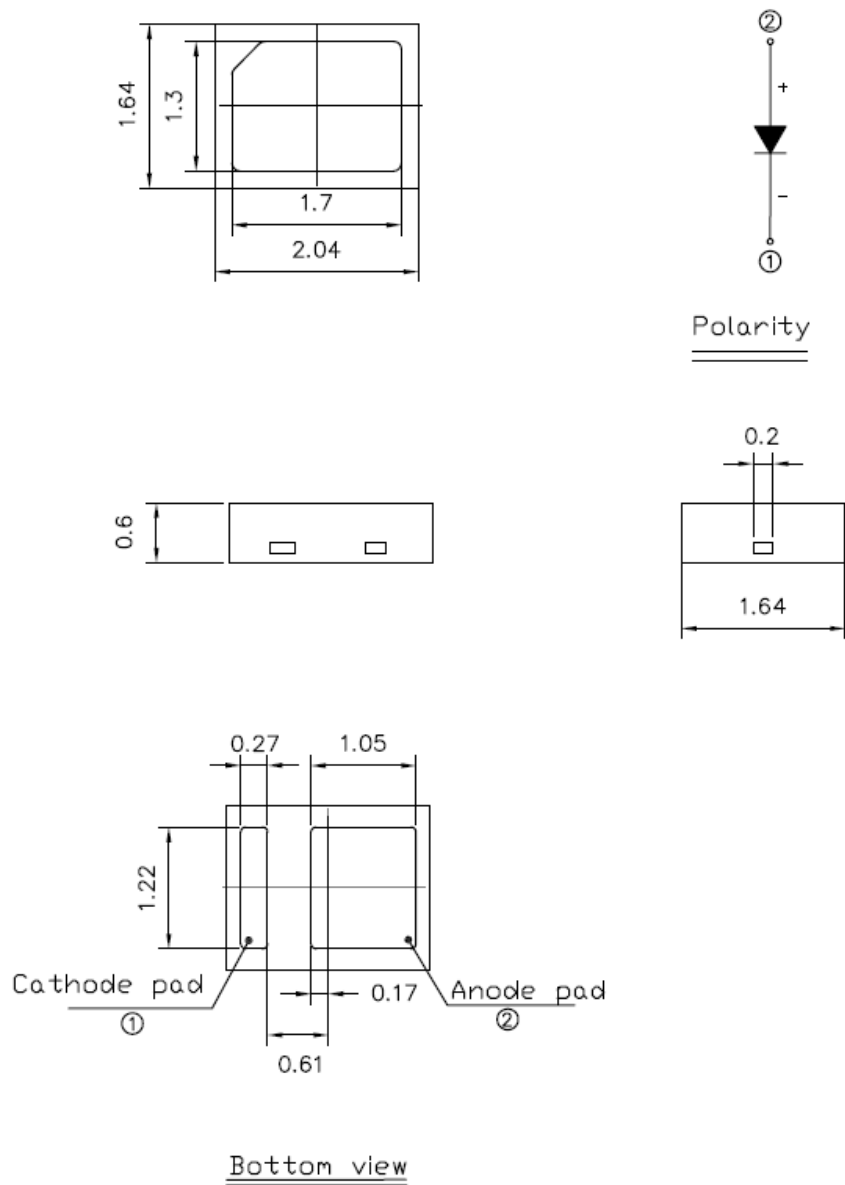

### Note:

1. Dimensions are in millimeters.
2. Tolerances unless mentioned are  $\pm 0.1\text{mm}$ .
3. The thermal pad is electrically unity from the Anode and contact pads.
4. Do not handle the device by the lens. Incorrect force applied to the lens may lead to the failure of devices.



## Moisture Resistant Packing Materials

### Label Explanation



- CPN: Customer Specification (when required)
- P/N: Everlight Production Number
- QTY: Packing Quantity
- CAT: Luminous Flux (Brightness) Bin
- HUE: Color Bin
- REF: Forward Voltage Bin
- LOT No: Lot Number

## Carrier Tape Dimensions: Loaded Quantity 2000 pcs Per Reel

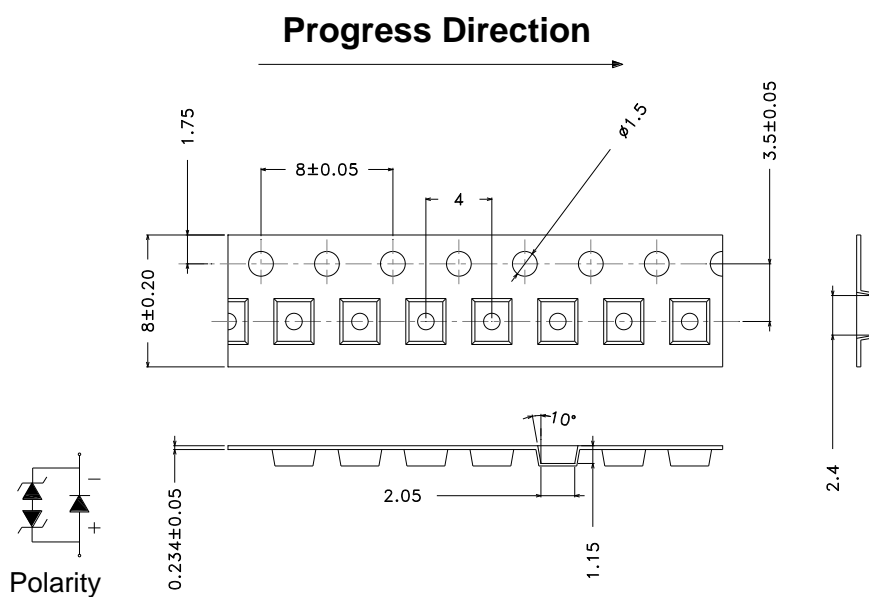

### Note:

1. Dimensions are in millimeters.
2. Tolerances unless mentioned are  $\pm 0.1$  mm.

### Reel Dimensions

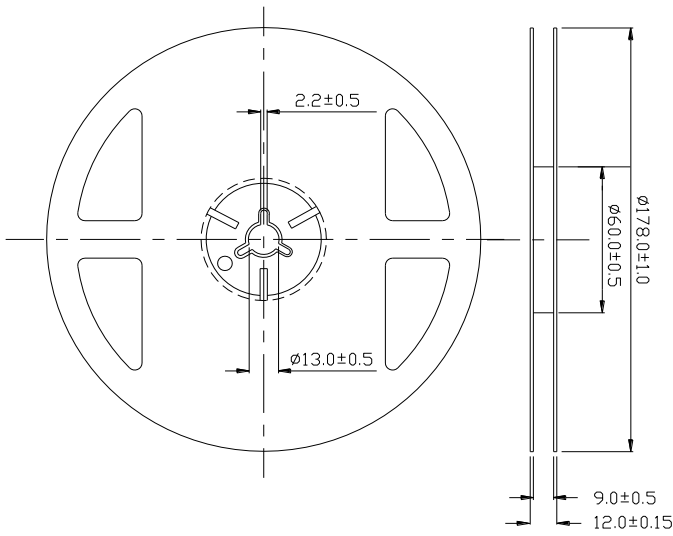

#### Note:

1. Dimensions are in millimeters.
2. Tolerances for fixed dimensions are  $\pm 0.1$ mm.

### Moisture Resistant Packing Process

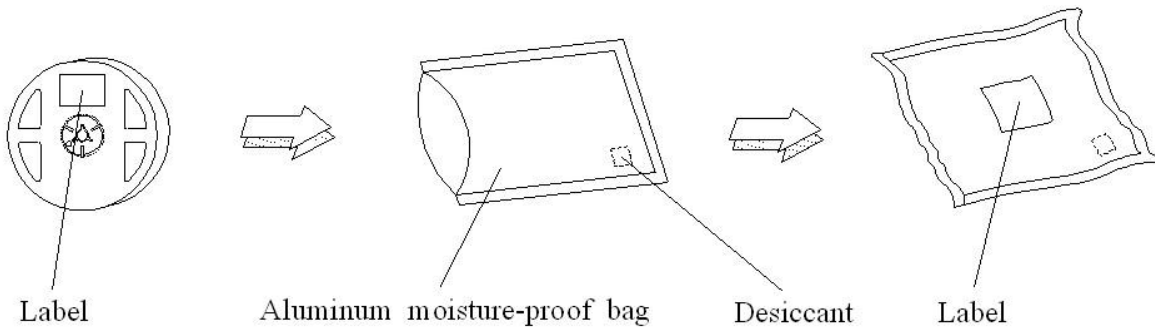

## Reflow Soldering Characteristics

### Soldering and Handling

#### 1. Over-current-proof

Customer must apply resistors for protection; otherwise slight voltage shift will cause big current change (Burn out will happen).

#### 2. Storage

- i. Before the package is opened: The LEDs should be stored at 30°C or less and 50%RH or less after being shipped from Everlight. The storage life is 6 months. If the LEDs are to be stored for more than 6 months, they should be stored in a sealed container with a nitrogen atmosphere and moisture absorbent material.
- ii. After opening the package: The LED's should be stored under 30°C or less and 30%RH or less. The LED should be used within 168hrs (7days) after opening the package. If unused LEDs remain, they should be stored in moisture proof packages. After opening the package, the LEDs should be stored at temperature less than 30°C and relative humidity less than 85%.
- iii. Before using LEDs: The LEDs should be baked under the following conditions: pre-curing at 60±5°C for 24 hours
- iv. Do not stack assemblies containing Everlight ELEM LEDs to prevent damage to the optical surface of LEDs. Forces applied to the optical surface may result in the surface being damaged.

#### 3. Soldering Condition

##### i. Soldering Pad

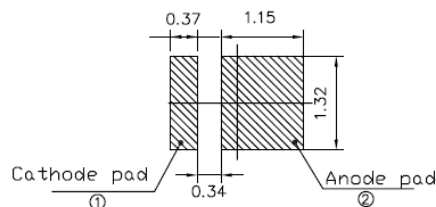

##### Solder pad

##### ii. Pb-free solder temperature profile

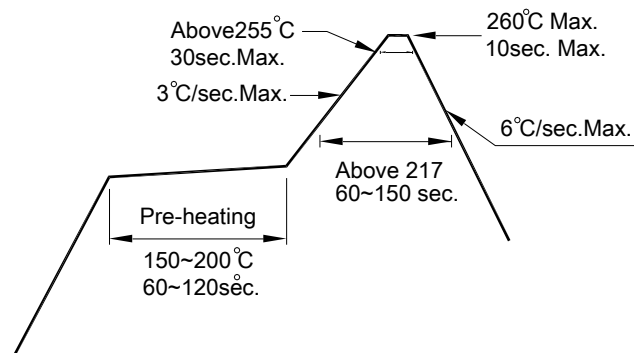

- iii. Reflow soldering should not be done more than two times.
- iv. When soldering, do not put stress on the LEDs during heating.
- v. After soldering, do not warp the circuit board.

#### 4. Soldering Iron

Each terminal is to go to the tip of soldering iron temperature less than 350°C for 3 seconds within once in less than the soldering iron capacity 25W. Leave two seconds and more intervals, and do soldering of each terminal. Be careful because the damage of the product is often started at the time of the hand solder.

#### 5. Repairing

Repair should not be done after the LEDs have been soldered. When repairing is unavoidable, a double-head soldering iron should be used (as below figure). It should be confirmed beforehand whether the characteristics of the LEDs will or will not be damaged by repairing.

